



















---

# PRICE LIST

# 2023

---

ENGLISH € VAT EXCLUDED

<b>01</b>	<b>WRENCHES</b>	<b>16</b>	
<b>02</b>	<b>SOCKET WRENCHES</b>	<b>29</b>	
<b>03</b>	<b>SCREWDRIVERS &amp; PLIERS</b>	<b>77</b>	
<b>04</b>	<b>INSULATED TOOLS</b>	<b>99</b>	
<b>05</b>	<b>TORQUE TOOLS</b>	<b>115</b>	
<b>06</b>	<b>PERCUSSION TOOLS</b>	<b>123</b>	
<b>07</b>	<b>CUTTING TOOLS</b>	<b>129</b>	
<b>08</b>	<b>PULLERS</b>	<b>143</b>	
<b>09</b>	<b>MEASURING TOOLS</b>	<b>153</b>	
<b>10</b>	<b>PNEUMATIC TOOLS</b>	<b>159</b>	
<b>11</b>	<b>AUTOMOTIVE</b>	<b>177</b>	
<b>12</b>	<b>GENERAL MAINTENANCE</b>	<b>269</b>	
<b>13</b>	<b>PLUMBING TOOLS</b>	<b>281</b>	
<b>14</b>	<b>TOOL BAGS</b>	<b>285</b>	
<b>15</b>	<b>TOOL TROLLEYS, WORKBENCHES</b>	<b>303</b>	
<b>16</b>	<b>TECHNICAL FURNITURE</b>	<b>365</b>	
<b>17</b>	<b>PROFESSIONAL EQUIPMENT</b>	<b>433</b>	

# The NEWS of the catalogue

# 2023

Also this year we are improving our offer with new products, increasingly efficient and dedicated to professionals in specific sectors.

## WE EXPAND THE RANGE

The search for innovative, practical and functional solutions drives us every year to extend our offer, with an increasingly vast and complete assortment. The new pliers are the right tools for today's increasingly specialized professional.

## WE SPOTLIGHT THE INNOVATIONS OF THE SECTOR

With the right light, everything can change. The professional to whom our new collection of lamps, dedicated to the car body shops, is aimed, knows it well. In day-to-day work, support tools need to be portable, versatile, but also precise and high-performing. It's not enough to illuminate, sometimes you have to make it shine!

## WE RAISE THE STANDARDS

With the new lifters, including the new models with a lowered design, we have also raised the standards and now it is easier to work, even on vehicles with a high capacity, such as off-road vehicles and vans. Our new proposals have a high height compared to the market average and the pedal-less lifting mechanism ensures more ease of use with less effort.



# NEW PLIERS – INDUSTRIAL

New high performance tools enrich the offer of Fasano Tools pliers already present in the catalogue. The **NEW LINE of INDUSTRIAL PLIERS** is characterized by ease of use and effective performance too in the heaviest applications.

## 20+ MODELS

**CUTTING CAPACITY UP TO 6mm\***

IT REFERS TO THE MAXIMUM VALUE COVERED BY THE RANGE

**HARDNESS  
STEEL HRC 63**

## HIGH LEVERAGE

### LET'S LEVERAGE ON SPECIFIC PROFESSIONAL NEEDS

In the range of **INDUSTRIAL GRIPPERS** the versions High Leverage have a **"HIGH LEVERAGE EFFECT"** which guarantees greater comfort during use and a significant reduction in hand effort.



**+ 25% CUTTING CAPACITY  
- 35% OF EFFORT\***

THE FULCRUM POSITIONED  
CLOSER TO THE CUTTING EDGES  
AND MORE DISTANT FROM  
TO THE HANDLE POSITION

**GLOSSY MIRROR FINISH**

**BI-MATERIAL  
HANDLE**

**INCREASE THE LEVERAGE EFFECT,  
GREATLY REDUCING  
THE EFFORT DURING USE.**

\* Cutting of the piano wire of the model **FG 59/HL200** compared to the model **FG 59/XT200**



# HYDRAULIC TROLLEY JACKS

## 3 New models

Even higher performance and ever less effort.  
Yes, with the new Fasano Tools hydraulic jacks!

**NEW LOW PROFILE DESIGN** in 2 models  
to work also on heavy or sports vehicles.

**NEW LIFTING MECHANISM WITHOUT FOOT PEDAL**  
which reduces the effort of use and increases the stability in lifting.

**NEW PUMPING SYSTEM**  
equipped with double piston to facilitate weight lifting.

**MAX HEIGHT**  
higher than other models on the market.



**STURDY METAL  
CONSTRUCTION**



**HANDLE WITH  
SHOCKPROOF RUBBER**



**PURGE VALVE  
OF THE AIR**

# NEW LED LAMPS FOR COLOR CONTROL

The range of Fasano Tools lamps and spotlights is enriched with new, even more performing proposals dedicated to the Bodywork Sector. Portable, rotating, adjustable and tiltable, our lamps adapt to maneuvering spaces and to your work, like never before!

## MORE LIGHT, MORE PRECISION

The most durable over time, even with bad weather and external agents.  
 The most resistant to shocks.  
 The most suitable for jobs to be carried out outdoors.  
 The best to return a realistic view of the color related to the painting.

## NEW PRODUCTS

## CAR BODY SECTOR

# LED LAMPS

### ADJUSTABLE IN INTENSITY AND IN THE COLOR TEMPERATURE



Discover them all in the section  
**12 MAINTENANCE  
 GENERAL**

DEGREE OF PROTECTION

**IP65**

IMPACT RESISTANCE LEVEL

**IK07**

HIGH COLOR RENDERING INDEX

**CRI 96+**

 **COB LED - cri 96+**  
**3 COLORS**

2700K 4500K 6500K



# The company

## Identity

### We manufacture professional tools since 1976

Founded in 1976, the company launched the FASANO TOOLS brand in 2002 which, right from the start, placed itself on the market as an innovative and alternative brand in the world of professional tools.

The production and logistics activities are concentrated in the operational headquarters of approximately 3,000 square meters, located in Lecce, Italy.

Over 40 years of experience and continuous listening to users and business partners, have allowed the company to grow and become a reference reality in the sector, consolidate its presence at a national level and strengthen that at an international level.

Fasano Tools products are aimed at professionals in the **Industry, Automotive and Handicraft** sectors.

Subject to rigorous quality controls, tools and equipments are characterized by high performance in terms of power, great reliability over time, as well as compactness and manageability, essential for effective use.





Fasano Tools stands out on the market for the **wide range of work tools** that cover all the reference sectors and for the wide and constant availability of spare parts. The strengths of our company are, in fact, the assistance and attention to the voluntary and mandatory certifications to which the products are promptly submitted, in order to comply with international standards as per current regulations.

Fundamental support for the activity of Fasano Tools is its **website**, extraordinarily rich in product information, detailed technical data sheets, manuals, spare parts list and innovative tools to find the tool or kit you need for your job. Like the Tool Finder, a revolutionary internal search engine dedicated to the range of engine timing products.

The communication of Fasano Tools also extends from the web to the world of Social media, where it is characterized by a targeted and different activity for each Channel.

With over 40 years of experience, the company has a very clear **VISION.**

It aims to never lose that critical spirit towards the world and the market and, through constant commitment and the search for innovations to support work, to face the challenges of the sector with flexibility and to anticipate its evolution. **Today like yesterday.**



# The Team

## A mosaic of professional collaborators is our wealth

Variety is our real strength. Different professionalisms and specific skills make up our team.

Our family.

The Fasano Tools organization chart consists of departments constantly communicating with each other: Management, Administration, Accounting, Sales Department, Production Department, Design Department, Research and Development Area, Creative Marketing Area.

We like to work in a team with well-defined roles, embracing our vision in every smallest activity, but also keeping in mind the objectives to be achieved. Offer ever more performing work tools able to adapt to any situation.

The **MISSION** of Fasano Tools is implemented by offering constant customer support and concrete answers to solve any critical issue promptly and efficiently.

## Our network

### The Fasano network in the world!

Fundamental to the business development was the creation of a solid network which, over the years, has been made up of quality collaborations and partnerships.

Fasano Tools boasts, in fact, a dense network of distributors at national level and a consolidated presence with many importers, **in over 30 countries around the world.**

Our network is also made up of commercial agencies whose constant and widespread presence on the territory ensures the promotion, demonstration and relative application of the products in the workplace. Furthermore, thanks to the work of our specialized Technical Promoters, an important listening and feedback activity is carried out from customers, as well as targeted assistance.

**40** years of experience

**30** countries we export to

**6000** products in the Catalogue

**3000mq** production and logistics site

# The digital network

## We communicate our passion online

We live the worldwide web with creativity, communicating all the passion we put into our work, but also future projects, news and collaborations.

[fasanotools.com](http://fasanotools.com)

Our website is constantly updated and it is an important point of reference for customers and resellers who personalize their virtual experience by accessing it through the reserved area. The portal offers the entire catalog of our references, promotions, detailed services, new products and contacts. Each tool is accompanied by precise information, technical data sheets and a list of the related spare parts available.

Also thanks to the innovative **TOOL FINDER**, users of the Automotive sector have the possibility to search, in a simple and fast way, the necessary engine timing kit, based on the vehicle.

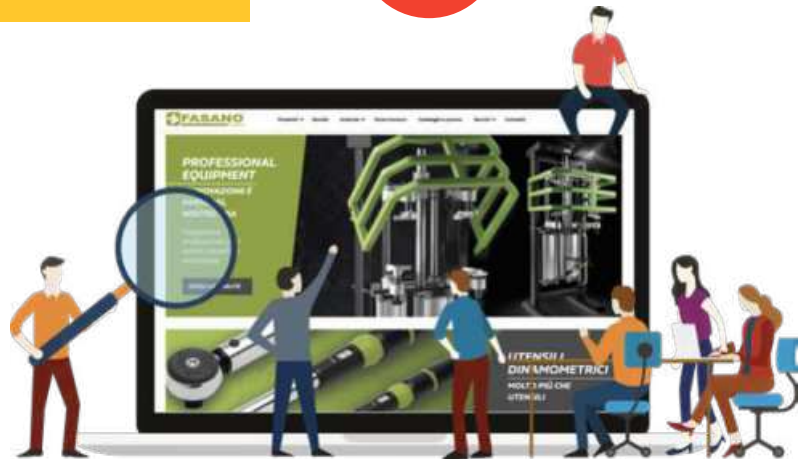

Our presence on **Social Media** aims to establish a relationship of trust with our public, based on transparency and its very participation in our activities. In particular, on **Facebook** we involve our users, customers and fans of the sector, with information, videos, images and dedicated contests.

**Our Youtube channel** is populated day by day with demonstration videos, in-depth videos or related to our participation in events. We use our **Linkedin** channel to communicate specific content to experts and professionals in the sector. Finally, on Instagram, we communicate our reality on a daily basis, showing the background of the design, of the creative processes, such as the new products located in the reference context.

On this worldwide channel, the **hashtag #fasanotools** also gives a voice to our customers and partners, showing all the nuances of a great reality such as Fasano Tools.



**TOOL FINDER**  
CHOOSE YOUR ENGINE TIMING KIT

**Compact**

**Powerful**

**Durable**



## The products

### A recipient for each tool

Fasano Tools produces tools and equipment for professionals, sector specialists and hobbyists in love with their passion. Each product is designed for the specific reference area, in order to make the instrument even more performing. Thanks to listening to the market, over the decades the company has been able to constantly renew the offer in the catalog, and **today it boasts more than 6,000 references divided into 17 product families.**

## Core Business



## The Target

We produce tools for different fields, with one unique goal: do your job better using the best tools.



### INDUSTRY

Resistant and guaranteed tools, to reach high quality standards.



### CRAFTS

Our tools and equipment for the various sectors of craftsmanship.



### AUTOMOTIVE

Unique and dedicated tools, designed to solve any daily challenge.

# The best of made in Italy

## Customize your workspaces!

Fasano Tools products are the result of intense research, development and internal design work.

The wide range of products we offer is characterized by attention and attention to detail, but also by style and design.

RAL 7021



RAL 9016



RAL 6018



RAL 5002



RAL 3001



# Be different

The workbenches, grids, cabinets and all the elements of technical furniture by Fasano Tools, allow the customization of the workspaces according to the different professional needs.

**Our 100% Made in Italy tool trolleys are manufactured in different models and colors.**

And with the sets of tools present in the assortment inside the drawer units, there is no limit to functionality.



**MADE IN ITALY**



**POWER SOCKETS**  
- 220V 2-POLE SOCKET  
- 2-POLE SHUKO SOCKET  
- USB SOCKET



**OIL DISTRIBUTION MODULE, EQUIPPED WITH 2 DIGITAL GUN LITER COUNT**

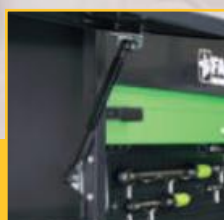

**WALL UNITS EQUIPPED WITH GAS PISTON TO FACILITATE THE OPENING DOORS**



**WASTE COMPARTMENT MOUNTED ON SLIDING GUIDES**



**STAINLESS STEEL WORKTOP AND COLLECTION TANK REMOVABLE**



**DRAWERS ABLE TO SUITABLE FOR TOOLS' FORMS**

## Innovative services

We stand out on the market by offering maximum attention to customers

## AVAILABILITY OF PRODUCTS

Our warehouse boasts a wide range of products ready for delivery.  
98% of deliveries are fully processed.



## FAST SHIPPING SERVICE

Thanks to the wide availability of products, 90% of orders are processed no later than 24/48 hours.



24/48h

# Research and Development

## New technologies at the service of work

Fasano Tools has always been careful to the new needs of the market and aims to offer new products that are peculiar for their function, but also for the design and technology used.

To do this, the Research and Development department is constantly engaged in the study of **innovative solutions** that can make work ever easier and results even more efficient.

# Quality and Assistance

Fasano products meet **high quality standards and guarantee high performance in terms of performance, durability and relative repetition of actions over time.**

Proud of our products, we guarantee the continuous availability of spare parts over time, as well as **constant and punctual assistance.**



## TECHNOLOGICAL INNOVATION



**DIGITAL DISPLAY**

It displays the compression force impressed on the spring in real time.



**SELF-CENTERING SYSTEM**

2 self-centering arms that ensure positioning optimal and centered shock absorber, in safety

## SHOCK ABSORBER REMOVER

Fasano Tools has passed the safety checks required by the European Directives on CE certification, relying on the prestigious international TUV Sud laboratory





01

**WRENCHES**





## Combination wrenches 12PT

- DIN 3113



CODE	mm	L/mm	€/Pz
FG 600/B5.5	5.5	105	<b>6,50</b>
FG 600/B6	6	105	<b>6,50</b>
FG 600/B7	7	115	<b>6,70</b>
FG 600/B8	8	125	<b>7,00</b>
FG 600/B9	9	135	<b>7,10</b>
FG 600/B10	10	145	<b>7,30</b>
FG 600/B11	11	155	<b>8,10</b>
FG 600/B12	12	165	<b>8,60</b>
FG 600/B13	13	175	<b>8,70</b>
FG 600/B14	14	185	<b>10,20</b>
FG 600/B15	15	195	<b>11,50</b>
FG 600/B16	16	205	<b>12,10</b>
FG 600/B17	17	215	<b>12,80</b>
FG 600/B18	18	225	<b>13,50</b>
FG 600/B19	19	235	<b>14,00</b>
FG 600/B20	20	245	<b>15,30</b>
FG 600/B21	21	255	<b>16,50</b>
FG 600/B22	22	265	<b>17,20</b>
FG 600/B23	23	275	<b>18,50</b>
FG 600/B24	24	285	<b>19,40</b>

CODE	mm	L/mm	€/Pz
FG 600/B25	25	295	<b>20,50</b>
FG 600/B26	26	305	<b>22,00</b>
FG 600/B27	27	315	<b>23,50</b>
FG 600/B28	28	325	<b>24,50</b>
FG 600/B29	29	335	<b>26,00</b>
FG 600/B30	30	345	<b>28,50</b>
FG 600/B32	32	365	<b>31,50</b>
FG 600/B34	34	380	<b>49,00</b>
FG 600/B36	36	410	<b>60,00</b>
FG 600/B38	38	430	<b>70,00</b>
FG 600/B41	41	460	<b>82,00</b>
FG 600/B46	46	500	<b>110,00</b>
FG 600/B50	50	540	<b>165,00</b>
FG 600/B55	55	560	<b>260,00</b>
FG 600/B60	60	600	<b>340,00</b>
FG 600/B65	65	680	<b>440,00</b>
FG 600/B70	70	680	<b>490,00</b>
FG 600/B75	75	730	<b>570,00</b>
FG 600/B80	80	730	<b>660,00</b>



## Set of combination wrenches in carton box

CODE	Pz	CONTENT	€/Pz
FG 600/SC17	17	6, 7, 8, 9, 10, 11, 12, 13, 14, 15, 16, 17, 18, 19, 20, 21, 22 mm	<b>175,00</b>
FG 600/SC16	16	6, 7, 8, 10, 12, 13, 14, 16, 17, 19, 21, 22, 24, 27, 30, 32 mm	<b>225,00</b>
FG 600/SC25	25	6, 7, 8, 9, 10, 11, 12, 13, 14, 15, 16, 17, 18, 19, 20, 21, 22, 23, 24, 25, 26, 27, 28, 30, 32 mm	<b>375,00</b>

## Set of combination wrenches with plastic holder

CODE	Pz	CONTENT	€/Pz
FG 600/ST7	7	8, 10, 11, 13, 14, 17, 19 mm	<b>75,00</b>
FG 600/ST9	9	8, 10, 11, 12, 13, 14, 15, 17, 19 mm	<b>95,00</b>
FG 600/ST11	11	8, 9, 10, 11, 12, 13, 14, 15, 16, 17, 19 mm	<b>116,00</b>

## Set of combination wrenches in nylon pouch

CODE	Pz	CONTENT	€/Pz
FG 600/SP6	6	8, 10, 13, 14, 17, 19 mm	<b>70,00</b>
FG 600/SP9	9	8, 10, 11, 12, 13, 14, 15, 17, 19 mm	<b>99,00</b>
FG 600/SP11	11	8, 9, 10, 11, 12, 13, 14, 15, 16, 17, 19 mm	<b>120,00</b>

Chiave combinata poligonale extra lunghe  
- DIN 3113

CODE	mm	L/mm	€/Pz
FG 600/L10	10	207	<b>10,80</b>
FG 600/L11	11	225	<b>11,30</b>
FG 600/L12	12	243	<b>12,10</b>
FG 600/L13	13	260	<b>12,50</b>
FG 600/L14	14	280	<b>13,50</b>

CODE	mm	L/mm	€/Pz
FG 600/L15	15	297	<b>14,50</b>
FG 600/L16	16	315	<b>15,50</b>
FG 600/L17	17	333	<b>16,60</b>
FG 600/L18	18	340	<b>17,80</b>
FG 600/L19	19	350	<b>19,00</b>



## Set of combination wrenches in carton box

CODE	Pz	CONTENT	€/Pz
FG 600L/SC10	10	10, 11, 12, 13, 14, 15, 16, 17, 18, 19 mm	<b>150,00</b>

## Chiave combinata poligonale in pollici

- DIN 3113



CODE	Pollici	L/mm	€/Pz	CODE	Pollici	L/mm	€/Pz
FG 600/IN1	1/4"	105	<b>7,00</b>	FG 600/IN11	7/8"	265	<b>17,50</b>
FG 600/IN2	5/16"	125	<b>7,50</b>	FG 600/IN12	15/16"	285	<b>19,50</b>
FG 600/IN3	3/8"	145	<b>8,50</b>	FG 600/IN13	1"	295	<b>21,00</b>
FG 600/IN4	7/16"	155	<b>8,80</b>	FG 600/IN14	1.1/16"	315	<b>24,00</b>
FG 600/IN5	1/2"	175	<b>10,20</b>	FG 600/IN15	1.1/8"	335	<b>27,60</b>
FG 600/IN6	9/16"	185	<b>10,80</b>	FG 600/IN16	1.1/4"	365	<b>31,50</b>
FG 600/IN7	5/8"	205	<b>12,70</b>	FG 600/IN17	1.5/16"	380	<b>39,00</b>
FG 600/IN8	11/16"	215	<b>13,00</b>	FG 600/IN18	1.3/8"	410	<b>49,50</b>
FG 600/IN9	3/4"	235	<b>13,90</b>	FG 600/IN19	1.7/16"	410	<b>50,00</b>
FG 600/IN10	13/16"	255	<b>16,00</b>	FG 600/IN20	1.1/2"	430	<b>60,00</b>



### Set of combination wrenches in carton box

CODE	Pz	CONTENT	€/Pz
FG 600IN/SC13	13	1/4", 5/16", 3/8", 7/16", 1/2", 9/16", 5/8", 11/16", 3/4", 13/16", 7/8", 15/16", 1"	<b>172,00</b>



### Set of combination wrenches in nylon pouch

CODE	Pz	CONTENT	€/Pz
FG 600IN/SP6	6	1/4", 5/16", 7/16", 1/2", 9/16", 11/16"	<b>68,00</b>
FG 600IN/SP9	9	1/4", 5/16", 3/8", 7/16", 1/2", 9/16", 5/8", 11/16", 3/4"	<b>105,00</b>
FG 600IN/SP11	11	1/4", 5/16", 3/8", 7/16", 1/2", 9/16", 5/8", 11/16", 3/4", 13/16", 1"	<b>142,00</b>

## Chiave a forchetta semplice

- DIN 894



CODE	mm	L/mm	€/Pz	CODE	mm	L/mm	€/Pz
FG 601/B10	10	120	<b>7,00</b>	FG 601/B27	27	215	<b>17,80</b>
FG 601/B11	11	120	<b>7,00</b>	FG 601/B28	28	240	<b>20,00</b>
FG 601/B12	12	120	<b>7,00</b>	FG 601/B30	30	240	<b>20,00</b>
FG 601/B13	13	145	<b>7,50</b>	FG 601/B32	32	270	<b>26,00</b>
FG 601/B14	14	145	<b>8,10</b>	FG 601/B34	34	270	<b>26,00</b>
FG 601/B15	15	145	<b>9,20</b>	FG 601/B35	35	296	<b>27,00</b>
FG 601/B16	16	160	<b>9,20</b>	FG 601/B36	36	296	<b>27,50</b>
FG 601/B17	17	160	<b>9,20</b>	FG 601/B38	38	296	<b>28,50</b>
FG 601/B18	18	160	<b>9,20</b>	FG 601/B41	41	335	<b>33,00</b>
FG 601/B19	19	175	<b>10,80</b>	FG 601/B46	46	370	<b>43,00</b>
FG 601/B20	20	175	<b>10,80</b>	FG 601/B50	50	410	<b>66,00</b>
FG 601/B21	21	175	<b>10,80</b>	FG 601/B55	55	488	<b>84,00</b>
FG 601/B22	22	195	<b>14,00</b>	FG 601/B60	60	488	<b>86,00</b>
FG 601/B23	23	195	<b>14,00</b>	FG 601/B65	65	488	<b>98,00</b>
FG 601/B24	24	195	<b>14,00</b>	FG 601/B70	70	595	<b>130,00</b>
FG 601/B25	25	215	<b>17,80</b>	FG 601/B75	75	595	<b>145,00</b>
				FG 601/B80	80	595	<b>185,00</b>





### Double open end wrenches - DIN 3110

CODE	mm	L/mm	€/Pz
FG 602/B6x7	6x7	123	<b>4,30</b>
FG 602/B8x9	8x9	140	<b>4,50</b>
FG 602/B8X10	8x10	140	<b>5,20</b>
FG 602/B10X11	10x11	156	<b>5,20</b>
FG 602/B12X13	12x13	172	<b>5,60</b>
FG 602/B14X15	14x15	190	<b>6,80</b>
FG 602/B16X17	16x17	204	<b>7,90</b>
FG 602/B18X19	18x19	221	<b>9,10</b>
FG 602/B20X22	20x22	237	<b>11,50</b>
FG 602/B21X23	21x23	247	<b>13,00</b>

CODE	mm	L/mm	€/Pz
FG 602/B22X24	22x24	247	<b>13,00</b>
FG 602/B24X26	24x26	255	<b>14,50</b>
FG 602/B25X28	25x28	279	<b>16,50</b>
FG 602/B27X29	27x29	279	<b>18,00</b>
FG 602/B30X32	30x32	298	<b>19,00</b>
FG 602/B34X36	34x36	350	<b>43,00</b>
FG 602/B35X38	35x38	350	<b>56,00</b>
FG 602/B36X41	36x41	380	<b>57,00</b>
FG 602/B41X46	41x46	415	<b>72,00</b>
FG 602/B46X50	46x50	465	<b>86,00</b>



Set of double open end wrenches with plastic holder

CODE	Pz	CONTENT	€/Pz
FG 602/ST7	7	6x7, 8x9, 10x11, 12x13, 14x15, 16x17, 18x19mm	<b>49,00</b>
FG 602/ST9	9	6x7, 8x9, 10x11, 12x13, 14x15, 16x17, 18x19, 20x22, 21x23	<b>73,00</b>

Set of double open end wrenches with nylon pouch

CODE	Pz	CONTENT	€/Pz
FG 602/SP6	6	6x7, 8x9, 10x11, 12x13, 14x15, 16x17	<b>42,00</b>
FG 602/SP9	9	6x7, 8x9, 10x11, 12x13, 14x15, 16x17, 18x19, 20x22, 21x23	<b>76,00</b>
FG 602/SP13	13	6x7, 8x9, 10x11, 12x13, 14x15, 16x17, 18x19, 20x22, 21x23, 24x26, 25x28, 27x29, 30x32	<b>152,00</b>

Set of double open end wrenches in carton box

CODE	Pz	CONTENT	€/Pz
FG 602/SC8	8	6x7, 8x9, 10x11, 12x13, 14x15, 16x17, 18x19, 20x22 mm	<b>56,00</b>
FG 602/SC13	13	6x7, 8x9, 10x11, 12x13, 14x15, 16x17, 18x19, 20x22, 21x23, 24x26, 25x28, 27x29, 30x32 mm	<b>140,00</b>

### Double open end wrenches inch version - DIN 3110

CODE	Inch	L/mm	€/Pz
FG 602/IN1	5/16 x 3/8	140	<b>5,50</b>
FG 602/IN2	3/8 x 7/16	156	<b>6,50</b>
FG 602/IN3	7/16 x 1/2	172	<b>7,20</b>
FG 602/IN4	1/2 x 9/16	180	<b>7,70</b>
FG 602/IN5	9/16 x 5/8	190	<b>8,30</b>
FG 602/IN6	5/8 x 11/16	204	<b>10,30</b>

CODE	Inch	L/mm	€/Pz
FG 602/IN7	11/16 x 3/4	221	<b>11,80</b>
FG 602/IN8	3/4 x 7/8	255	<b>13,50</b>
FG 602/IN9	15/16 x 1	255	<b>18,50</b>
FG 602/IN10	1 x 1.1/8	279	<b>21,50</b>
FG 602/IN11	1.1/8 x 1.1/4	298	<b>23,50</b>



Set of double open end wrenches with nylon pouch

CODE	Pz	CONTENT	€/Pz
FG 602IN/SP9	9	5/16x3/8, 3/8x7/16, 7/16x1/2, 1/2x9/16, 9/16x5/8, 5/8x11/16, 3/4x7/8, 15/16x1, 1x1.1/8, 1.1/8x1.1/4 (IN1, IN2, IN3, IN4, IN6, IN8, IN9, IN10, IN11)	<b>115,00</b>



**Double open end wrenches - ultra slim model**

CODE	mm	L/mm	€/Pz
FG 602/C6x7	6x7	145	<b>5,00</b>
FG 602/C8x9	8x9	171	<b>5,00</b>
FG 602/C10x11	10x11	171	<b>5,50</b>
FG 602/C12x13	12x13	205	<b>6,50</b>
FG 602/C14x15	14x15	205	<b>7,20</b>
FG 602/C16x17	16x17	246	<b>10,20</b>
FG 602/C18x19	18x19	265	<b>10,50</b>
FG 602/C20x22	20x22	283	<b>14,00</b>
FG 602/C21x23	21x23	283	<b>14,00</b>



**Set of double open end wrenches with nylon pouch**

CODE	Pz	CONTENT	€/Pz
FG 602C/SP6	6	6x7,8x9,x10x11,x12x13,14x15,16x17	<b>49,00</b>
FG 602C/SP9	9	6x7,8x9,x10x11,x12x13,14x15,16x17,18x19,20x22,21x23	<b>90,00</b>



**Double end box wrenches**

CODE	mm	€/Pz	CODE	mm	€/Pz
FG 609/A8x10	8x10	<b>11,30</b>	FG 609/A15x17	15x17	<b>21,00</b>
FG 609/A10x12	10x12	<b>12,20</b>	FG 609/A16x18	16x18	<b>21,50</b>
FG 609/A11x13	11x13	<b>14,80</b>	FG 609/A19x22	19x22	<b>25,20</b>
FG 609/A14x17	14x17	<b>18,20</b>			

**Torx combination wrench**

CODE	Inch	L/mm	€/Pz
FG 600/E6x8	E6 x E8	112.4	<b>9,50</b>
FG 600/E10x12	E10 x E12	140.7	<b>10,20</b>
FG 600/E14x18	E14 x E18	183.0	<b>11,00</b>
FG 600/E20x24	E20 x E24	225.0	<b>15,00</b>



**Set of 5 double end box wrenches**

CODE	€/Pz
FG 609A/S5	<b>95,00</b>

10x12, 11x13,  
14x17, 16x18, 19x22



**Set of 4 Torx wrenches**

CODE	€/Pz
FG 600E/S4	<b>49,00</b>

E6xE8, E10xE12,  
E14xE18, E20xE24

**Double combination wrenches - DIN 838**



CODE	mm	L/mm	€/Pz
FG 615/B6x7	6x7	172	<b>8,20</b>
FG 615/B8x9	8x9	185	<b>8,90</b>
FG 615/B10x11	10x11	202	<b>10,50</b>
FG 615/B12x13	12x13	220	<b>11,20</b>
FG 615/B14x15	14x15	245	<b>12,60</b>
FG 615/B16x17	16x17	265	<b>14,20</b>
FG 615/B18x19	18x19	295	<b>16,80</b>
FG 615/B20x22	20x22	325	<b>18,90</b>

CODE	mm	L/mm	€/Pz
FG 615/B21x23	21x23	335	<b>21,50</b>
FG 615/B24x26	24x26	350	<b>24,10</b>
FG 615/B24x27	24x27	355	<b>25,70</b>
FG 615/B25x28	25x28	360	<b>27,80</b>
FG 615/B27x29	27x29	380	<b>29,50</b>
FG 615/B30x32	30x32	380	<b>31,50</b>
FG 615/B34x36	34x36	355	<b>61,00</b>
FG 615/B36x41	36x41	360	<b>68,00</b>
FG 615/B46x50	46x50	380	<b>128,00</b>

**Set of double combination wrenches**

CODE	Pz	CONTENT	€/Pz
FG 615/SC8	8	6x7, 8x9, 10x11, 12x13, 14x15, 16x17, 18x19, 20x22 mm	<b>105,00</b>
FG 615/SC13	13	6x7, 8x9, 10x11, 12x13, 14x15, 16x17, 18x19, 20x22, 21x23, 24x26, 25x28, 27x29, 30x32 mm	<b>239,00</b>





### Flare nut wrenches - DIN 3118

CODE	mm	L/mm	€/Pz
FG 180/A6x8	6x8	139	<b>12,60</b>
FG 180/A8x10	8x10	143	<b>13,60</b>
FG 180/A9x11	9x11	150	<b>14,90</b>
FG 180/A10x11	10x11	152	<b>14,90</b>
FG 180/A11x13	11x13	165	<b>16,30</b>
FG 180/A12x14	12x14	177	<b>18,40</b>
FG 180/A13x14	13x14	175	<b>20,50</b>
FG 180/B14x15	14x15	195	<b>20,50</b>

CODE	mm	A/mm	L/mm	€/Pz
FG 180/B14X17	14x17	29.9	195	<b>22,00</b>
FG 180/B17X19	17x19	32.9	210	<b>23,60</b>
FG 180/B19X22	19x22	38.4	232	<b>25,70</b>
FG 180/B22X24	22x24	41.3	250	<b>31,00</b>
FG 180/B24x27	24x27	45.6	260	<b>32,50</b>
FG 180/B30x32	30x32	50.6	280	<b>41,50</b>
FG 180/B36X41	36x41	57.9	345	<b>68,00</b>



### Flare nut wrenches inch version- DIN 3118

CODE	inch	L/mm	€/Pz
FG 180/IN1	1/4" x 5/16"	133	<b>11,30</b>
FG 180/IN2	5/16" x 3/8"	143	<b>12,00</b>
FG 180/IN3	3/8" x 7/16"	150	<b>13,00</b>
FG 180/IN4	1/2" x 9/16"	175	<b>16,00</b>
FG 180/IN5	5/8" x 11/16"	193	<b>17,00</b>
FG 180/IN6	3/4" x 7/8"	232	<b>25,00</b>
FG 180/IN7	7/8" x 1"	250	<b>28,50</b>



### Set of flare nut wrenches in nylon pouch

CODE	Pz	CONTENT	€/Pz
FG 180/SP6	6	8x10, 10x11, 11x13, 12x14, 17x19, 19x22	<b>122,00</b>
FG 180/SP9	9	8x10, 9x11, 10x11, 11x13, 12x14, 17x19, 19x22, 24x27, 30x32	<b>212,00</b>
FG 180/SP7IN	7	1/4"x5/16", 5/16"x3/8", 3/8"x7/16", 1/2"x9/16", 5/8"x11/16", 3/4"x7/8", 7/8"x1"	<b>133,00</b>

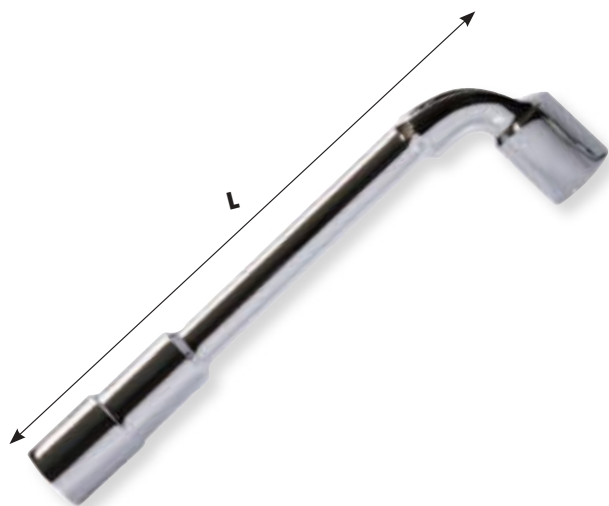

### Pipe wrenches 6PTx12PT - DIN 3118

CODE	mm	L/mm	€/Pz
FG 613/A6	6	113.0	<b>13,00</b>
FG 613/A7	7	122.0	<b>13,00</b>
FG 613/A8	8	126.0	<b>13,00</b>
FG 613/A9	9	131.0	<b>13,00</b>
FG 613/A10	10	140.0	<b>14,00</b>
FG 613/A11	11	150.0	<b>14,00</b>
FG 613/A12	12	155.0	<b>15,80</b>
FG 613/A13	13	165.0	<b>18,90</b>
FG 613/A14	14	180.0	<b>18,90</b>
FG 613/A15	15	193.0	<b>20,50</b>
FG 613/A16	16	204.0	<b>22,00</b>
FG 613/A17	17	209.0	<b>23,00</b>
FG 613/A18	18	225.0	<b>24,00</b>

CODE	mm	L/mm	€/Pz
FG 613/A19	19	230.0	<b>26,00</b>
FG 613/A20	20	235.0	<b>27,00</b>
FG 613/A21	21	249.0	<b>32,00</b>
FG 613/A22	22	266.0	<b>34,00</b>
FG 613/A23	23	268.0	<b>37,00</b>
FG 613/A24	24	288.0	<b>39,90</b>
FG 613/A25	25	297.0	<b>44,00</b>
FG 613/A26	26	311.0	<b>47,00</b>
FG 613/A27	27	315.0	<b>52,50</b>
FG 613/A28	28	332.0	<b>54,60</b>
FG 613/A30	30	362.0	<b>63,00</b>
FG 613/A32	32	385.0	<b>67,00</b>



### Set of pipe wrenches in carton box

CODE	Pz	CONTENT	€/Pz
FG 613/S9	9	8, 10, 11, 12, 13, 15, 17, 18, 19 mm	<b>175,00</b>
FG 613/S11	11	6, 7, 8, 10, 11, 12, 13, 14, 17, 19, 22mm	<b>205,00</b>
FG 613/S17	17	6, 7, 8, 9, 10, 11, 12, 13, 14, 15, 16, 17, 18, 19, 20, 21, 22mm	<b>345,00</b>

## Tube wrench, heavy duty model

CODE	mm	L/mm	€/Pz	CODE	mm	L/mm	€/Pz
FG 614/A6x7	6x7	106	<b>11,80</b>	FG 614/A20x22	20x22	175	<b>26,00</b>
FG 614/A8x9	8x9	108	<b>14,00</b>	FG 614/A21x23	21x23	186	<b>29,50</b>
FG 614/A10x11	10x11	122	<b>15,00</b>	FG 614/A24x26	24x26	195	<b>35,00</b>
FG 614/A12x13	12x13	138	<b>17,50</b>	FG 614/A25x28	25x28	207	<b>40,00</b>
FG 614/A14x15	14x15	148	<b>19,00</b>	FG 614/A27x29	27x29	209	<b>46,00</b>
FG 614/A16x17	16x17	157	<b>21,00</b>	FG 614/A30x32	30x32	209	<b>53,50</b>
FG 614/A18x19	18x19	165	<b>23,00</b>				

### Set of tube wrenches in carton box

CODE	Pz	CONTENT	€/Pz
FG 614A/S8	8	6x7,8x9,10x11,12x13,14x15,16x17,18x19,20x22	<b>150,00</b>
FG 614A/S13	13	6x7,8x9,10x11,12x13,14x15,16x17,18x19,20x22,21x23,24x26,25x28,27x29,30x32	<b>355,00</b>

### Pins for tube wrenches

CODE	mm	€/Pz
FG 614/AS1	6-13mm	<b>5,30</b>
FG 614/AS2	14-22mm	<b>7,00</b>
FG 614/AS3	21-32mm	<b>11,50</b>



## Tube wrench, light model

CODE	mm	L/mm	€/Pz	CODE	mm	L/mm	€/Pz
FG 614/B6x7	6x7	110	<b>5,30</b>	FG 614/B20x22	20x22	170	<b>14,70</b>
FG 614/B8x9	8x9	113	<b>5,30</b>	FG 614/B21x23	21x23	172	<b>15,80</b>
FG 614/B10x11	10x11	122	<b>6,50</b>	FG 614/B24x26	24x26	189	<b>17,90</b>
FG 614/B12x13	12x13	142	<b>7,70</b>	FG 614/B25x28	25x28	200	<b>20,50</b>
FG 614/B14x15	14x15	142	<b>8,20</b>	FG 614/B27x29	27x29	200	<b>23,00</b>
FG 614/B16x17	16x17	154	<b>8,70</b>	FG 614/B30x32	30x32	202	<b>26,00</b>
FG 614/B18x19	18x19	161	<b>11,60</b>				

### Set of tube wrenches in carton box

CODE	Pz	CONTENT	€/Pz
FG 614B/S8	8	6x7,8x9,10x11,12x13,14x15,16x17,18x19,20x22	<b>70,00</b>
FG 614B/S13	13	6x7,8x9,10x11,12x13,14x15,16x17,18x19,20x22,21x23,24x26,25x28,27x29,30x32	<b>175,00</b>



## T-handle wrenches

CODE	mm	A/mm	L1/mm	L/mm	€/Pz
FG 616/A8	8	10.0	160.0	220.0	<b>17,00</b>
FG 616/A10	10	12.0	160.0	230.0	<b>19,00</b>
FG 616/A12	12	15.0	175.0	242.0	<b>21,50</b>
FG 616/A13	13	18.0	175.0	246.0	<b>22,00</b>
FG 616/A14	14	19.0	190.0	252.0	<b>23,00</b>
FG 616/A17	17	23.0	220.0	267.0	<b>27,50</b>

### Set of T-Handle wrenches

CODE	Pz	CONTENT	€/Pz
FG 616A/S6	6	8, 10, 12, 13, 14, 17mm	<b>132,00</b>

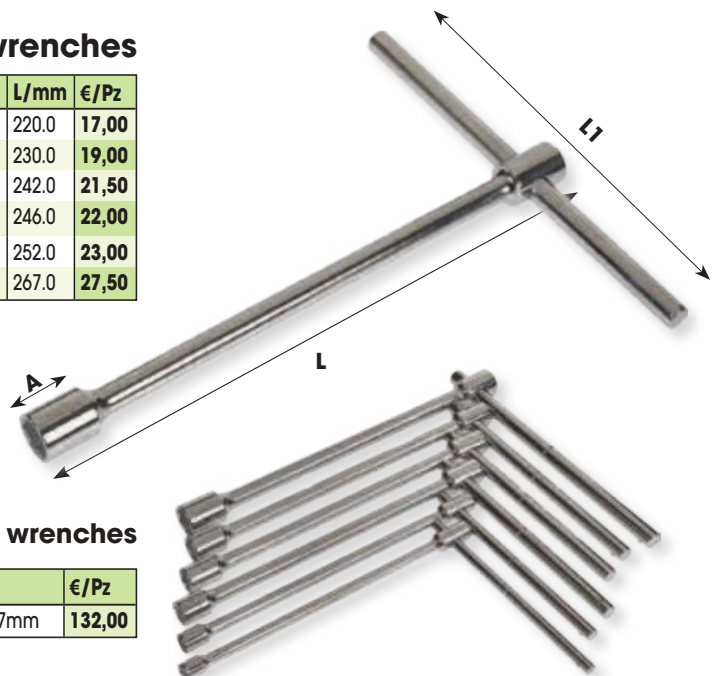

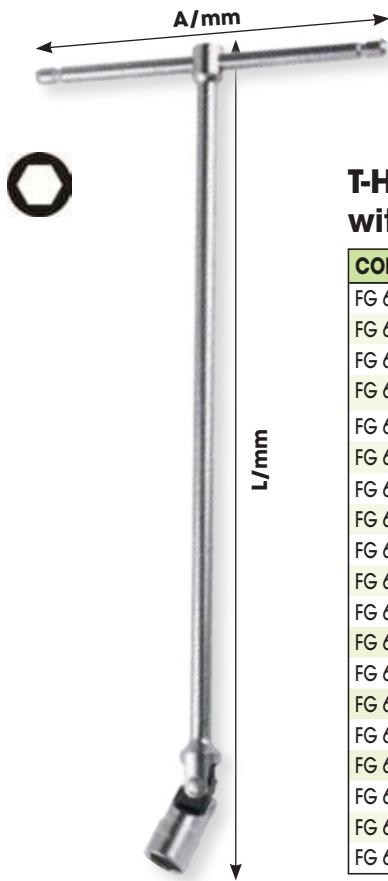

### T-Handle wrenches with swivel joint socket

CODE	mm	L/mm	A/mm	€/Pz
FG 618/A6	6	396	146	29,00
FG 618/A7	7	397	146	29,00
FG 618/A8	8	397	146	29,50
FG 618/A9	9	397	146	29,50
FG 618/A10	10	403	160	32,00
FG 618/A11	11	403	160	32,50
FG 618/A12	12	403	160	33,00
FG 618/A13	13	431	175	36,00
FG 618/A14	14	431	175	36,00
FG 618/A15	15	448	200	43,00
FG 618/A16	16	448	200	43,00
FG 618/A17	17	448	200	43,00
FG 618/A18	18	448	200	43,00
FG 618/A19	19	501	230	53,00
FG 618/A20	20	501	230	53,00
FG 618/A21	21	501	230	53,00
FG 618/A22	22	501	230	53,00
FG 618/A23	23	501	230	53,00
FG 618/A24	24	501	230	53,00

### REINFORCED JOINT



### Set of T-Handle wrenches with swivel joint socket

CODE	Pz	CONTENT	€/Pz
FG 618/S7B	7	7, 8, 10, 12, 13, 14, 17mm	245,00
FG 618/S7	7	8, 10, 11, 13, 14, 17, 19 mm	265,00
FG 618/S10	10	8, 10, 11, 12, 13, 14, 15, 16, 17, 19 mm	385,00
FG 618/S18	18	6,7,8,9,10,11,12,13,14,15,16,17,18, 19,20,21,22,24 mm	726,00

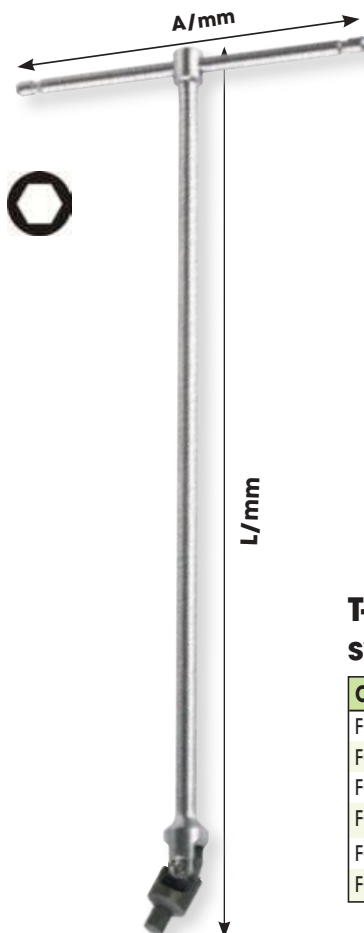

### T-Handle wrenches with swivel male hex ends

CODE	mm	L/mm	A/mm	€/Pz
FG 619/H3	3	399	146	32,50
FG 619/H4	4	399	146	32,50
FG 619/H5	5	399	146	32,50
FG 619/H6	6	430	175	39,50
FG 619/H8	8	430	175	41,00
FG 619/H10	10	430	175	46,00

### REINFORCED JOINT



### Set of T-Handle wrenches with swivel hex male ends

CODE	Pz	CONTENT	€/Pz
FG 619H/S5	5	3, 4, 5, 6, 8, mm	182,00
FG 619H/S6	6	3, 4, 5, 6, 8, 10 mm	227,00

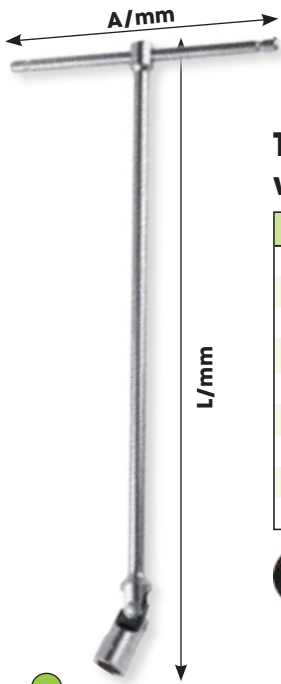

### T-Handle wrenches with swivel Torx socket

CODE	mm	L/mm	A/mm	€/Pz
FG 618/E6	E6	146.0	396.0	<b>34,00</b>
FG 618/E7	E7	146.0	396.0	<b>34,00</b>
FG 618/E8	E8	146.0	396.0	<b>38,00</b>
FG 618/E10	E10	146.0	396.0	<b>38,00</b>
FG 618/E12	E12	160.0	405.0	<b>45,00</b>
FG 618/E14	E14	160.0	405.0	<b>56,00</b>
FG 618/E16	E16	175.0	433.0	<b>56,00</b>
FG 618/E18	E18	200.0	449.0	<b>57,00</b>
FG 618/E20	E20	200.0	449.0	<b>57,00</b>



### Set of T-Handle wrenches with swivel joint socket

CODE	Pz	CONTENT	€/Pz
FG 618E/S9	9	E6, E7, E8, E9, E10, E12, E14, E16, E18, E20	<b>418,00</b>

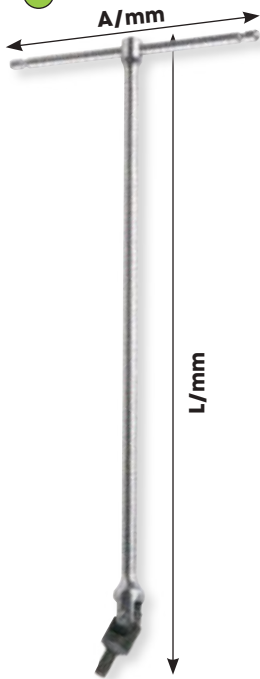

### T-Handle wrenches with swivel male Torx ends

CODE	mm	L/mm	A/mm	€/Pz
FG 619/TX20	TX20	399	146	<b>38,00</b>
FG 619/TX25	TX25	399	146	<b>38,00</b>
FG 619/TX27	TX27	399	146	<b>38,00</b>
FG 619/TX30	TX30	399	146	<b>38,00</b>
FG 619/TX40	TX40	412	160	<b>42,00</b>
FG 619/TX45	TX45	412	160	<b>44,00</b>
FG 619/TX50	TX50	437	175	<b>47,00</b>
FG 619/TX55	TX55	437	175	<b>51,00</b>



### Set of T-Handle wrenches with swivel Torx male ends

CODE	Pz	CONTENT	€/Pz
FG 619TX/S8	8	TX20, 25, 27, 30, 40, 45, 50, 55	<b>340,00</b>

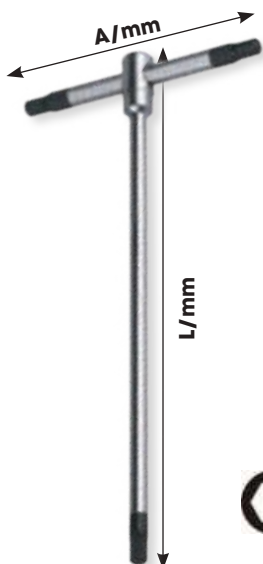

### T-Handle wrench with 3 hex male ends - sliding rod

CODE	mm	L/mm	A/mm	€/Pz
FG 621/H2	2	125.0	62.0	<b>14,30</b>
FG 621/H2,5	2,5	125.0	62.0	<b>14,30</b>
FG 621/H3	3	126.0	62.0	<b>14,30</b>
FG 621/H3,5	3,5	127.0	64.0	<b>14,30</b>
FG 621/H4	4	185.0	90.0	<b>15,60</b>
FG 621/H4,5	4,5	181.0	85.0	<b>16,80</b>
FG 621/H5	5	185.0	90.0	<b>18,50</b>
FG 621/H6	6	210.0	100.0	<b>21,50</b>
FG 621/H7	7	212.0	105.0	<b>21,50</b>
FG 621/H8	8	252.0	121.0	<b>22,00</b>
FG 621/H9	9	300.0	145.0	<b>25,00</b>
FG 621/H10	10	302.0	150.0	<b>27,80</b>
FG 621/H12	12	322.0	166.0	<b>29,50</b>
FG 621/H14	14	344.0	172.0	<b>38,00</b>



### Set of T-Handle wrenches with 3 hex male ends

CODE	Pz	CONTENT	€/Pz
FG 621H/S8	8	2,2.5,3,3.5,4,5,6,8mm	<b>139,00</b>
FG 621H/S8B	8	2,2.5,3,3.5,4,4.5,5,6mm	<b>132,00</b>
FG 621H/S8C	8	2,2.5,3,4,5,6,8,10mm	<b>152,00</b>
FG 621H/S14	14	2,2.5,3,3.5,4,4.5,5,6,7,8,9,10,12,14mm	<b>298,00</b>





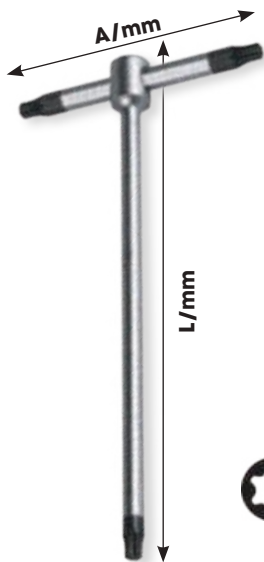

### T-Handle wrench with 3 Torx male ends

CODE	mm	L/mm	A/mm	€/Pz
FG 621/TX6	6	127.0	65.0	15,80
FG 621/TX7	7	127.0	65.0	15,80
FG 621/TX8	8	127.0	65.0	15,80
FG 621/TX9	9	125.0	65.0	15,80
FG 621/TX10	10	127.0	65.0	15,80
FG 621/TX15	15	127.0	65.0	15,80
FG 621/TX20	20	127.0	65.0	15,80
FG 621/TX25	25	185.0	90.0	16,80
FG 621/TX27	27	185.0	90.0	16,80
FG 621/TX30	30	185.0	90.0	16,80
FG 621/TX40	40	213.0	105.0	20,00
FG 621/TX45	45	212.0	107.0	23,00
FG 621/TX50	50	215.0	107.0	25,00



### Set of T-Handle wrenches with 3 Torx male ends

CODE	Pz	CONTENT	€/Pz
FG 621TX/S8B	8	10, 15, 20, 25, 27, 30, 40, 45 TX	145,00
FG 621TX/S13	13	6, 7, 8, 9, 10, 15, 20, 25, 27, 30, 40, 45, 50 TX	235,00

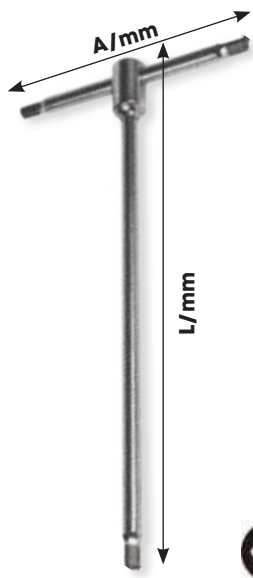

### T-Handle wrench with 3 hex male ends - fixed rod

CODE	mm	L/mm	A/mm	€/Pz
FG 622/H2	2	125.0	62.0	20,00
FG 622/H2,5	2,5	125.0	62.0	20,00
FG 622/H3	3	150.0	75.0	20,50
FG 622/H3,5	3,5	150.0	75.0	20,50
FG 622/H4	4	180.0	90.0	22,50
FG 622/H4,5	4,5	180.0	90.0	22,50
FG 622/H5	5	210.0	105.0	24,00
FG 622/H6	6	210.0	105.0	26,00
FG 622/H7	7	210.0	105.0	26,00
FG 622/H8	8	250.0	125.0	32,00
FG 622/H9	9	280.0	140.0	32,00
FG 622/H10	10	300.0	150.0	42,00
FG 622/H12	12	320.0	160.0	52,00
FG 622/H14	14	340.0	170.0	60,00



### Set of T-Handle wrenches with 3 hex male ends

CODE	Pz	CONTENT	€/Pz
FG 622H/S6	6	2.5, 3, 4, 5, 6, 8mm	155,00
FG 622H/S7	7	2.5, 3, 4, 5, 6, 8, 10mm	195,00

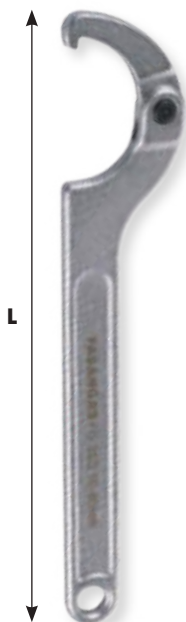

### Hook wrench with square noses for ring nuts

CODE	CAPACITY	A/mm	L/mm	€/Pz
FG 36/1	13 - 35 mm	4.96	168.0	27,00
FG 36/2	35 - 50mm	5.94	214.0	30,50
FG 36/3	50 - 80mm	7.65	280.0	42,00
FG 36/4	80 - 120mm	8.60	342.0	55,00
FG 36/5	120 - 180mm	10.75	480.0	74,00



### Hook wrench with square noses for ring nuts

CODE	CAPACITY	A/mm	L/mm	€/Pz
FG 38/1	16-18-20mm	2.0	108.0	8,60
FG 38/2	22-25-28mm	2.5	135.0	10,50
FG 38/3	30-32mm	2.5	135.0	10,50
FG 38/4	34-36-38mm	3.0	170.0	12,50
FG 38/5	40-42mm	3.0	170.0	12,50
FG 38/6	45-50mm	3.5	206.0	15,80
FG 38/7	52-55mm	3.5	206.0	15,70
FG 38/8	58-62-65mm	4.0	241.0	18,90
FG 38/9	68-70-75mm	4.0	241.0	18,90
FG 38/10	80-85-90mm	5.0	280.0	25,00
FG 38/11	92-95-100mm	5.0	280.0	25,00
FG 38/12	110-115mm	5.0	334.0	36,80
FG 38/13	120-130mm	5.0	334.0	42,00
FG 38/14	135-145mm	6.0	385.0	58,00
FG 38/15	155-165mm	6.0	385.0	58,00
FG 38/16	180-195mm	6.0	466.0	76,00



## Hook wrench with round noses for ring nuts



CODE	CAPACITY	A/mm	L/mm	€/Pz
FG 37/1	13 - 35 mm	2.74	168.0	<b>27,50</b>
FG 37/2	35 - 50mm	3.77	210.0	<b>33,50</b>
FG 37/3	50 - 80mm	4.77	280.0	<b>43,00</b>
FG 37/4	80 - 120mm	5.74	348.0	<b>59,00</b>
FG 37/5	120 - 180mm	7.76	495.0	<b>75,50</b>

### Round noses for FG 37

CODE	€/Pz
FG 37/1R	<b>5,50</b>
FG 37/2R	<b>6,50</b>

CODE	€/Pz
FG 37/3R	<b>9,00</b>
FG 37/4R	<b>12,00</b>
FG 37/5R	<b>14,50</b>

## Ring slogging wrenches - DIN 7444



CODE	mm	A/mm	L/mm	€/Pz
FG 604/A24	24	43.4	168	<b>23,50</b>
FG 604/A27	27	46.0	180	<b>27,00</b>
FG 604/A30	30	51.5	190	<b>33,50</b>
FG 604/A32	32	54.0	190	<b>34,50</b>
FG 604/A36	36	58.5	205	<b>50,00</b>
FG 604/A41	41	65.0	230	<b>57,00</b>
FG 604/A46	46	73.5	240	<b>69,00</b>
FG 604/A50	50	78.5	253	<b>82,00</b>
FG 604/A55	55	85.0	266	<b>93,00</b>
FG 604/A60	60	92.0	280	<b>112,00</b>
FG 604/A65	65	102.0	300	<b>138,00</b>
FG 604/A70	70	110.0	330	<b>165,00</b>
FG 604/A75	75	110.0	330	<b>178,00</b>

CODE	mm	A/mm	L/mm	€/Pz
FG 604/A80	80	118.0	340	<b>290,00</b>
FG 604/A85	85	130.0	355	<b>328,00</b>
FG 604/A90	90	142.0	390	<b>368,00</b>
FG 604/A95	95	142.0	390	<b>430,00</b>
FG 604/A100	100	155.0	420	<b>530,00</b>
FG 604/A105	105	155.0	420	<b>598,00</b>
FG 604/A110	110	168.0	450	<b>619,00</b>
FG 604/A115	115	168.0	450	<b>695,00</b>
FG 604/A120	120	182.0	480	<b>988,00</b>
FG 604/A125	125	182.0	480	<b>1.260,00</b>
FG 604/A130	130	194.0	510	<b>1.490,00</b>
FG 604/A135	135	194.0	510	<b>1.630,00</b>

## Open end slogging wrenches - DIN 3113

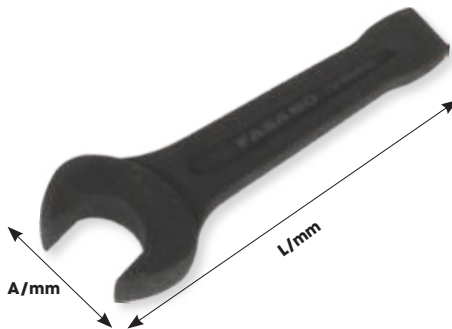

CODE	mm	A/mm	L/mm	€/Pz
FG 604/B24	24	56.0	180	<b>25,00</b>
FG 604/B27	27	56.0	180	<b>26,00</b>
FG 604/B30	30	62.0	190	<b>32,00</b>
FG 604/B32	32	62.0	190	<b>34,00</b>
FG 604/B36	36	76.0	215	<b>45,00</b>
FG 604/B41	41	86.0	235	<b>55,00</b>
FG 604/B46	46	98.0	255	<b>72,00</b>
FG 604/B50	50	105.0	275	<b>85,00</b>
FG 604/B55	55	116.0	300	<b>99,00</b>
FG 604/B60	60	128.0	320	<b>110,00</b>
FG 604/B65	65	138.0	342	<b>139,00</b>
FG 604/B70	70	154.0	375	<b>178,00</b>

CODE	mm	A/mm	L/mm	€/Pz
FG 604/B75	75	154.0	375	<b>195,00</b>
FG 604/B80	80	161.0	360	<b>290,00</b>
FG 604/B85	85	168.0	380	<b>320,00</b>
FG 604/B90	90	184.0	400	<b>365,00</b>
FG 604/B95	95	184.0	400	<b>376,00</b>
FG 604/B100	100	200.0	430	<b>522,00</b>
FG 604/B105	105	200.0	430	<b>590,00</b>
FG 604/B110	110	215.0	465	<b>645,00</b>
FG 604/B115	115	215.0	465	<b>740,00</b>
FG 604/B120	120	238.0	500	<b>770,00</b>
FG 604/B125	125	238.0	500	<b>875,00</b>

## Heavy duty offset ring wrenches

To be used with bars FG 624D/PR



CODE	mm	A/mm	L/mm	€/Pz
FG 604/D24	24	38.0	100	<b>46,00</b>
FG 604/D27	27	41.0	190	<b>48,00</b>
FG 604/D30	30	48.0	200	<b>52,00</b>
FG 604/D32	32	49.0	235	<b>59,00</b>
FG 604/D36	36	55.0	245	<b>65,00</b>
FG 604/D41	41	62.0	265	<b>82,00</b>
FG 604/D46	46	69.0	280	<b>90,00</b>
FG 604/D50	50	76.0	290	<b>107,00</b>
FG 604/D55	55	81.0	300	<b>118,00</b>

CODE	mm	A/mm	L/mm	€/Pz
FG 604/D60	60	90.0	345	<b>152,00</b>
FG 604/D65	65	95.0	355	<b>175,00</b>
FG 604/D70	70	105.0	365	<b>200,00</b>
FG 604/D75	75	110.0	375	<b>222,00</b>
FG 604/D80	80	125.0	385	<b>252,00</b>
FG 604/D85	85	125.0	385	<b>258,00</b>
FG 604/D90	90	140.0	410	<b>462,00</b>
FG 604/D95	95	140.0	410	<b>494,00</b>
FG 604/D100	100	143.0	412	<b>525,00</b>

### Extension bar for FG 624/D

CODE	L/mm	⬡/mm	€/Pz
FG 604D/PR1	460	24/30	<b>33,00</b>
FG 604D/PR2	580	32/41	<b>50,00</b>
FG 604D/PR3	760	46/55	<b>71,00</b>
FG 604D/PR4	860	60/100	<b>95,00</b>



## Reversible gear wrench

Equipped with integrated steel ring that allows the bolt to hold



Inversion lever flush with the head and with tongue inclined downwards for greater maneuvering space



CODE	mm	L/mm	€/Pz
FG 605/A6	6	128.0	15,30
FG 605/A7	7	140.0	15,30
FG 605/A8	8	140.0	15,30
FG 605/A9	9	149.0	16,30
FG 605/A10	10	158.0	16,80
FG 605/A11	11	165.0	17,30
FG 605/A12	12	171.0	17,90
FG 605/A13	13	178.0	18,40
FG 605/A14	14	190.0	19,40
FG 605/A15	15	199.0	20,50
FG 605/A16	16	208.0	22,60
FG 605/A17	15	225.0	22,60
FG 605/A18	18	236.0	24,70
FG 605/A19	15	247.0	24,70

### Set of reversible gear wrenches on ABS holder

CODE	Pz	CONTENT	€/Pz
FG 605/ST9-B	9	8,10,11,12,13,14,15,17,19mm	180,00
FG 605/ST11-B	11	8,9,10,11,12,13,14,15,16,17,19mm	220,00

## Reversible gear wrenches

CODE	mm	L/mm	€/Pz
FG 605/B6	6	134.0	12,20
FG 605/B7	7	158.0	12,20
FG 605/B8	8	134.0	12,60
FG 605/B9	9	158.0	12,60
FG 605/B10	10	158.0	12,60
FG 605/B11	11	164.0	13,10
FG 605/B12	12	167.0	13,90
FG 605/B13	13	177.0	14,60
FG 605/B14	14	189.8	15,20
FG 605/B15	15	198.0	16,30

CODE	mm	L/mm	€/Pz
FG 605/B16	16	204.0	17,30
FG 605/B17	17	224.0	19,10
FG 605/B18	18	235.4	20,00
FG 605/B19	19	246.9	21,00
FG 605/B21	21	280.0	30,00
FG 605/B22	22	280.0	30,00
FG 605/B24	24	310.0	36,00
FG 605/B27	27	330.0	48,00
FG 605/B30	30	425.0	68,00
FG 605/B32	32	425.0	70,00

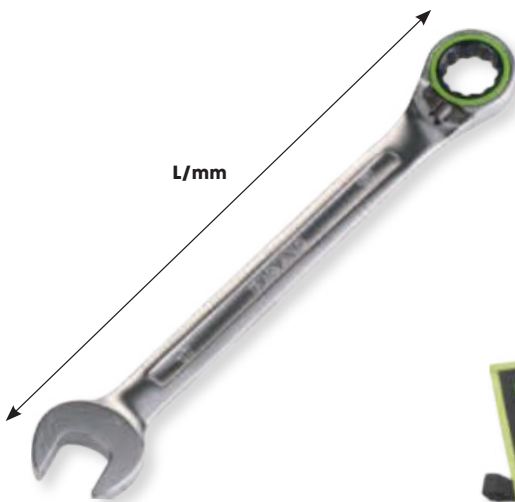

### Set of reversible gear wrenches in nylon box

CODE	Pz	CONTENT	€/Pz
FG 605/SP6	6	8,10,13,14,17,19 mm	105,00
FG 605/SP9	9	8,10,11,12,13,14,15,17,19 mm	150,00
FG 605/SP11	11	8,9,10,11,12,13,14,15,16,17,19 mm	182,00

### Set of reversible gear wrenches in carton box

CODE	Pz	CONTENT	€/Pz
FG 605/SC12	12	8,9,10,11,12,13,14,15,16,17,18,19 mm	188,30
FG 605/SC15	15	6,7,8,9,10,11,12,13,14,15,16,17,18,19,22 mm	245,00
FG 605/SC19	19	6,7,8,9,10,11,12,13,14,15,16,17,18,19,22,24,27,30,32 mm	465,00

## No-reversible gear wrenches

CODE	mm	L/mm	€/Pz
FG 606/B8	8	134.4	10,50
FG 606/B9	9	158.5	11,00
FG 606/B10	10	158.5	11,10
FG 606/B11	11	164.6	11,10
FG 606/B12	12	167.7	11,80
FG 606/B13	13	177.4	12,30
FG 606/B14	14	189.8	12,90

CODE	mm	L/mm	€/Pz
FG 606/B15	15	198.4	14,20
FG 606/B16	16	205.4	14,50
FG 606/B17	17	224.4	15,80
FG 606/B18	18	235.4	17,30
FG 606/B19	19	246.9	17,60



### Set of no-reversible gear wrenches in nylon box

CODE	Pz	CONTENT	€/Pz
FG 606/SP6	6	8,10,13,14,17,19 mm	90,00
FG 606/SP9	9	8,10,11,12,13,14,15,17,19 mm	128,00



### Gear wrenches with flexible head

CODE	mm	L/mm	€/Pz
FG 610/FL8	8	134	<b>18,50</b>
FG 610/FL9	9	158	<b>18,50</b>
FG 610/FL10	10	158	<b>19,50</b>
FG 610/FL11	11	164	<b>20,00</b>
FG 610/FL12	12	167	<b>21,00</b>
FG 610/FL13	13	177	<b>21,50</b>

CODE	mm	L/mm	€/Pz
FG 610/FL14	14	189	<b>23,50</b>
FG 610/FL15	15	198	<b>24,00</b>
FG 610/FL16	16	204	<b>25,50</b>
FG 610/FL17	17	224	<b>27,50</b>
FG 610/FL18	18	235	<b>28,50</b>
FG 610/FL19	19	245	<b>28,35</b>

### Set of flexible gear wrenches in nylon box

CODE	Pz	CONTENT	€/Pz
FG 610FL/SP6	6	8, 10, 13, 15, 17, 19 mm	<b>148,00</b>
FG 610FL/SP9	9	8, 10, 12, 13, 15, 16, 17, 18, 19 mm	<b>225,00</b>
FG 610FL/SP11	11	8, 10, 11, 12, 13, 14, 15, 16, 17, 18, 19 mm	<b>270,00</b>



### Set of 6pcs double universal gear wrenches - 90 teeth

CODE	Pz	CONTENT	€/Pz
FG 615A/S6	6	8x9, 10x11, 12x13, 14x15, 16x18, 17x19mm	<b>130,00</b>



### Form of 5pcs Universal aluminum gear wrenches

CODE	Pz	CONTENT	€/Pz
FG 617A/S7	7	8, 10, 12, 13, 14, 15, 17mm	<b>165,00</b>



### Set of Universal double gear wrenches - extra-long series

CODE	Pz	CONTENT	€/Pz
FG 622A/S6	6	8x9, 10x11, 12x13, 14x15, 16x18, 17x19 mm	<b>130,00</b>
FG 622A/S2	2	21x22, 24x27 mm	<b>80,00</b>





# 02

**SOCKET WRENCHES**



## 1/4"dr. HEXAGONAL SOCKET WRENCH

### → USE:

hexagonal bolts

### → FINISHING:

mirror

CODE	mm	A/mm	B/mm	D/mm	E/mm	€/Pz
FG 624/E4	4	6.8	11.6	25.3	8.4	3,30
FG 624/E5	5	7.9	12.0	25.4	9.0	3,30
FG 624/E6	6	9.5	12.0	25.4	11.6	3,30
FG 624/E7	7	10.5	12.0	25.4	11.6	3,30
FG 624/E8	8	12.0	12.0	25.5	11.0	3,30
FG 624/E9	9	12.9	12.9	25.5	10.6	3,30
FG 624/E10	10	14.4	14.4	25.5	12.0	3,30
FG 624/E11	11	15.6	15.6	25.5	11.7	3,30
FG 624/E12	12	16.7	16.7	25.3	11.6	3,30
FG 624/E13	13	17.7	17.7	25.5	11.6	3,30
FG 624/E14	14	17.7	17.7	25.5	11.6	3,50

### Set 11pcs 1/4"dr. hexagonal sockets wrenches

CODE	Pz	CONTENT	€/Pz
FG 624/S11	11	4, 5, 6, 7, 8, 9, 10, 11, 12, 13, 14 mm	42,00

### Set 11pcs 1/4"dr. hexagonal sockets wrenches and ratchet handle

CODE	Pz	CONTENT	€/Pz
FG 624/S12	12	4, 5, 6, 7, 8, 9, 10, 11, 12, 13, 14 mm FG 624/CR14	80,00

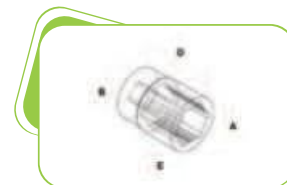

FG 624/E: 5, 6, 8, 10, 11, 13mm

FG 624/MCH14

1/4"x1/4"dr. ADAPTOR

FG 85/25PH1, PH2, PH3

FG 85/25PZ1, PZ2, PZ3

FG 85/25F3, F5

FG 85/25H4, H5, H6

FG 85/25TX10, TX15, TX20, TX25, TX30, TX40

### Set of 25pcs 1/4" of tools

CODE	Pz	€/Pz
FG 624/S25A	25	85,00



FG 624/E: 6, 8, 10, 11, 12, 13mm

FG 624/CR14

FG 89/38PI1 (1/4x1/4)

FG 85/25PH1, PH2, PH3

FG 85/25PZ1, PZ2, PZ3

FG 85/25F4, F5, F6, F7

FG 85/25TX10, TX15, TX20, TX25, TX30, TX40

### Set of 25pcs 1/4" of tools

CODE	Pz	€/Pz
FG 624/S25	18	90,00





**Set of 18pcs 1/4" of tools**

CODE	Pz	€/Pz
FG 624/S18	18	135,00

**FG 624/E4,5,6,7,8,9,10,11,12,13,14mm**

---

**FG 624/CR14**

---

**FG 624/ES14**  
**FG 624/PA50, 100**  
**FG 624/PRF150**

---

**FG 624/GR14C**

---

**FG 624/SN14**



**Set of 45pcs 1/4" of tools**

CODE	Pz	€/Pz
FG 624/S45	45	205,00

**FG 624/E4,5,6,7,8,9,10,11,12,13,14mm**

---

**FG 624/CR14**

---

**FG 624/ES14**  
**FG 624/PA50, 100**  
**FG 624/PRF150**

---

**FG 624/SN14**

---

**FG 624/GR14C**

---

**FG 148/H1.5-H10, FG 148/TX8-TX40**  
**FG 148/PH1-PH4, FG 148/F1-F5**

**Soft form of 18pcs 1/4"dr. tools**

CODE	Pz	€/Pz
FG 100/17	18	135,00



**FG 624/E4,5,6,7,8,9,10,11,12,13,14mm**

---

**FG 624/CR14**

---

**FG 624/SN14**

---

**FG 624/GR14C**

---

**FG 624/PA50, 100**  
**FG 624/PRF150**  
**FG 624/ES14**

**Soft form of 65pcs 1/4"dr. tools**

CODE	Pz	€/Pz
FG 102/17	18	125,00



**Plateaux souple de 65 outils de 1/4"**

CODE	Pz	€/Pz
FG 100/17E	65	285,00

**4,5,6,7,8,9,10,11,12,13,14mm**

---

**FG 624/CR14**

---

**FG 624/PA50, 100**  
**FG 624/PRF150**  
**FG 624/ES14**

---

**FG 624/SN14**

---

**FG 624/GR14C**

---

**FG 147/H2.5-H10**  
**FG 147/PH1-PH4**  
**FG 147/TX9-TX40**  
**FG 147/F1-F5**

---

**FG 139/L**

**Rigid form of 65pcs 1/4"dr. tools**

CODE	Pz	€/Pz
FG 102/17E	65	265,00





## 1/4"dr. HEXAGONAL SOCKET WRENCH deep series

→ USE

hexagonal bolts

→ FINISH

mirror

CODE	mm	A/mm	B/mm	D/mm	E/mm	€/Pz
FG 624E/L4	4	7.0	12.0	4.0	51.0	<b>7,00</b>
FG 624E/L5	5	8.0	12.0	9.0	51.0	<b>7,00</b>
FG 624E/L6	6	9.0	12.0	11.0	51.0	<b>7,00</b>
FG 624E/L7	7	11.0	12.0	21.0	51.0	<b>7,00</b>
FG 624E/L8	8	11.0	12.0	21.0	51.0	<b>7,50</b>
FG 624E/L9	9	13.0	12.0	21.0	51.0	<b>7,50</b>
FG 624E/L10	10	15.0	15.0	21.0	51.0	<b>7,50</b>
FG 624E/L11	11	15.1	15.0	21.0	51.0	<b>7,50</b>
FG 624E/L12	12	16.8	15.6	21.0	51.0	<b>7,50</b>
FG 624E/L13	13	16.8	15.6	21.0	51.0	<b>7,50</b>
FG 624E/L14	14	19.8	17.7	21.0	51.0	<b>7,50</b>

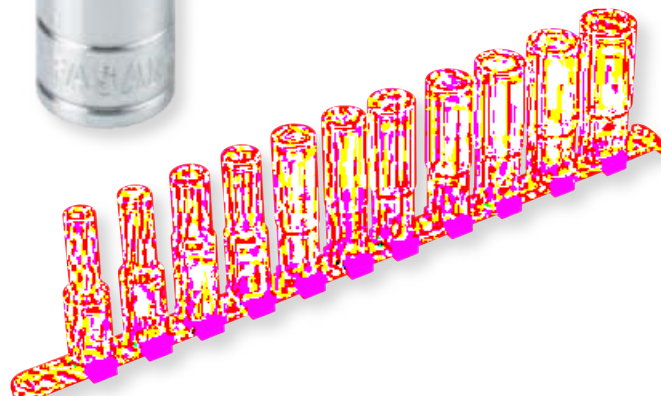

### Set of 11 pcs 1/4"dr. hexagonal sockets wrenches

CODE	Pz	CONTENT	€/Pz
FG 624L/S11	11	4, 5, 6, 7, 8, 9, 10, 11, 12, 13, 14 mm	<b>95,00</b>



### Set of 29 pcs 1/4"dr tools

CODE	Pz	€/Pz
FG 624/S29	29	<b>210,00</b>



4,5,6,7,8,9,10,  
11,12,13,14mm

FG 624/CR14

FG 624/PA50, 100

FG 624/PRF150

FG 624/ES14

FG 624/SN14

FG 624/GR14C

## 1/4"dr. HEXAGONAL SOCKET WRENCH

CODE	Pollici	A/mm	B/mm	D/mm	E/mm	€/Pz
FG 624A/IN1	5/32	6.8	11.6	25.3	8.4	<b>3,60</b>
FG 624A/IN2	3/16	7.7	12.0	25.4	10.7	<b>3,60</b>
FG 624A/IN3	7/32	8.7	12.0	25.4	10.9	<b>3,60</b>
FG 624A/IN4	1/4	9.5	12.0	25.4	11.6	<b>3,60</b>
FG 624A/IN5	9/32	10.5	12.0	25.4	11.6	<b>3,60</b>
FG 624A/IN6	5/16	12.0	12.0	25.5	11.0	<b>3,60</b>
FG 624A/IN7	11/32	12.9	12.9	25.5	10.6	<b>3,60</b>
FG 624A/IN8	3/8	14.4	14.4	25.5	12.0	<b>3,60</b>
FG 624A/IN9	7/16	15.6	15.6	25.5	11.7	<b>3,60</b>
FG 624A/IN10	15/32	16.7	16.7	25.3	11.6	<b>3,60</b>
FG 624A/IN11	1/2	17.7	17.7	25.5	11.6	<b>3,60</b>
FG 624A/IN12	9/16	17.7	17.7	25.5	11.6	<b>3,60</b>

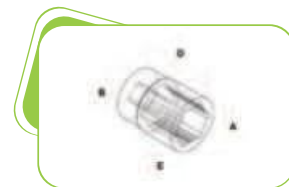

### Set of 12 pcs 1/4"dr. INCH hexagonal sockets wrenches

CODE	Pz	CONTENT	€/Pz
FG 624A/INS12	12	5/32, 3/16, 7/32, 1/4, 9/32, 5/16, 11/32, 3/8, 7/16, 15/32, 1/2, 9/16	<b>55,00</b>

## 1/4"dr. UNIVERSAL SOCKET WRENCH

### → USE

Hexagonal bolts, TORX,  
XZN, 12points and Square bolts

### → FINISH

mirror

CODE	mm	E	□	B/mm	C/mm	€/Pz
FG 624/U4	4	E5		7.0	9.5	<b>3,60</b>
FG 624/U4.5	4.5			7.5	9.5	<b>3,60</b>
FG 624/U5	5	E6		8.0	9.5	<b>3,60</b>
FG 624/U5.5	5.5			8.8	10.0	<b>3,60</b>
FG 624/U6	6	E8		9.6	10.0	<b>3,60</b>
FG 624/U7	7			10.6	10.0	<b>3,60</b>
FG 624/U8	8	E10		11.6	10.0	<b>4,00</b>
FG 624/U9	9			13.4	11.5	<b>4,00</b>
FG 624/U10	10	E12	8	14.0	11.5	<b>4,00</b>
FG 624/U11	11	E14		15.8	11.5	<b>4,00</b>
FG 624/U12	12	E16	10	16.9	11.5	<b>4,00</b>
FG 624/U13	13	E18	11	18.0	11.5	<b>4,00</b>
FG 624/U14	14		12	20.0	11.5	<b>4,10</b>

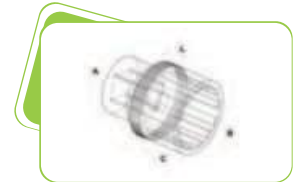

### Set of 13pcs 1/4"dr. UNIVERSAL socket wrenches

CODE	Pz	CONTENT	€/Pz
FG 624U/S13	13	4, 4.5, 5, 5.5, 6, 7, 8, 9, 10, 11, 12, 13, 14mm	<b>62,00</b>

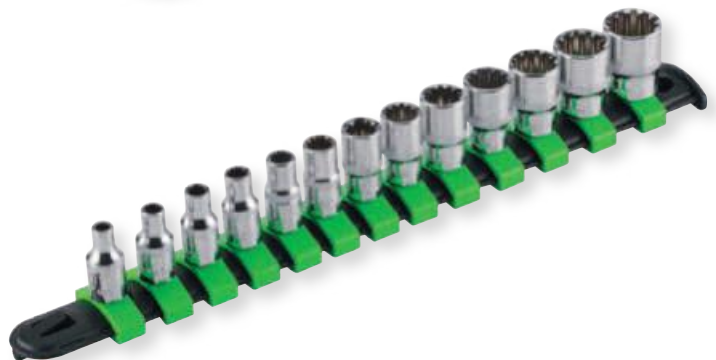

## 1/4"dr. TORX SOCKET WRENCH

### → USE

Torx bolts

### → FINISH

mirror

CODE	E	A/mm	B/mm	L/mm	€/Pz
FG 624/TX4	4	11.8	6.8	25.0	<b>5,50</b>
FG 624/TX5	5	11.8	8.0	25.0	<b>5,50</b>
FG 624/TX6	6	11.8	9.3	25.0	<b>5,50</b>
FG 624/TX7	7	11.8	10.6	25.0	<b>5,50</b>
FG 624/TX8	8	11.8	11.8	25.0	<b>5,50</b>
FG 624/TX10	10	11.8	11.8	25.0	<b>5,50</b>



### Set of 6pcs 1/4"dr. Torx sockets

CODE	Pz	CONTENT	€/Pz
FG 624TX/S6	6	4, 5, 6, 7, 8, 10 E	<b>45,00</b>



### Set of 6pcs 1/4" Torx sockets + 8pcs 1/4"dr Torx socket bits + accessories

CODE	CONTENT	€/Pz
FG 624TX/S17	BUSSOLE TX4, TX5, TX6, TX7, TX8, TX10	<b>76,00</b>
	INSERTI A BUSSOLA TX9, TX10, TX15, TX20, TX25, TX27, TX30, TX40	
	PROLUNGA 1/4" - 100mm	
	SNODO 1/4" + QUADRO MASCHIO 1/4"	





### 1/4"dr. Torx socket bit



CODE	TX	L/mm	€/Pz
FG 147/TX9	9	36.0	8,00
FG 147/TX10	10	36.0	8,00
FG 147/TX15	15	36.0	8,00
FG 147/TX20	20	36.0	8,00

CODE	TX	L/mm	€/Pz
FG 147/TX25	25	36.0	8,00
FG 147/TX27	27	36.0	8,00
FG 147/TX30	30	36.0	8,00
FG 147/TX40	40	36.0	8,00

### Set 8pcs 1/4"dr. TORX socket bits

CODE	Pz	CONTENT	€/Pz
FG 147TX/S8	8	TX9, 10, 15, 20, 25, 27, 30, 40	70,00

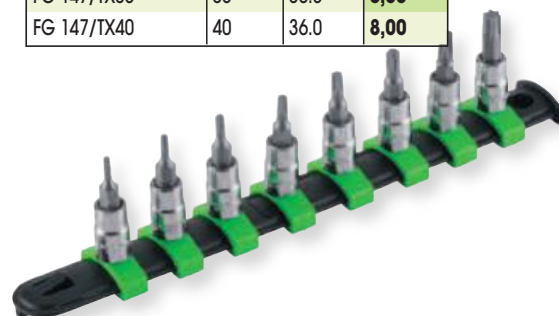

### 1/4"dr. socket bit for 5-star head screws



CODE	PH	L/mm	€/Pz
FG 147/PT10	10	36.0	9,20
FG 147/PT15	15	36.0	9,20
FG 147/PT20	20	36.0	9,20

CODE	PH	L/mm	€/Pz
FG 147/PT25	25	36.0	9,20
FG 147/PT27	30	36.0	9,20
FG 147/PT30	25	36.0	9,20

### Set of 6pcs 1/4"dr. socket bits for 5 star head screws

CODE	Pz	CONTENT	€/Pz
FG 147PT/S6	6	PT10, 15, 20, 25, 27, 30	63,00

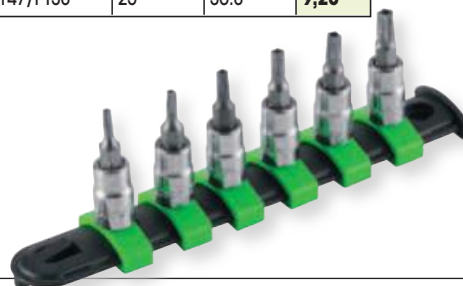

### 1/4"dr. hex socket bit



CODE	mm	L/mm	€/Pz
FG 147/H2.5	2.5	36.0	6,00
FG 147/H3	3	36.0	6,00
FG 147/H4	4	36.0	6,00
FG 147/H5	5	36.0	6,00

CODE	mm	L/mm	€/Pz
FG 147/H6	6	36.0	6,00
FG 147/H7	7	36.0	6,00
FG 147/H8	8	36.0	6,00
FG 147/H10	10	36.0	6,00

### Set of 8pcs 1/4"dr. socket bits for hex screws

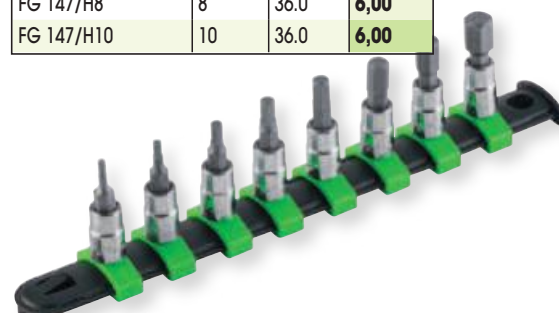

### 1/4"dr. Phillips socket bit



CODE	PH	L/mm	€/Pz
FG 147/PH1	1	36.0	6,00
FG 147/PH2	2	36.0	6,00
FG 147/PH3	3	36.0	6,00
FG 147/PH4	4	36.0	6,00



### 1/4"dr. slotted socket bit



CODE	mm	L/mm	€/Pz
FG 147/SL4	0.8X4.0	36.0	6,00
FG 147/SL5.5	1.0x5.5	36.0	6,00
FG 147/SL6.5	1.2x6.5	36.0	6,00
FG 147/SL8	1.6x8.0	36.0	6,00
FG 147/SL10	1.6x10.0	36.0	6,00



### 1/4"dr. Reversible ratchet handle

CODE	□	€/Pz
FG 624/CR14	1/4"	40,00

- Ring-shaped inversion system integrated on the head
- 72 tooth mechanism
- Mirror finish
- Hook-in slot

### Cricchetto reversibile 1/4" con impugnatura rotante - 60 denti

CODE	□	€/Pz
FG 624/RT14	1/4"	63,00



### Cricchetto reversibile 1/4" a 72 denti

CODE	□	€/Pz
FG 624/FR14	1/4"	42,00



### 1/4"dr. stubby ratchet

CODE	□	€/Pz
FG 624/MCR	1/4"	36,00



### 1/4"dr. stubby ratchet for bits

CODE	□	€/Pz
FG 624/MCH	1/4"	36,00



### 1/4"dr. Swivel drive with handle

CODE	L/mm	€/Pz
FG 624/CS14	160	26,00



- Model with closed dust-proof head
- Integrated reversing lever flush with the head
- 13 ° hollow body to allow use even in particularly difficult spaces
- 72 tooth mechanism
- Mirror finish
- Hook-in slot



### 1/4"dr. female and male drive wobble extension bar

CODE	L/mm	€/Pz
FG 624/PA50	50	8,00
FG 624/PA100	100	8,50

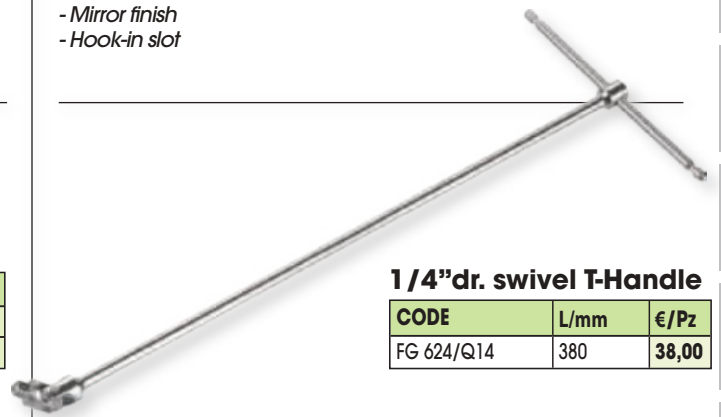

### 1/4"dr. swivel T-Handle

CODE	L/mm	€/Pz
FG 624/Q14	380	38,00



### 1/4"dr. female and male drive extension bar

CODE	L/mm	€/Pz
FG 624/PR50	50	6,80
FG 624/PR100	100	7,50
FG 624/PR150	150	8,20



### 1/4" sliding bar

CODE	L/mm	€/Pz
FG 624/ES14	115	7,00



### 1/4"dr. female and male drive extension bar - flexible

CODE	L/mm	€/Pz
FG 624/PRF150	150	12,00



CODE		L/mm	€/Pz
FG 624/GR14B	Asta flessibile	291.6	16,00
FG 624/GR14C	Asta NO flex	246.6	10,50



### 1/4" universal joint

CODE	L/mm	€/Pz
FG 624/SN14	38	15,00



## 3/8"dr. HEXAGONAL SOCKET WRENCH

- USE

hexagonal bolts

- FINISH

mirror

CODE	mm	A/mm	B/mm	D/mm	E/mm	€/Pz
FG 624/B8	8	12.2	20.0	32.0	5.0	5,60
FG 624/B9	9	13.5	20.0	32.0	5.0	5,60
FG 624/B10	10	14.7	20.0	32.0	6.0	5,60
FG 624/B11	11	16.0	20.0	32.0	7.0	5,60
FG 624/B12	12	17.2	20.0	32.0	8.0	5,60
FG 624/B13	13	18.5	20.0	32.0	8.0	5,60
FG 624/B14	14	19.8	20.0	32.0	10.0	5,80
FG 624/B15	15	21.0	21.0	35.0	10.0	5,80
FG 624/B16	16	22.2	23.0	35.0	10.0	6,00
FG 624/B17	17	23.8	24.0	35.0	10.0	6,00
FG 624/B18	18	24.8	24.0	35.0	12.0	6,00
FG 624/B19	19	26.0	24.0	35.0	12.0	7,00
FG 624/B21	21	28.5	27.0	35.0	12.0	7,00
FG 624/B22	22	29.7	28.0	38.0	14.0	7,00
FG 624/B23	23	31.5	28.8	38.0	14.0	7,00

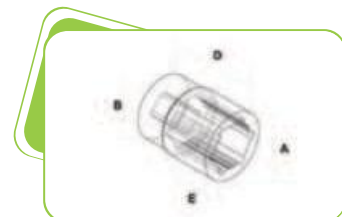

## Set of 15pcs 3/8"dr. hex sockets

CODE	Pz	CONTENT	€/Pz
FG 624B/S15	15	8, 9, 10, 11, 12, 13, 14, 15, 16, 17, 18, 19, 21, 22, 23mm	115,00

Set of 15pcs 3/8"dr. hex sockets  
+ 3/8"dr. ratchet handle

CODE	Pz	CONTENT	€/Pz
FG 624B/S16	16	8, 9, 10, 11, 12, 13, 14, 15, 16, 17, 18, 19, 21, 22, 23mm FG 624/CR38	152,00

Set of 22pcs  
3/8"dr. tools

CODE	Pz	€/Pz
FG 624B/S22	22	230,00



FG 624/B8,9,10,11,12,13,14,15  
16,17,18,19,21,22,23mm

FG 624/CR38

FG 624B/PA75,125,150,250

FG 624/ES38

FG 624/SN38

Soft form 22pcs  
3/8"dr. tools

CODE	Pz	€/Pz
FG 100/19	22	220,00

Rigid form 22pcs  
3/8"dr. tools

CODE	Pz	€/Pz
FG 102/19	22	200,00



FG 624/B8,9,10,11,12,13,14,15  
16,17,18,19,21,22,23mm

FG 624/CR38

FG 624B/PA75,100,125,250

FG 624/ES38

FG 624/SN38

## 3/8"dr. HEXAGONAL SOCKET WRENCH -deep series

### → USE

hexagonal bolts

### → FINISH

mirror



CODE	mm	A/mm	B/mm	D/mm	E/mm	€/Pz
FG 624B/L8	8	12.2	17.5	7.1	54.0	<b>10,20</b>
FG 624B/L9	9	13.2	17.5	7.1	54.0	<b>10,20</b>
FG 624B/L10	10	14.8	17.5	7.9	54.0	<b>10,20</b>
FG 624B/L11	11	16.2	17.5	9.7	54.0	<b>10,20</b>
FG 624B/L12	12	17.5	17.5	9.9	54.0	<b>10,20</b>
FG 624B/L13	13	17.8	17.8	10.7	54.0	<b>10,20</b>
FG 624B/L14	14	19.8	18.6	10.7	61.0	<b>10,20</b>
FG 624B/L15	15	20.3	19.5	10.7	61.0	<b>11,50</b>
FG 624B/L16	16	21.8	20.2	10.7	61.0	<b>11,50</b>
FG 624B/L17	17	23.8	21.8	11.2	67.0	<b>11,50</b>
FG 624B/L18	18	24.8	23.5	11.2	67.0	<b>11,50</b>
FG 624B/L19	19	25.8	24.0	12.2	67.9	<b>11,50</b>
FG 624B/L21	21	27.8	26.4	12.4	67.0	<b>13,50</b>
FG 624B/L22	22	29.8	27.2	13.0	73.0	<b>13,50</b>
FG 624B/L23	23	31.5	28.8	13.2	73.0	<b>13,50</b>

### Set of 15pcs 3/8"dr. hex sockets

CODE	Pz	CONTENT	€/Pz
FG 624L/S15	15	8, 9, 10, 11, 12, 13, 14, 15, 16, 17, 18, 19, 21, 22, 23mm	<b>180,00</b>

### Set of 15pcs 3/8"dr. hex sockets + 3/8"dr. ratchet handle

CODE	Pz	CONTENT	€/Pz
FG 624L/S16	16	8, 9, 10, 11, 12, 13, 14, 15, 16, 17, 18, 19, 21, 22, 23mm FG 624/CR38	<b>220,00</b>

### Set of 20pcs 3/8"dr. tools

CODE	Pz	€/Pz
FG 624B/LS20	20	<b>310,00</b>



### Soft form 20pcs 3/8"dr. tools

CODE	Pz	€/Pz
FG 100/18	20	<b>295,00</b>

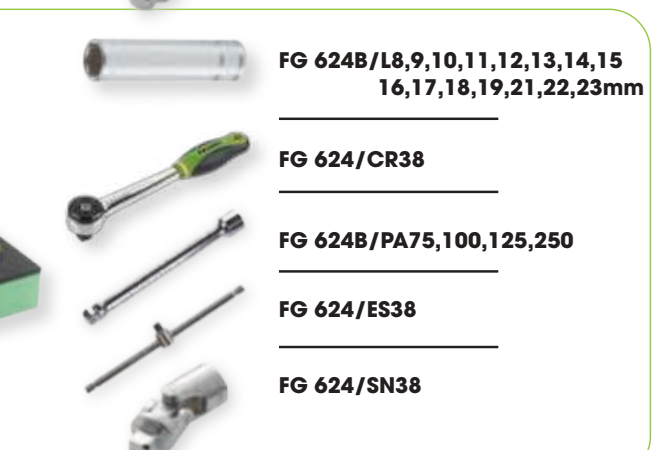
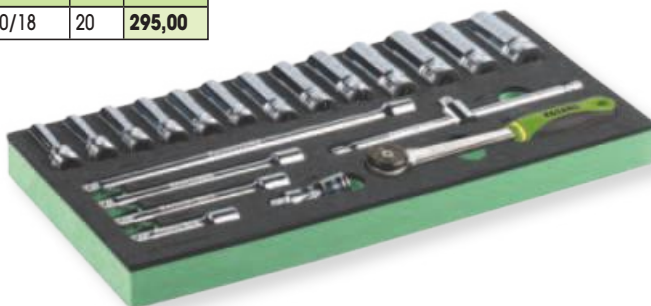

## 3/8"dr 12PT SOCKET WRENCH

→ USE

Hex and 12PT bolts

→ FINISH

mirror

CODE	mm	A/mm	B/mm	D/mm	E/mm	€/Pz
FG 624/C6	6	12.2	20.0	32.0	5.0	4,50
FG 624/C7	7	13.5	20.0	32.0	5.0	4,50
FG 624/C8	8	12.2	20.0	32.0	5.0	4,70
FG 624/C9	9	13.5	20.0	32.0	5.0	4,70
FG 624/C10	10	14.7	20.0	32.0	6.0	4,70
FG 624/C11	11	16.0	20.0	32.0	7.0	4,70
FG 624/C12	12	17.2	20.0	32.0	8.0	4,70
FG 624/C13	13	18.5	20.0	32.0	8.0	4,70
FG 624/C14	14	19.8	20.0	32.0	10.0	4,80
FG 624/C15	15	21.0	21.0	35.0	10.0	4,90
FG 624/C16	16	22.2	23.0	35.0	10.0	4,90
FG 624/C17	17	23.8	24.0	35.0	10.0	5,00
FG 624/C18	18	24.8	24.0	35.0	12.0	5,20
FG 624/C19	19	26.0	24.0	35.0	12.0	5,20
FG 624/C20	20	26.0	24.0	35.0	12.0	5,20
FG 624/C21	21	28.5	27.0	35.0	12.0	5,60
FG 624/C22	22	29.7	28.0	38.0	14.0	5,60
FG 624/C24	24	31.5	28.8	38.0	14.0	6,20

### Set of 18pcs 12PT socket wrenches on metal rail

CODE	Pz	CONTENT	€/Pz
FG 624C/S18	18	6, 7, 8, 9, 10, 11, 12, 13, 14, 15, 16, 17, 18, 19, 20, 21, 22, 24mm	105,00



### Set of 22pcs 3/8"dr. tools

CODE	Pz	€/Pz
FG 624C/S22	22	210,00



FG 624/C8,9,10,11,12,13,14,  
15,16,17,18,19, 21mm

FG 624/CR38

FG 624B/PA75,125,150,250

FG 624/ES38

FG 624/SN38

### Soft form of 22pcs 3/8"dr. tools

CODE	Pz	€/Pz
FG 100/19B	22	200,00

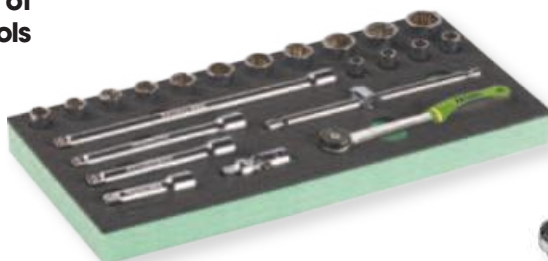

### Plastic tray of 22pcs 3/8"dr. tools

CODE	Pz	€/Pz
FG 102/19B	22	180,00



FG 624/C8,9,10,11,12,13,14,  
15,16,17,18,19,21mm

FG 624/CR38

FG 624B/PA75,100,125,250

FG 624/ES38

FG 624/SN38

## 3/8"dr 12PT SOCKET WRENCH -série longue

**- USE**

Hex and 12PT bolts

**- FINISH**

mirror

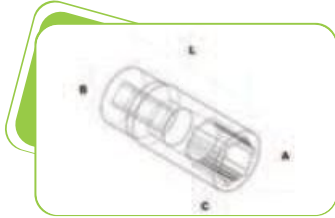

CODE	mm	A/mm	B/mm	D/mm	E/mm	€/Pz
FG 624/L6	6	12.2	17.5	7.1	54.0	8,00
FG 624/L7	7	13.2	17.5	7.1	54.0	8,00
FG 624/L8	8	12.2	17.5	7.1	54.0	8,00
FG 624/L9	9	13.2	17.5	7.1	54.0	8,00
FG 624/L10	10	14.8	17.5	7.9	54.0	8,00
FG 624/L11	11	16.2	17.5	9.7	54.0	8,00
FG 624/L12	12	17.5	17.5	9.9	54.0	8,00
FG 624/L13	13	17.8	17.8	10.7	54.0	8,20
FG 624/L14	14	19.8	18.6	10.7	61.0	8,80
FG 624/L15	15	20.3	19.5	10.7	61.0	10,30
FG 624/L16	16	21.8	20.2	10.7	61.0	10,30
FG 624/L17	17	23.8	21.8	11.2	67.0	11,00
FG 624/L18	18	24.8	23.5	11.2	67.0	11,50
FG 624/L19	19	25.8	24.0	12.2	67.9	11,50
FG 624/L20	20	26.0	26.4	12.4	67.0	12,00
FG 624/L21	21	27.8	26.4	12.4	67.0	12,00
FG 624/L22	22	29.8	27.2	13.0	73.0	12,50
FG 624/L24	24	31.5	28.8	13.2	73.0	13,00

**Set of 18pcs 12PT socket wrenches**

CODE	Pz	CONTENT	€/Pz
FG 624L/S18	18	6, 7, 8, 9, 10, 11, 12, 13, 14, 15, 16, 17 18, 19, 20, 21, 22, 24mm	198,00



**Set of 20pcs 3/8"dr. tools**

CODE	Pz	€/Pz
FG 624L/S20	20	270,00

**FG 624/L8,9,10,11,12,13,14, 15, 16,17,18,19,21mm**

**FG 624/CR38**

**FG 624B/PA75,125,150,250**

**FG 624/ES38**

**FG 624/SN38**

**Soft form of 20pcs 3/8"dr. tools**

CODE	Pz	€/Pz
FG 100/18B	20	250,00

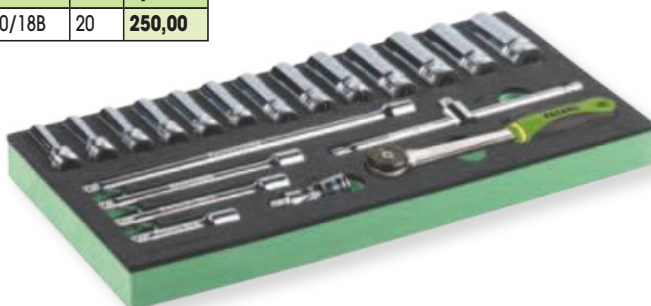

**FG 624/L8,9,10,11,12,13,14, 15, 16,17,18,19,21mm**

**FG 624/CR38**

**FG 624B/PA75,100,125,250**

**FG 624/ES38**

**FG 624/SN38**





## 3/8"dr 12PT INCH SOCKET WRENCH

→ USE

Inch bolts

→ FINISH

mirror

CODE	"	A/mm	B/mm	D/mm	E/mm	€/Pz
FG 624C/IN1	1/4	12.2	20.0	32.0	5.0	5,50
FG 624C/IN2	5/16	12.2	20.0	32.0	5.0	5,50
FG 624C/IN3	11/32	13.5	20.0	32.0	5.0	5,50
FG 624C/IN4	3/8	14.7	20.0	32.0	6.0	5,50
FG 624C/IN5	7/16	16.0	20.0	32.0	7.0	5,50
FG 624C/IN6	15/32	17.2	20.0	32.0	8.0	6,00
FG 624C/IN7	1/2	18.5	20.0	32.0	8.0	6,00
FG 624C/IN8	9/16	19.8	20.0	32.0	10.0	6,00
FG 624C/IN9	19/32	21.0	21.0	35.0	10.0	6,50
FG 624C/IN10	5/8	22.2	23.0	35.0	10.0	6,50
FG 624C/IN11	11/16	23.8	24.0	35.0	10.0	6,50
FG 624C/IN12	3/4	26.0	24.0	35.0	12.0	7,00
FG 624C/IN13	25/32	26.0	24.0	35.0	12.0	7,00
FG 624C/IN14	13/16	28.5	27.0	35.0	12.0	7,50
FG 624C/IN15	7/8	29.7	28.0	38.0	14.0	8,20
FG 624C/IN16	15/16	31.5	28.8	38.0	14.0	8,60

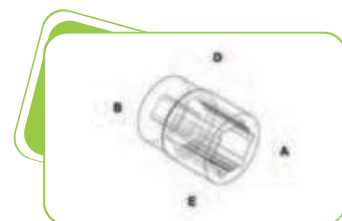

### Set of 13pcs 12PT inch socket wrenches

CODE	Pz	CONTENT	€/Pz
FG 624C/INS13	13	1/4, 5/16, 11/32, 3/8, 7/16, 1/2, 9/16, 19/32, 5/8, 11/16, 3/4, 13/16, 7/8	90,00



### Set of 23pcs 3/8"dr. tools

CODE	Pz	€/Pz
FG 624C/INS23	23	230,00



1/4, 5/16, 11/32, 3/8, 7/16, 15/32, 1/2, 9/16, 19/32, 5/8, 11/16, 3/4, 25/32, 13/16, 7/8, 15/16

FG 624/CR38

FG 624B/PA75,150,125,250

FG 624/ES38

FG 624/SN38

### Soft form of 23pcs 3/8"dr. tools

CODE	Pz	€/Pz
FG 100/19IN	23	220,00

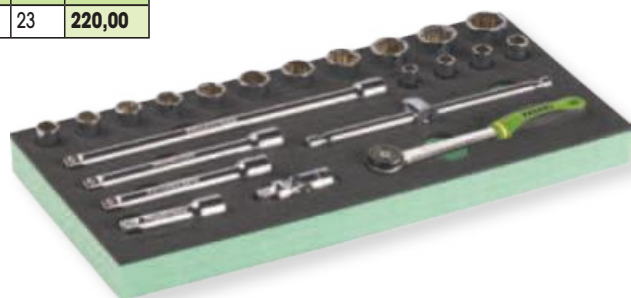

1/4, 5/16, 11/32, 3/8, 7/16, 15/32, 1/2, 9/16, 19/32, 5/8, 11/16, 3/4, 25/32, 13/16, 7/8, 15/16

FG 624/CR38

FG 624B/PA75,150,125,250

FG 624/ES38

FG 624/SN38

## 3/8"dr TORX SOCKET WRENCH

**- USE**  
Torx bolts

**- FINISH**  
mirror

CODE	mm	A/mm	B/mm	E/mm	L/mm	€/Pz
FG 624B/TX5	5	16.8	9.3	10.5	28.0	<b>6,50</b>
FG 624B/TX6	6	16.8	9.3	10.5	28.0	<b>6,50</b>
FG 624B/TX7	7	16.9	11.7	10.7	28.0	<b>6,50</b>
FG 624B/TX8	8	16.9	11.7	10.7	28.0	<b>6,50</b>
FG 624B/TX10	10	16.9	14.5	10.8	28.0	<b>6,50</b>
FG 624B/TX12	12	19.8	17.0	14.0	32.0	<b>6,50</b>
FG 624B/TX14	14	19.8	17.5	14.0	32.0	<b>6,50</b>
FG 624B/TX16	16	19.8	17.0	14.0	32.0	<b>6,50</b>

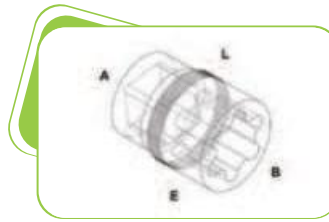

**Set of 8pcs Torx socket wrenches**

CODE	Pz	CONTENT	€/Pz
FG 624TX/S8	8	5, 6, 7, 8, 10, 12, 14, 16 E	<b>60,00</b>

## 3/8"dr TORX SOCKET WRENCH deep series

**- USE**  
Torx bolts

**- FINISH**  
mirror

CODE	mm	A/mm	B/mm	L/mm	€/Pz
FG 624L/TX6	6	16.8	10.0	63.0	<b>10,50</b>
FG 624L/TX7	7	16.8	10.9	63.0	<b>10,50</b>
FG 624L/TX8	8	16.8	12.0	63.0	<b>10,50</b>
FG 624L/TX10	10	16.8	14.9	63.0	<b>10,50</b>
FG 624L/TX12	12	16.8	15.8	63.0	<b>10,50</b>
FG 624L/TX14	14	16.8	16.8	63.0	<b>10,50</b>
FG 624L/TX16	16	17.8	17.8	63.0	<b>10,50</b>
FG 624L/TX18	18	17.8	19.8	63.0	<b>10,50</b>



**Set of 8pcs Torx socket wrenches**

CODE	Pz	CONTENT	€/Pz
FG 624L/TXS8	8	6, 7, 8, 10, 12, 14, 16, 18 E	<b>92,00</b>

## Set 10 3/8"dr. TORX socket wrenches - EXTRA LONG series

**- Content:**  
E6, E7, E8, E10, E11, E12, E14, E16, E18, E20

CODE	Pz	€/Pz
FG 624B/TXS10	10	<b>135,00</b>





## 3/8"dr. Torx socket bits

CODE	TX	L/mm	€/Pz
FG 149/TX9	9	50.0	10,50
FG 149/TX10	10	50.0	10,50
FG 149/TX15	15	50.0	10,50
FG 149/TX20	20	50.0	10,50

CODE	TX	L/mm	€/Pz
FG 149/TX25	25	50.0	10,50
FG 149/TX27	27	50.0	10,50
FG 149/TX30	30	50.0	10,50
FG 149/TX40	40	50.0	10,50



## Set of 8pcs 3/8"dr. Torx socket bits

CODE	Pz	CONTENT	€/Pz
FG 149TX/S8	8	TX9, 10, 15, 20, 25, 27, 30, 40	90,00

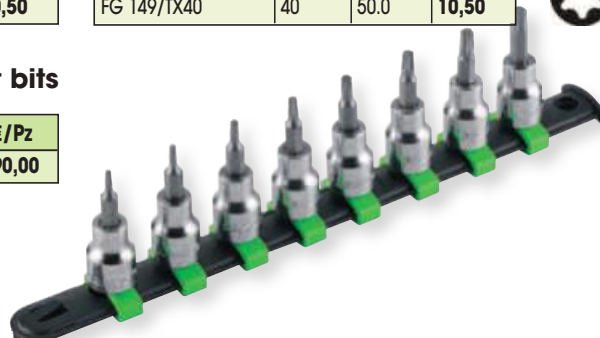

## Set of 8pcs 3/8"dr. Torx socket bits

CODE	Pz	CONTENT	€/Pz
FG 149TX/S8B	8	TX9, 10, 15, 20, 25, 27, 30, 40	95,00



## 3/8"dr. hexagonal socket bits

CODE	mm	L/mm	€/Pz
FG 149/H3	3	50.0	6,60
FG 149/H4	4	50.0	6,60
FG 149/H5	5	50.0	6,60
FG 149/H6	6	50.0	6,60

CODE	mm	L/mm	€/Pz
FG 149/H7	7	50.0	6,60
FG 149/H8	8	50.0	6,60
FG 149/H10	10	50.0	6,60



## Set of 7pcs 3/8"dr. hexagonal socket bits

CODE	Pz	CONTENT	€/Pz
FG 149H/S7	7	3,4,5,6,7,8,10	52,00

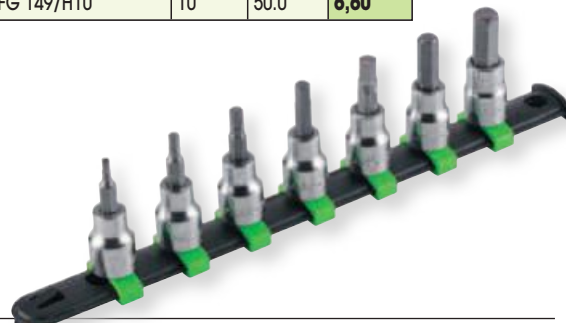

## 3/8"dr. socket bits for 5-star head screws

CODE	PT	L/mm	€/Pz
FG 149/PT40	40	50.0	9,50
FG 149/PT45	45	50.0	9,50
FG 149/PT50	50	50.0	9,50



## 3/8"dr. slotted socket bits

CODE	mm	L/mm	€/Pz
FG 149/SL5.5	1.0x5.5	50.0	6,60
FG 149/SL6.5	1.2x6.5	50.0	6,60
FG 149/SL8	1.6x8.0	50.0	6,60
FG 149/SL10	1.6x10.0	50.0	6,60



## 3/8"dr. Phillips socket bits

CODE	PH	L/mm	€/Pz
FG 149/PH1	1	50.0	6,50
FG 149/PH2	2	50.0	6,50
FG 149/PH3	3	50.0	6,50
FG 149/PH4	4	50.0	6,50



## Set 8pcs 3/8" socket bits

CODE	Pz	€/Pz
FG 149PF/S8	8	56,00





### 3/8"dr. Reversible ratchet handle

CODE	□	€/Pz
FG 624/CR38	3/8"	42,00

- Ring-shaped inversion system integrated on the head
- 72 tooth mechanism
- Mirror finish
- Hook-in slot



### 3/8"dr. swivel drive with handle

CODE	L/mm	€/Pz
FG 624/CS38	260	33,00

### Mango macho articulado con cuadrado de 3/8"

CODE	L/mm	€/Pz
FG 624/Q38	425	42,00



### 3/8"dr. Universal joint

CODE	L/mm	€/Pz
FG 624/SN38	52	14,00

### 3/8"dr. swivel T-Handle

CODE	L/mm	€/Pz
FG 624/ES38	220	13,00

### 3/8" female and male drive wobble extension bar

CODE	L/mm	€/Pz
FG 624B/PA75	75	10,00
FG 624B/PA125	125	11,00
FG 624B/PA150	150	14,50
FG 624B/PA250	250	19,50

### Set of 80pcs tools with 3/8" drive

CODE	CONTENT	€/Pz
FG 624B/S80	80pz	250,00



FG 624/B8,9,10,11,12,13,14, 15,16,17,18,19,21,22,23



FG 624B/L8,10,13,17,19



FG 624/CR38



FG 625/SN38



FG 149/H3,4,5,6,7,8, 10  
FG 149/TX9,10,15,20,25,27,30,40



FG 624/ES38



FG 624B/PA75,125,150,250



FG 600/B8,10,13,15,17,19



FG 89/50PI2 3/8"x1/4"



FG 85/25PH1, PH2, PH3, FG 85/25PZ1, PZ2, PZ3  
FG 85/25SL3, SL4, SL4.5, SL5, SL5.5, SL6, L6.5  
FG 85/H1.5, H2, 2.5, H3, H4, H5, H6  
FG 85/25T9, T10, T15, T20, T25, T27, T30, T40  
FG 88/60PI2



## 1/2"dr. HEXAGONAL SOCKET WRENCH

## → USE

hexagonal bolts

## → FINISHING

mirros

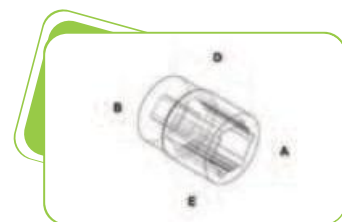

CODE	mm	A/mm	B/mm	D/mm	E/mm	€/Pz
FG 625/A8	8	14.9	21.8	38.1	7.5	5,00
FG 625/A9	9	16.5	21.8	38.1	8.0	5,00
FG 625/A10	10	14.9	21.8	38.1	7.5	5,00
FG 625/A11	11	16.5	21.8	38.1	8.0	5,00
FG 625/A12	12	18.2	21.8	38.1	9.1	5,00
FG 625/A13	13	19.0	21.8	38.1	9.1	5,00
FG 625/A14	14	20.5	21.8	38.1	10.7	5,00
FG 625/A15	15	22.2	22.6	38.1	10.7	5,00
FG 625/A16	16	23.8	22.6	38.1	10.7	5,00
FG 625/A17	17	24.5	22.9	38.1	12.7	5,00
FG 625/A18	18	25.4	23.7	38.1	13.9	6,00
FG 625/A19	19	26.3	24.8	38.1	14.0	6,00
FG 625/A20	20	27.1	26.1	38.1	14.0	6,50

CODE	mm	A/mm	B/mm	D/mm	E/mm	€/Pz
FG 625/A21	21	28.3	27.5	38.1	14.0	6,50
FG 625/A22	22	29.9	28.6	38.1	14.2	8,00
FG 625/A23	23	31.2	29.9	38.1	14.5	8,70
FG 625/A24	24	32.5	31.0	38.1	15.5	8,70
FG 625/A25	25	33.3	32.6	38.1	15.5	8,80
FG 625/A26	26	34.6	33.4	41.3	16.0	8,90
FG 625/A27	27	36.5	34.9	44.5	19.6	8,90
FG 625/A30	30	41.0	39.6	44.5	19.6	9,10
FG 625/A32	32	42.5	41.2	47.6	19.6	9,50

## Set of 1/2"dr. hexagonal socket wrenches

CODE	Pz	CONTENT	€/Pz
FG 625A/S11	11	8,10,11,12,13,14,15,16,17,18,19	78,00
FG 625A/S10	10	20,21,22,23,24,25,26,27,30,32	98,00

## Set 11pcs 1/2"dr. hexagonal sockets wrenches and ratchet handle

CODE	Pz	CONTENT	€/Pz
FG 625A/S12	12	8,10,11,12,13,14,15,16,17,18,19 + FG 625/CR12	130,00



## Set of 25pcs 1/2"dr. tools

CODE	Pz	€/Pz
FG 625A/S25	25	270,00



FG 625/A10,11,12,13,14,15,16,17,18, 19,20,21,22, 23,24,25,26,27,30,32mm

FG 625/CR12

FG 625/PA125, 250

FG 625/ES12

FG 625/SN12



## Soft form of 25pcs 1/2"dr. tools

CODE	Pz	€/Pz
FG 100/21B	25	240,00

## Plastic tray of 25pcs 1/2"dr. tools

CODE	Pz	€/Pz
FG 102/21B	25	230,00



FG 625/A10,11,12,13,14,15,16,17,18, 19,20,21,22, 23,24,25,26,27,30,32mm

FG 625/CR12

FG 625/PA125, 250

FG 625/ES12

FG 625/SN12



# 1/2"dr HEX SOCKET WRENCH -deep series

**- USE**

hexagonal bolts

**- FINISHING**

mirror

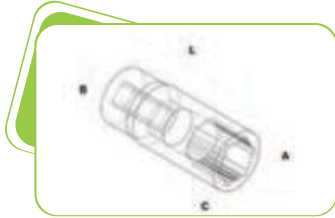

**Set of 37pcs  
1/2"dr. tools**

CODE	Pz	€/Pz
FG 625A/S37	37	475,00



**FG 625/A8, 9, 10,11,12,13,  
14,15,16,17, 18,19,20,21,22,23,  
24,26, 27,30,32mm**



**FG 625L/A10,12,13,14,17,19,21,  
22,24,27,30mm**



**FG 625/CR12**



**FG 625/PA125, 250**



**FG 625/ES12**



**FG 625/SN12**

CODE	mm	A/mm	B/mm	C/mm	L/mm	€/Pz
FG 625L/A10	10	15.4	22,0	20,0	76.8	12,80
FG 625L/A11	11	16.4	22,0	18,0	77,0	12,80
FG 625L/A12	12	18,0	22,0	20,0	76.8	12,80
FG625L/A13	13	19,0	22,0	19.4	77,0	12,80
FG 625L/A14	14	20.4	22,0	32.7	77,0	12,80
FG 625L/A15	15	21.9	20.9	34,0	76.3	12,80
FG 625L/A16	16	22,0	20.3	31.8	76.7	13,20
FG 625L/A17	17	24,0	22,0	31.5	77,0	13,20
FG 625L/A18	18	26,0	23,0	35.8	77.4	13,20
FG 625L/A19	19	26,0	24,0	31,0	77,0	13,20
FG 625L/A20	20	27.7	26.5	23,0	79.7	14,50
FG 625L/A21	21	27.8	26,0	31.7	77,0	14,50
FG 625L/A22	22	29.8	26,0	33,0	77,0	16,20
FG 625L/A23	23	31.5	28.8	23.6	72.9	18,20
FG 625L/A24	24	31.8	28,0	33,0	77,0	19,00
FG 625L/A25	25	33.2	31.7	23.4	80.2	19,00
FG 625L/A26	26	35,0	33.2	24,0	80.2	19,00
FG 625L/A27	27	35.8	31,0	31.5	77.1	22,00
FG 625L/A28	28	37.5	35.6	24,0	80.2	25,00
FG 625L/A29	29	37.8	34,0	31.4	77,0	25,00
FG 625L/A30	30	39.7	34,0	31.7	77,0	26,00
FG 625L/A32	32	43,0	40.9	27.3	80,0	26,00
FG 625L/A36	36	48,0	40,0	35,0	78,0	44,00

**Set of 1/2"dr. hex socket wrenches**

CODE	Pz	CONTENT	€/Pz
FG 625AL/S11	11	10,12,13,14,15,16,17,18,19,21,22mm	160,00
FG 625AL/S9	9	23,24,25,26,27,28,29,30,32	210,00

**Soft form of 37pcs  
1/2"dr. tools**

CODE	Pz	€/Pz
FG 100/21H	37	430,00



**FG 625/A8, 9, 10,11,12,13,  
14,15,16,17, 18,19,20,21,22,23,  
24,26, 27,30,32mm**



**FG 625L/A10,12,13,14,17,19,21,  
22,24,27,30mm**



**FG 625/CR12**



**FG 625/PA125, 250**



**FG 625/ES12**



**FG 625/SN12**



## 1/2"dr. 12PT SOCKET WRENCH

## → USE

hex and 12PT bolts

## → FINISHING

mirror

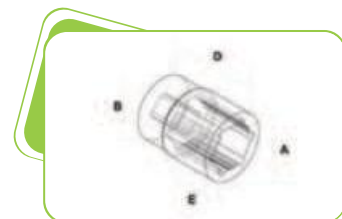

CODE	mm	C/mm	B/mm	D/mm	E/mm	€/Pz
FG 625/C8	8	14.9	21.8	38.1	7.5	5,00
FG 625/C9	9	16.5	21.8	38.1	8.0	5,00
FG 625/C10	10	14.9	21.8	38.1	7.5	5,00
FG 625/C11	11	16.5	21.8	38.1	8.0	5,00
FG 625/C12	12	18.2	21.8	38.1	9.1	5,00
FG 625/C13	13	19.0	21.8	38.1	9.1	5,00
FG 625/C14	14	20.5	21.8	38.1	10.7	5,00
FG 625/C15	15	22.2	22.6	38.1	10.7	5,00
FG 625/C16	16	23.8	22.6	38.1	10.7	5,00
FG 625/C17	17	24.5	22.9	38.1	12.7	5,00
FG 625/C18	18	25.4	23.7	38.1	13.9	6,00
FG 625/C19	19	26.3	24.8	38.1	14.0	6,00
FG 625/C20	20	27.1	26.1	38.1	14.0	6,50

CODE	mm	A/mm	B/mm	D/mm	E/mm	€/Pz
FG 625/C21	21	28.3	27.5	38.1	14.0	6,50
FG 625/C22	22	29.9	28.6	38.1	14.2	8,00
FG 625/C23	23	31.2	29.9	38.1	14.5	8,70
FG 625/C24	24	32.5	31.0	38.1	15.5	8,70
FG 625/C25	25	33.3	32.6	38.1	15.5	8,80
FG 625/C26	26	34.6	33.4	41.3	16.0	8,90
FG 625/C27	27	36.5	34.9	44.5	19.6	8,90
FG 625/C28	28	41.0	39.6	44.5	19.6	8,90
FG 625/C29	29	42.5	41.2	47.6	19.6	8,90
FG 625/C30	30	41.0	39.6	44.5	19.6	9,10
FG 625/C32	32	42.5	41.2	47.6	19.6	9,50

## Set of 1/2"dr. 12PT socket wrenches

CODE	Pz	CONTENT	€/Pz
FG 625/S11	11	8,10,11,12,13,14,15,16,17,18,19	75,00
FG 625/S12B	12	20,21,22,23,24,25,26,27,28,29,30,32	92,00

## Set 11pcs 1/2"dr. 12PT sockets wrenches and ratchet handle

CODE	Pz	CONTENT	€/Pz
FG 625/S12	12	8,10,11,12,13,14,15,16,17,18,19 + FG 625/CR12	120,00



## Set of 25pcs 1/2"dr. tools

CODE	Pz	€/Pz
FG 625C/S25	25	256,00

FG 625/C10,11,12,13,14,15,16,17,18, 19,20,21,22, 23,24,25,26,27,30,32mm

FG 625/CR12

FG 625/PA125, 250

FG 625/ES12

FG 625/SN12



## Soft form of 25pcs 1/2"dr. tools

CODE	Pz	€/Pz
FG 100/21C	25	240,00

## Plastic tray of 25pcs 1/2"dr. tools

CODE	Pz	€/Pz
FG 102/21C	25	230,00



FG 625/C10,11,12,13,14,15,16,17,18, 19,20,21,22, 23,24,25,26,27,30,32mm

FG 625/CR12

FG 625/PA125, 250

FG 625/ES12

FG 625/SN12



# 1/2"dr. 12PT SOCKET WRENCH - deep series

**- USE** hex and 12PT bolts  
**- FINISHING** mirror



CODE	mm	A/mm	B/mm	C/mm	L/mm	€/Pz
FG 625/L8	8	13,0	21,9	16,7	77,0	<b>10,00</b>
FG 625/L9	9	14,0	21,9	17,0	77,0	<b>10,00</b>
FG 625/L10	10	15,5	21,9	19,5	77,0	<b>10,00</b>
FG 625/L11	11	16,5	21,9	17,6	77,0	<b>10,00</b>
FG 625/L12	12	17,7	21,9	19,0	77,0	<b>10,00</b>
FG 625/L13	13	19,0	21,9	19,0	77,0	<b>10,00</b>
FG 625/L14	14	20,4	21,9	33,0	77,0	<b>10,00</b>
FG 625/L15	15	21,9	20,5	31,5	77,0	<b>10,00</b>
FG 625/L16	16	22,0	20,5	31,7	77,0	<b>10,00</b>
FG 625/L17	17	23,9	22,0	32,0	77,0	<b>10,00</b>
FG 625/L18	18	26,0	23,0	31,0	77,0	<b>10,20</b>
FG 625/L19	19	26,0	24,0	35,6	77,0	<b>10,20</b>
FG 625/L20	20	27,7	25,7	31,6	77,0	<b>11,80</b>
FG 625/L21	21	27,6	26,0	35,5	77,0	<b>13,00</b>
FG 625/L22	22	29,7	26,0	32,0	77,0	<b>14,50</b>
FG 625/L23	23	31,8	27,7	31,0	77,0	<b>14,50</b>
FG 625/L24	24	31,8	28,0	32,4	77,0	<b>14,50</b>
FG 625/L25	25	33,8	29,7	31,6	77,0	<b>16,50</b>
FG 625/L27	27	35,8	30,7	31,3	77,0	<b>19,00</b>
FG 625/L30	30	39,8	33,8	31,3	77,0	<b>24,50</b>
FG 625/L32	32	42,0	35,0	31,6	77,0	<b>25,50</b>
FG 625/L36	36	48,0	40,0	35,0	77,5	<b>44,00</b>

## Set of 1/2"dr. 12PT socket wrenches

CODE	Pz	CONTENT	€/Pz
FG 625L/S12	12	8,9,10,11,12,13,14,15,16,17,18,19mm	<b>110,00</b>
FG 625L/S6	6	21,22,24,27,30,32mm	<b>105,00</b>

## Set of 37pcs 1/2"dr. tools

CODE	Pz	€/Pz
FG 625/S37	37	<b>465,00</b>



**FG 625/C8, 9, 10,11,12,13, 14,15,16,17, 18,19,20,21,22,23, 24,26, 27,30,32mm**

**FG 625/L10,12,13,14,17,19,21, 22,24,27,30mm**

**FG 625/CR12**

**FG 625/PA125, 250**

**FG 625/ES12**

**FG 625/SN12**

## Soft form of 37pcs 1/2"dr. tools

CODE	Pz	€/Pz
FG 100/21L	37	<b>430,00</b>



**FG 625/C8, 9, 10,11,12,13, 14,15,16,17, 18,19,20,21,22,23, 24,26, 27,30,32mm**

**FG 625/L10,12,13,14,17,19,21, 22,24,27,30mm**

**FG 625/CR12**

**FG 625/PA125, 250**

**FG 625/ES12**

**FG 625/SN12**





## 1/2"dr. 12PT INCH SOCKET WRENCH

### → USE

hex and 12PT  
inch bolts

### → FINISHING

mirror

CODE	"	A/mm	B/mm	D/mm	E/mm	€/Pz
FG 625C/IN1	5/16	14.9	21.8	38.1	7.5	5,50
FG 625C/IN2	3/8	14.9	21.8	38.1	7.5	5,50
FG 625C/IN3	7/16	16.5	21.8	38.1	8.0	5,50
FG 625C/IN4	15/32	18.2	21.8	38.1	9.1	5,50
FG 625C/IN5	1/2	19.0	21.8	38.1	10.7	5,50
FG 625C/IN6	9/16	20.5	21.8	38.1	10.7	5,50
FG 625C/IN7	19/32	22.2	22.6	38.1	10.7	5,50
FG 625C/IN8	5/8	23.8	22.6	38.1	12.7	5,50
FG 625C/IN9	11/16	24.5	22.9	38.1	12.7	5,50
FG 625C/IN10	3/4	26.3	24.8	38.1	14.0	6,50
FG 625C/IN11	25/32	27.1	26.12	38.21	14.0	7,00
FG 625C/IN12	13/16	28.3	27.5	38.1	14.0	7,20
FG 625C/IN13	7/8	29.9	28.6	38.1	14.2	8,70

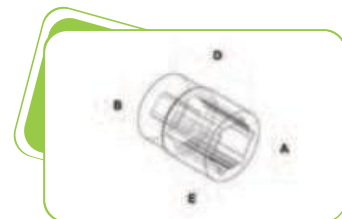

CODE	"	A/mm	B/mm	D/mm	E/mm	€/Pz
FG 625C/IN14	15/16	32.5	31.0	38.1	15.5	9,50
FG 625C/IN15	1	33.3	32.6	38.1	15.5	9,80
FG 625C/IN16	1.1/16	36.5	34.9	44.5	19.6	11,20
FG 625C/IN17	1.1/8	36.5	34.9	44.5	19.6	11,20
FG 625C/IN18	1.3/16	41.0	39.6	44.5	19.6	11,50
FG 625C/IN19	1.1/4	42.5	41.2	47.6	19.6	11,50

### Set of 11pcs 1/2"dr. 12PT inch sockets

CODE	Pz	CONTENT	€/Pz
FG 625IN/S11	11	3/8, 7/16, 1/2, 9/16, 5/8, 11/16, 3/4, 13/16, 7/8, 15/16, 1"	75,00



### Set of 24pcs 1/2"dr. tools

CODE	Pz	€/Pz
FG 625IN/S24	24	270,00



### Soft form of 24pcs 1/2"dr. tools

CODE	Pz	€/Pz
FG 100/21IN	24	260,00

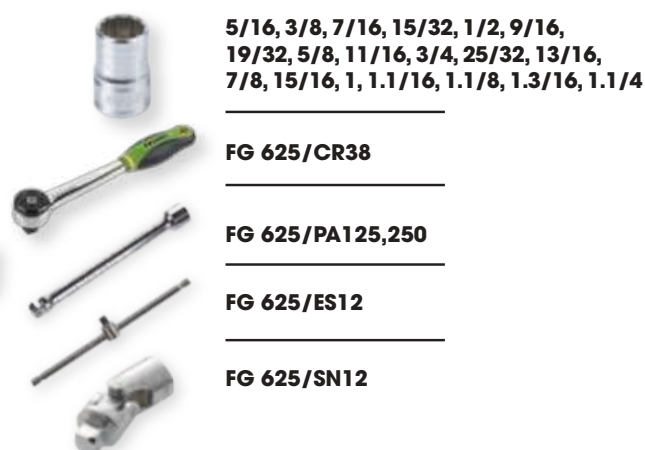

# 1/2"dr. UNIVERSAL SOCKET WRENCH

## - USE

Hexagonal bolts (intact and rounded off until **50%**), TORX, XZN, 12points and Square bolts

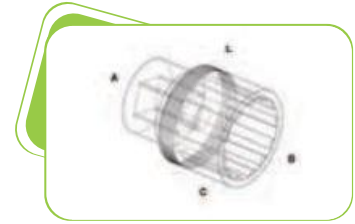

CODE	mm	E	□	B/mm	C/mm	L/mm	€/Pz
FG 626/A8	8	E10		13.5	21.9	38.1	<b>7,00</b>
FG 626/A10	10	E12	8	15.6	21.9	38.1	<b>7,00</b>
FG 626/A11	11	E14		16.7	21.9	38.1	<b>7,00</b>
FG 626/A12	12	E16	10	18.0	21.9	38.1	<b>7,00</b>
FG 626/A13	13	E18	11	19.1	21.9	38.1	<b>7,00</b>
FG 626/A14	14		12	20.8	22.0	38.1	<b>7,00</b>
FG 626/A15	15			23.0	22.0	38.1	<b>7,00</b>
FG 626/A16	16	E20		24.0	22.0	38.1	<b>7,20</b>
FG 626/A17	17		13	24.5	22.0	38.1	<b>7,20</b>
FG 626/A18	18	E22	15	26.0	23.0	38.1	<b>7,20</b>
FG 626/A19	19	E24	16	27.5	24.0	38.1	<b>7,70</b>
FG 626/A20	20			28.5	24.0	38.1	<b>7,70</b>
FG 626/A21	21			28.5	24.0	38.1	<b>7,70</b>

CODE	mm	E	□	B/mm	C/mm	L/mm	€/Pz
FG 626/A22	22	E28		30.5	24.0	38.1	<b>8,00</b>
FG 626/A23	23			28.5	24.0	38.1	<b>8,50</b>
FG 626/A24	24	E30		32.5	25.0	40.0	<b>8,50</b>
FG 626/A27	27	E32		37.0	28.0	42.0	<b>10,50</b>
FG 626/A30	30			41.8	29.0	45.0	<b>12,00</b>
FG 626/A32	32			43.8	30.0	45.0	<b>13,00</b>



## Set of 1/2"dr. UNIVERSAL inch sockets

CODE	Pz	CONTENT	€/Pz
FG 626/S13	13	8,10,11,12,13,14,15,16,17,18,19,20,21 mm	<b>105,00</b>
FG 626/S6	6	22, 23, 24, 27, 30, 32 mm	<b>65,00</b>



## Set of 23pcs 1/2"dr. tools

CODE	Pz	€/Pz
FG 626/S23	23	<b>280,00</b>

**FG 626/A8,10,11,12,13,14,15,16, 17,18,19,20,21,22,24,27,30,32mm**

**FG 625/CR12**

**FG 625/PA125, 250**

**FG 625/ES12**

**FG 625/SN12**

## Soft form of 23pcs 1/2"dr. tools

CODE	Pz	€/Pz
FG 100/20B	23	<b>265,00</b>



**FG 626/A8,10,11,12,13,14,15,16, 17,18,19,20,21,22,24,27,30,32mm**

**FG 625/CR12**

**FG 625/PA125, 250**

**FG 625/ES12**

**FG 625/SN12**



## 1/2"dr. TORX SOCKET WRENCH

→ USE

Torx bolts

→ FINISHING

mirror



CODE	E	A/mm	B/mm	L/mm	€/Pz
FG 625/TX8	8	21.8	17.8	38.1	7,50
FG 625/TX10	10	21.8	15.4	38.1	7,50
FG 625/TX12	12	21.8	17.8	38.1	7,50
FG 625/TX14	14	21.8	20.4	38.1	7,50
FG 625/TX16	16	21.8	21.8	38.1	7,50
FG 625/TX18	18	21.8	21.8	38.1	7,50
FG 625/TX20	20	22.8	22.8	38.1	7,50
FG 625/TX22	22	24.0	25.8	38.1	7,50
FG 625/TX24	24	26.0	27.8	40.0	7,50

## Set of 9pcs 1/2"dr. Torx socket wrenches

CODE	Pz	CONTENT	€/Pz
FG 625TX/S9	9	8, 10, 12, 14, 16, 18, 20, 22, 24 E	78,00

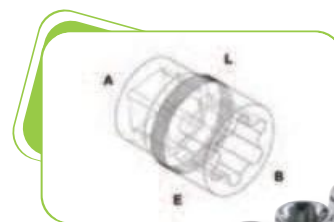

## 1/2"dr. TORX SOCKET WRENCH

→ USE

Torx bolts

→ FINISHING

mirror



CODE	E	A/mm	B/mm	L/mm	€/Pz
FG 625L/TX8	8	21.8	11.8	77.0	12,72
FG 625L/TX10	10	21.8	15.4	77.0	13,50
FG 625L/TX12	12	21.8	17.8	77.0	13,50
FG 625L/TX14	14	21.8	20.4	77.0	13,50
FG 625L/TX16	16	21.8	21.8	77.0	13,50
FG 625L/TX18	18	21.8	21.8	77.0	13,50
FG 625L/TX20	20	23.8	23.8	77.0	13,50
FG 625L/TX22	22	24.0	25.8	77.0	13,50
FG 625L/TX24	24	26.0	27.8	77.0	13,50

## Set of 9pcs 1/2"dr. Torx socket wrenches

CODE	Pz	CONTENT	€/Pz
FG 625LTX/S9	9	8, 10, 12, 14, 16, 18, 20, 22, 24 E	130,00

Soft form of  
44 TORX tools

CODE	Pz	€/Pz
FG 100/21TX	44	255,00

Plastic tray of  
44 TORX tools

CODE	Pz	€/Pz
FG 102/21TX	44	235,00



FG 624/TX4 - TX10

FG 625/TX8 - TX24

FG 147/TX9 - TX40

FG 150/TX10 - TX60

FG 139/C



# 1/2"dr. TORX SOCKET BIT

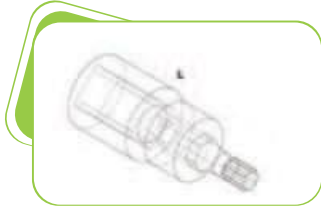

CODE	TX	L/mm	€/Pz
FG 150/TX6	6	55	13,00
FG 150/TX7	7	55	13,00
FG 150/TX8	8	55	13,00
FG 150/TX9	9	55	13,00
FG 150/TX10	10	55	13,00
FG 150/TX15	15	55	13,00
FG 150/TX20	20	55	13,00
FG 150/TX25	25	55	13,00
FG 150/TX27	27	55	13,00
FG 150/TX30	30	55	13,50
FG 150/TX40	40	55	13,50
FG 150/TX45	45	55	14,00
FG 150/TX50	50	55	14,00
FG 150/TX55	55	55	15,50
FG 150/TX60	60	55	16,50
FG 150/TX70	70	55	16,50

CODE	TX	L/mm	€/Pz
FG 150L/TX20	20	100	15,50
FG 150L/TX25	25	100	15,50
FG 150L/TX27	27	100	15,50
FG 150L/TX30	30	100	15,50
FG 150L/TX40	40	100	15,50
FG 150L/TX45	45	100	15,80
FG 150L/TX50	50	100	15,80
FG 150L/TX55	55	100	16,80
FG 150L/TX60	60	100	16,80
FG 150L/TX70	70	100	18,50

**XL**

**XXL**

CODE	TX	L/mm	€/Pz
FG 150XL/TX40	40	140	18,50
FG 150XL/TX45	45	140	18,50
FG 150XL/TX50	50	140	18,50
FG 150XL/TX55	55	140	18,50
FG 150XL/TX60	60	140	25,00
FG 150XL/TX70	70	140	28,00

CODE	TX	L/mm	€/Pz
FG 150XXL/TX40	40	200	25,50
FG 150XXL/TX45	45	200	25,50
FG 150XXL/TX50	50	200	25,50
FG 150XXL/TX55	55	200	25,50
FG 150XXL/TX60	60	200	32,80
FG 150XXL/TX70	70	200	36,50

## Set of 11pcs 1/2"dr. Torx socket bits

CODE	Pz	CONTENT	€/Pz
FG 150TX/S11	11	TX10, TX15, TX20, TX25, TX27, TX30, TX40, TX45, TX50, TX55, TX60	160,00



## Set of 6pcs 1/2"dr. Torx socket bits

CODE	Pz	CONTENT	€/Pz
FG 150LTX/S6	6	TX30, TX40, TX45, TX50, TX55, TX60	102,00



## Set of 32pcs TORX socket bits - 1/2"

CODE	€/Pz
FG 150TX/S32	190,00

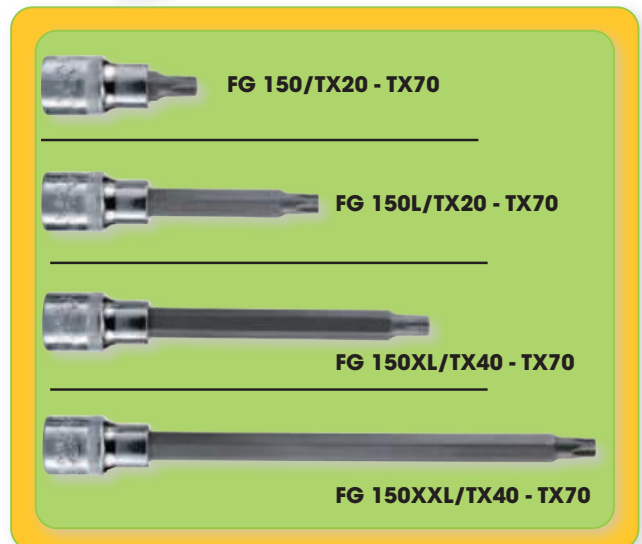



## Set 1/2"dr. and 1/4"dr. TX sockets + TX socket bits

CODE	Pz	€/Pz
FG 625TX/S23	23	225,00



FG 624/TX4, TX5, TX6, TX7, TX8, TX10



FG 625/TX12, TX14, TX16, TX18, TX20, TX22, TX24



FG 150/TX10, TX15, TX20, TX25, TX27, TX30, TX40



FG 625/CR12



FG 625/PA125



## Set 1/2"dr. TX sockets + TX socket bits

CODE	Pz	€/Pz
FG 625TX/S9B	9	75,00



FG 625/TX10, TX12, TX14, TX16, TX18



FG 150/TX25, TX27, TX30, TX40



## Set of 13pcs swivel Torx sockets

CODE	Pz	CONTENT	€/Pz
FG 625TX/S13	13	1/4": E4,E5,E6,E7,E8 3/8": E10,E12,E14,E16 1/2": E18,E20,E22,E24	160,00



## 1/2"dr. XZN SOCKET BIT



**XL**

**XXL**

CODE	M	L/mm	€/Pz
FG 150/M5	5	55	13,00
FG 150/M6	6	55	13,00
FG 150/M8	8	55	13,00
FG 150/M9	9	55	13,00
FG 150/M10	10	55	13,00
FG 150/M12	12	55	13,00
FG 150/M14	14	55	13,00
FG 150/M16	16	55	13,80

CODE	TX	L/mm	€/Pz
FG 150L/M5	5	100	15,50
FG 150L/M6	6	100	15,50
FG 150L/M8	8	100	15,50
FG 150L/M9	9	100	15,50
FG 150L/M10	10	100	15,50
FG 150L/M12	12	100	15,50
FG 150L/M14	14	100	15,50

CODE	TX	L/mm	€/Pz
FG 150XL/M5	5	140	18,50
FG 150XL/M6	6	140	18,50
FG 150XL/M8	8	140	18,50
FG 150XL/M9	9	140	18,50
FG 150XL/M10	10	140	18,50
FG 150XL/M12	12	140	25,50
FG 150XL/M14	14	140	28,00

CÓDIGO	M	L/mm	€/Pz
FG 150XXL/M8	8	200	25,50
FG 150XXL/M10	10	200	25,50
FG 150XXL/M12	12	200	33,00
FG 150XXL/M14	14	200	37,00

### Set of 7pcs 1/2"dr. XZN socket bits

CODE	Pz	CONTENT	€/Pz
FG 150M/S7	7	M5, M6, M8, M10, M12, M14, M16	95,00



### Set of 7pcs 1/2"dr. XZN socket bits

CODE	Pz	CONTENT	€/Pz
FG 150LM/S7	7	LM5, LM6, LM8, LM9, LM10, LM12, LM14	112,00



### Set 1/2"dr. 26pcs socket bits - XZN

CODE	€/Pz
FG 150M/S26	180,00

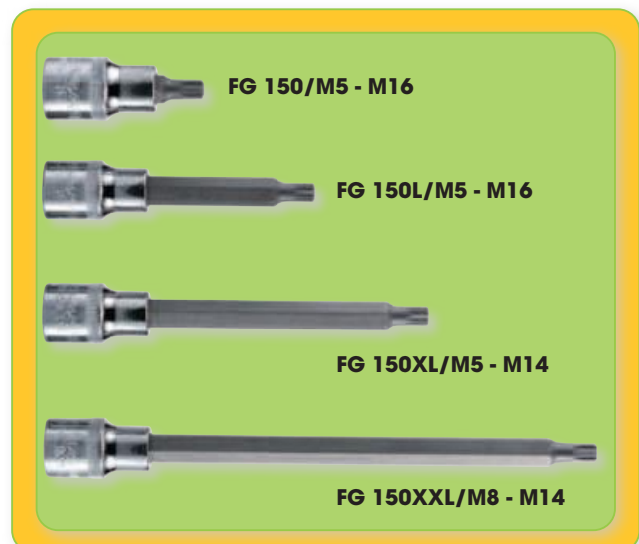

## 1/2"dr. RIBE SOCKET BIT

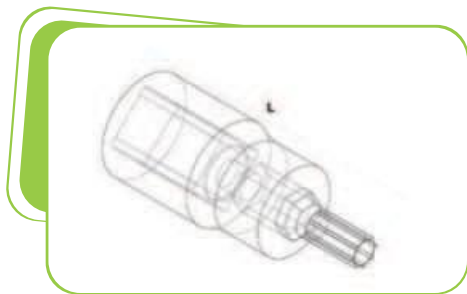

CODE	R	L/mm	€/Pz
FG 150/R4	4	55	13,00
FG 150/R5	5	55	13,00
FG 150/R6	6	55	13,00
FG 150/R7	7	55	13,00
FG 150/R8	8	55	13,00

CODE	R	L/mm	€/Pz
FG 150/R9	9	55	13,00
FG 150/R10	10	55	13,00
FG 150/R11	11	55	13,00
FG 150/R12	12	55	13,00
FG 150/R13	13	55	13,50
FG 150/R14	14	55	13,50

Set of 11pcs 1/2"dr. RIBE socket bits on plastic rail

CODE	Pz	CONTENT	€/Pz
FG 150R/S11	11	R4, R5, R6, R7, R8, R9, R10, R11, R12, R13, R14	140,00



## 1/2"dr. RIBE SOCKET BIT long series

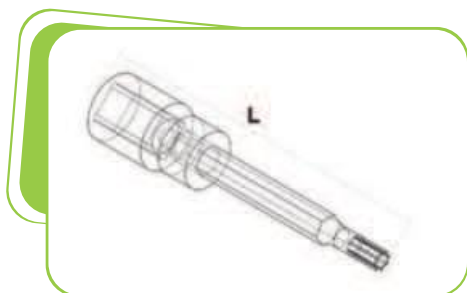

CODE	R	L/mm	€/Pz
FG 150L/R4	4	100	14,50
FG 150L/R5	5	100	14,50
FG 150L/R6	6	100	14,50
FG 150L/R7	7	100	14,50
FG 150L/R8	8	100	14,50

CODE	R	L/mm	€/Pz
FG 150L/R9	9	100	14,50
FG 150L/R10	10	100	14,50
FG 150L/R11	11	100	14,50
FG 150L/R12	12	100	14,50
FG 150L/R13	13	100	14,50
FG 150L/R14	14	100	14,50

Form of 22pcs 1/2"dr. RIBE socket bits

CODE	Pz	CONTENT	€/Pz
FG 100/82B	22	R4 - R14 LR4 - LR14	170,00

Plastic tray of 22pcs 1/2"dr. RIBE socket bits

CODE	Pz	CONTENT	€/Pz
FG 102/21R	22	R4 - R14 LR4 - LR14	220,00



## 1/2"dr. SOCKET BIT FOR HOLED RIBE BOLTS

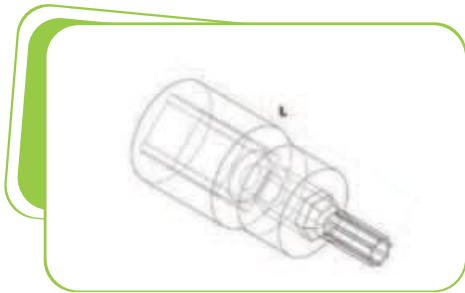

CODE	R	L/mm	€/Pz
FG 150/RF4	4	55	<b>14,50</b>
FG 150/RF5	5	55	<b>14,50</b>
FG 150/RF6	6	55	<b>14,50</b>
FG 150/RF7	7	55	<b>14,50</b>
FG 150/RF8	8	55	<b>15,00</b>

CODE	R	L/mm	€/Pz
FG 150/RF9	9	55	<b>15,00</b>
FG 150/RF10	10	55	<b>15,00</b>
FG 150/RF11	11	55	<b>15,00</b>
FG 150/RF12	12	55	<b>15,00</b>
FG 150/RF13	13	55	<b>15,50</b>
FG 150/RF14	14	55	<b>15,50</b>

**Set of 11 pcs 1/2"dr. holed RIBE socket bits on plastic rail**

CODE	Pz	CONTENT	€/Pz
FG 150RF/S11	11	RF4 - RF14	<b>168,00</b>

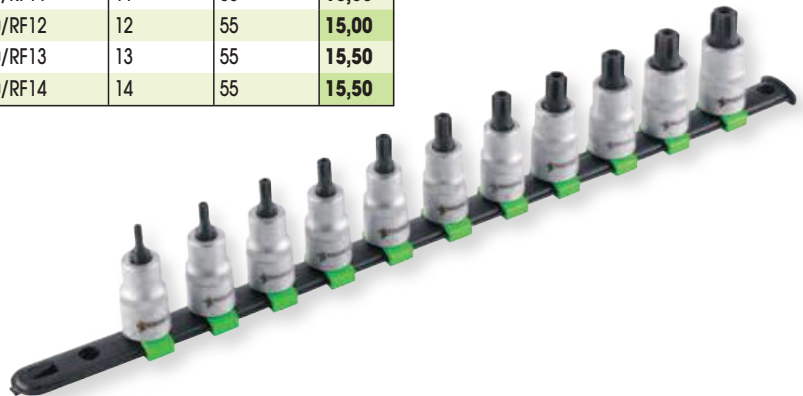

## 1/2"dr. SOCKET BIT FOR HOLED RIBE BOLTS long series

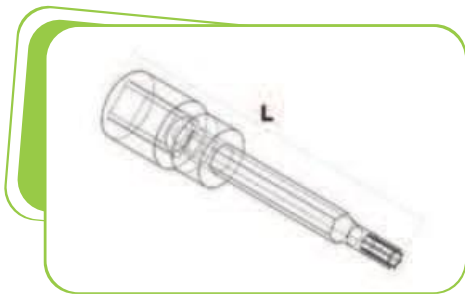

CODE	R	L/mm	€/Pz
FG 150L/RF4	4	100	<b>15,00</b>
FG 150L/RF5	5	100	<b>15,00</b>
FG 150L/RF6	6	100	<b>15,00</b>
FG 150L/RF7	7	100	<b>15,00</b>
FG 150L/RF8	8	100	<b>15,50</b>

CODE	R	L/mm	€/Pz
FG 150L/RF9	9	100	<b>15,50</b>
FG 150L/RF10	10	100	<b>15,50</b>
FG 150L/RF11	11	100	<b>16,00</b>
FG 150L/RF12	12	100	<b>16,00</b>
FG 150L/RF13	13	100	<b>16,00</b>
FG 150L/RF14	14	100	<b>16,50</b>

**Form of 11 pcs 1/2"dr. RIBE socket bits on metal rail**

CODE	Pz	CONTENT	€/Pz
FG 100/83B	22	RF4 - RF14 LRF4 - LRF14	<b>180,00</b>

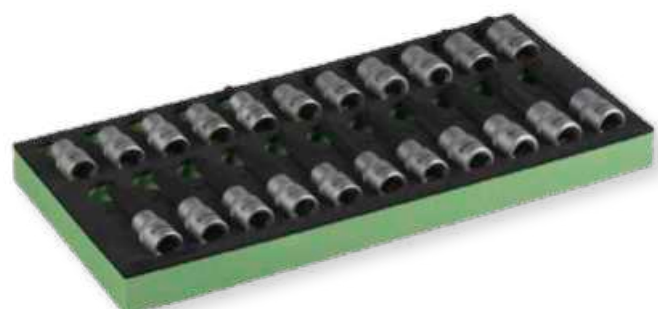



## 1/2"dr. HEX SOCKET BIT

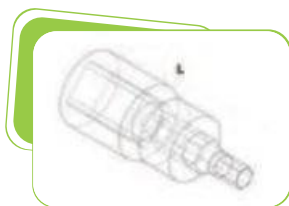

CODE	mm	L/mm	€/Pz	CODE	mm	L/mm	€/Pz
FG 150/H2	2	55	12,00	FG 150L/H2	2	100	12,50
FG 150/H2.5	2.5	55	12,00	FG 150L/H2.5	2.5	100	12,50
FG 150/H3	3	55	12,00	FG 150L/H3	3	100	12,50
FG 150/H4	4	55	12,00	FG 150L/H4	4	100	12,50
FG 150/H5	5	55	12,00	FG 150L/H5	5	100	12,50
FG 150/H6	6	55	12,00	FG 150L/H6	6	100	12,50
FG 150/H8	8	55	12,00	FG 150L/H7	7	100	12,50
FG 150/H10	10	55	12,00	FG 150L/H8	8	100	12,50
FG 150/H12	12	55	14,50	FG 150L/H10	10	100	14,00
FG 150/H14	14	55	14,50	FG 150L/H11	11	100	15,00
FG 150/H17	17	55	16,00	FG 150L/H12	12	100	16,50
FG 150/H19	19	55	17,50	FG 150L/H13	13	100	16,50

XL

CODE	mm	L/mm	€/Pz
FG 150XL/H5	5	140	16,50
FG 150XL/H6	6	140	16,50
FG 150XL/H7	7	140	16,50
FG 150XL/H8	8	140	16,50
FG 150XL/H10	10	140	16,50
FG 150XL/H12	12	140	17,00
FG 150XL/H14	14	140	17,00

XXL

CODE	mm	L/mm	€/Pz
FG 150XXL/H5	5	200	25,00
FG 150XXL/H6	6	200	25,00
FG 150XXL/H7	7	200	25,00
FG 150XXL/H8	8	200	25,00
FG 150XXL/H10	10	200	26,00
FG 150XXL/H12	12	200	30,00

## Set of 12pcs 1/2"dr. hex socket bits

CODE	Pz	CONTENT	€/Pz
FG 150H/S12	12	2, 2.5, 3, 4, 5, 6, 8, 10, 12, 14, 17, 19mm	135,00

## Set of 9pcs 1/2"dr. hex socket bits

CODE	Pz	CONTENT	€/Pz
FG 150H/S9	9	4, 5, 6, 8, 10, 5L, 6L, 8L, 10L mm	115,00



## Set of 30pcs hex socket bits - 1/2"

CODE	€/Pz
FG 150H/S30	200,00



FG 150/H5 - H19



FG 150L/H5 - H13



FG 150XL/H5 - H14



FG 150XXL/H5 - H12

## 1/2"dr. HEX SOCKET BIT WITH BALL HEAD

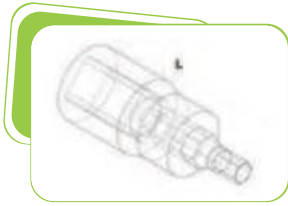

CODE	mm	L/mm	€/Pz
FG 150L/H5B	5	100	14,00
FG 150L/H6B	6	100	14,00
FG 150L/H7B	7	100	14,00
FG 150L/H8B	8	100	14,00
FG 150L/H10B	10	100	14,00

CODE	mm	L/mm	€/Pz
FG 150XXL/H5B	5	200	19,50
FG 150XXL/H6B	6	200	19,50
FG 150XXL/H7B	7	200	19,50
FG 150XXL/H8B	8	200	19,50
FG 150XXL/H10B	10	200	19,50

### Set of 1/2" socket bits with ball head

CODE	Pz	CONTENT	€/Pz
FG 150H/S10B	10	5L,6L,7L,8L,10L,5XXL,6XXL,7XXL,8XXL,10XXL	165,00



## 1/2"dr. XZN socket bit



CODE	mm	L/mm	€/Pz
FG 152/RM5	5	60	12,00
FG 152/RM6	6	60	12,00
FG 152/RM8	8	60	12,00
FG 152/RM9	9	60	12,00
FG 152/RM10	10	78	12,00
FG 152/RM12	12	78	13,50
FG 152/RM14	14	78	13,50
FG 152/RM16	16	78	13,50
FG 152/RM18	18	78	13,50

### Set of 9pcs 1/2"dr. XZN socket bits

RM5, RM6, RM8, RM9, RM10, RM12, RM14, RM16, RM18

CODE	Pz	€/Pz
FG 152RM/S9	9	125,00

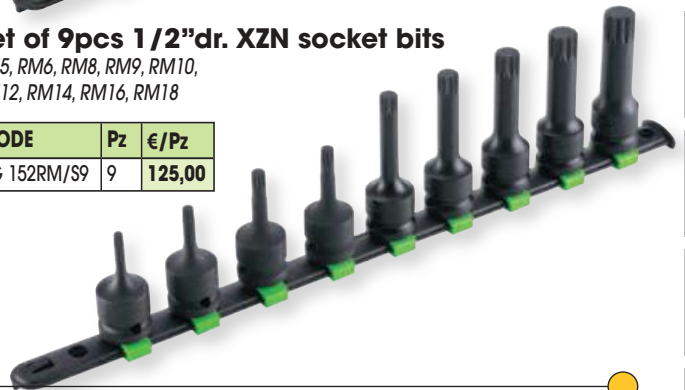

## 1/2"dr. hex socket bit



CODE	mm	L/mm	€/Pz
FG 152/RH5	5	60	12,00
FG 152/RH6	6	60	12,00
FG 152/RH7	7	60	12,00
FG 152/RH8	8	60	12,00
FG 152/RH10	10	68	12,00
FG 152/RH12	12	68	12,00
FG 152/RH14	14	78	14,00
FG 152/RH17	17	78	14,00
FG 152/RH19	19	78	14,00

### Set of 9pcs 1/2"dr. hex socket bits

RH5, RH6, RH7, RH8, RH10, RH12, RH14, RH17, RH19

CODE	Pz	€/Pz
FG 152RH/S9	9	125,00

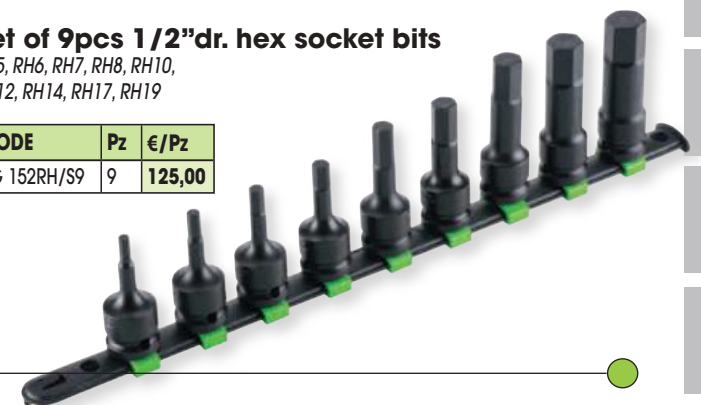

## 1/2"dr. Torx socket bit



CODE	mm	L/mm	€/Pz
FG 152/RTX20	20	60	14,50
FG 152/RTX25	25	60	14,50
FG 152/RTX27	27	60	14,50
FG 152/RTX30	30	60	14,50
FG 152/RTX40	40	60	14,50
FG 152/RTX45	45	68	15,50
FG 152/RTX50	50	68	16,50
FG 152/RTX55	55	68	16,50
FG 152/RTX60	60	68	16,50
FG 152/RTX70	70	78	16,50

### Set of 10pcs 1/2"dr. Torx socket bits

RTX20, RTX25, RTX27, RTX30, RTX40, RTX45, RTX50, RTX55, RTX60, RTX70

CODE	Pz	€/Pz
FG 152/RTXS10	10	165,00

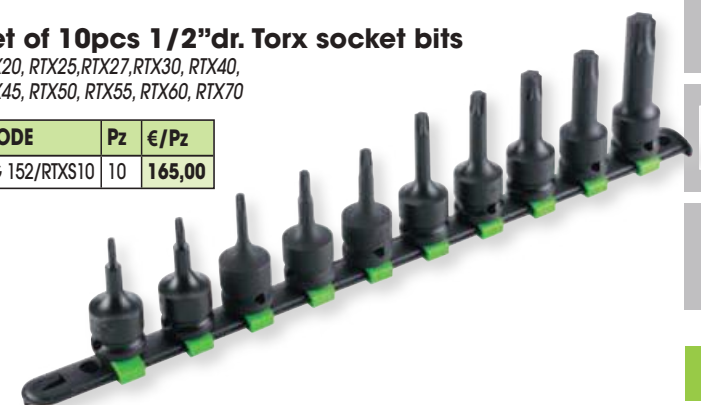



**1/2"dr. reversible ratchet handle**

CODE	L/mm	□	€/Pz
FG 625/CR12	250	1/2"	54,00

- Ring-shaped inversion system integrated on the head
- 72 tooth mechanism
- Mirror finish
- Hook-in slot

**1/4"dr. Reversible ratchet handle - TWISTER HANDLE**

CODE	L/mm	□	€/Pz
FG 625/RT12	260	1/2"	82,00



**1/2"dr. swivel drive with handle**

CODE	L/mm	€/Pz
FG 625/CS12	246	42,00



**1/2"dr. reversible ratchet handle**

CODE	□	€/Pz
FG 625/FR12	1/2"	55,00



- Model with closed dust-proof head
- Integrated reversing lever flush with the head
- 13 ° hollow body to allow use even in particularly difficult spaces
- 72 tooth mechanism
- Mirror finish
- Hook-in slot

**1/2"dr. swivel T-Handle**

CODE	L/mm	€/Pz
FG 625/Q12	500	50,00

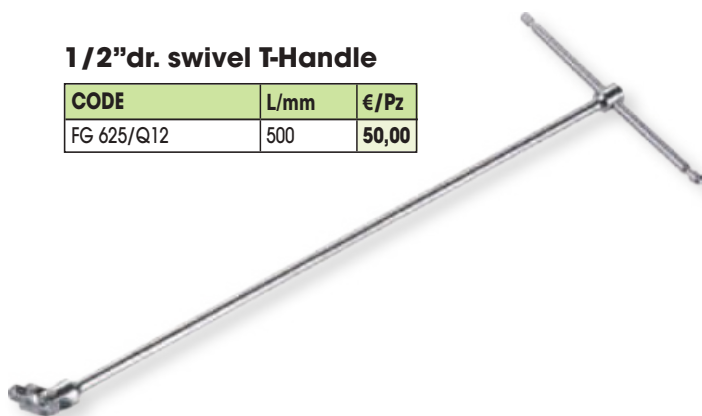

**1/2"dr. sliding bar**

CODE	L/mm	€/Pz
FG 625/ES12	305	16,00



**1/2"dr. Universal joint**

CODE	L/mm	€/Pz
FG 625/SN12	76	22,00



**1/2" female & male drive wobble extension bar**

CODE	L/mm	€/Pz
FG 625/PA50	50	11,00
FG 625/PA75	75	13,00
FG 625/PA125	125	15,50
FG 625/PA250	250	20,00



**1/2" female and male drive extension bar**

CODE	L/mm	€/Pz
FG 625/PR50	50	10,00
FG 625/PR75	75	11,50
FG 625/PR125	125	13,00
FG 625/PR250	250	15,50



**Set of 108pcs 1/4" and 1/2"dr. tools**

CODE	CONTENT	€/Pz
FG BEST 108	108pz	270,00

1/4" 1/2"



**FG BEST 108**

-  **FG 625/A10,11,12,13,14,15,16,17,18,19,20,21,22,23,24,27,30,32**  
**FG 624/E4,4.5,5,5.5,6,7,8,9,10,11,12,13,14**

---

-  **FG 625L/A14,15,17,19,22**  
**FG 624E/L6,7,8,9,10,11,12,13**

---

-  **FG 625/TX10,11,12,14,16,18,20,24**  
**FG 624/TX4,5,6,7,8**

---

-  **FG 181/B16,21 x CANDELE ACCENSIONE**

---

-  **FG 624/CR14**  
**FG 625/CR12**

---

-  **FG 625/SN12**  
**FG 624/SN14**

---

-  **FG 625/ES12**  
**FG 624/ES14**

---

-  **FG 624/GR14**

---

-  **FG 625/PR125**  
**FG 624/PR50,100**

---

-  **FG 87/AD**

---

-  **FG 139/D1.5,2,2.5**

---

-  

**Set of 171pcs 1/4", 3/8" and 1/2"dr. tools**

CODE	CONTENT	€/Pz
FG BEST 171	171pz	400,00

1/4" 3/8" 1/2"



**FG BEST 171**

-  **FG 625/A10,11,12,13,14,15,16,17,18,19,20,21,22,23,24,27,30,32**  
**FG 624/B10,11,12,13,14,15,16,17,18,19**  
**FG 624/E4,4.5,5,5.5,6,7,8,9,10,11,12,13,14**

---

-  **FG 625L/A16,17,18,19,22**  
**FG 624B/L10,11,12,13,14,15**  
**FG 624/4,5,6,7,8,9,10**

---

-  **FG 625/TX20,24**  
**FG 624B/TX10,11,12,14,16,18**  
**FG 624/TX4,5,6,7,8**

---

-  **FG 181/B16,21 x CANDELE ACCENSIONE**

---

-  **FG 624/CR12**  
**FG 624/CR38**  
**FG 625/CR14**

---

-  **FG 625/SN12**  
**FG 624/CR38**  
**FG 624/SN14**

---

-  **FG 625/ES12**  
**FG 624/ES14**

---

-  **FG 624/GR14**

---

-  **FG 625/PR125**  
**FG 624B/PR125**  
**FG 624/PR50,PR100**

---

-  **FG 87/AD**

---

-  **FG 139/D1,1.5,2,2.5,3,4,4.5,5**

---

-  





1/2"

## Set of 27pcs 1/2"dr. tools

CODE	CONTENT	€/Pz
FG 625/S27	27pz	190,00



FG 625/A8,9,10,11,12,13,14,15,16,17,  
18,19,20,21,22,23,24,25,26,27,30,32



FG 625/CR12



FG 625/SN12



FG 625/ES12



FG 625/PA125, 250



1/4"

1/2"

## Set of 110pcs 1/4" and 1/2"dr. tools

CODE	CONTENT	€/Pz
FG 625/S110	110pz	450,00



FG 625/A8,9,10,11,12,13,14,15,16,17,  
18,19,20,21,22,23,24,25,26,27,30,32



FG 624/E4,5,6,7,8,9,10,11,12,13,14



FG 624/CR14  
FG 625/CR12



FG 625/SN12  
FG 624/SN14



FG 625/ES12  
FG 624/ES14



FG 624/GR14C



FG 625/PA125, 250  
FG 624/PA50, 100



FG 89/38PI1 1/4"x1/4"



FG 85/25PH1, PH2, PH3  
FG 85/25SL3, SL4, SL4.5, SL5, SL5.5, SL6, L6.5  
FG 85/25PZ1, PZ2, PZ3  
FG 85/H1.5, H2, 2.5, H3, H4, H5, H6  
FG 85/25T9, T10, T15, T20, T25, T27, T30, T40  
FG 88/60PI2



FG 139/B



FG 48/LG



FG 49



FG 600/B8,10,11,12,  
13,14,15,17,19



FG 22/3x75, 4x100, 5.5x100  
FG 22/PH0x60, PH1x80, PH2x100



FG 59XT/160  
FG 63XT/160



FG 58/B240



FG 132/H500



FG 79/SP



FG 93/M24



FG 44/MT5

### Set of 74pcs 1/4" and 1/2"dr. tools

CODE	CONTENT	€/Pz
FG 625/S74	74pz	250,00



**FG 625/A8,9,10,11,12,13,14,15,16,17, 18,19,20,21,22,23,24,25,26,27,30,32**



**FG 624/E4,5,6,7,8,9,10,11,12,13,14**



**FG 624/CR14  
FG 625/CR12**



**FG 625/SN12  
FG 624/SN14**



**FG 625/ES12  
FG 624/ES14**



**FG 624/GR14C**



**FG 625/PA125  
FG 624/PA50, 100**



**FG 89/38PI1 1/4"x1/4"**



**FG 85/25PH1, PH2, PH3  
FG 85/25SL3, SL4, SL4.5, SL5, SL5.5, SL6, L6.5  
FG 85/25PZ1, PZ2, PZ3  
FG 85/H1.5, H2, 2.5, H3, H4, H5, H6  
FG 85/25T9, T10, T15, T20, T25, T27, T30, T40**

### Set of 94pcs 1/4" and 1/2"dr. tools

CODE	CONTENT	€/Pz
FG 625/S94	94pz	300,00



**FG 625/A8,9,10,11,12,13,14,15,16,17, 18,19,20,21,22,23,24,25,26,27,30,32**



**FG 624/E4,5,6,7,8,9,10,11,12,13,14**



**FG 625L/A10,13,14,15,17,19**



**FG 624E/L4,5,6,7,8,9,10,11,12,13,14**



**FG 624/CR14  
FG 625/CR12**



**FG 625/SN12  
FG 624/SN14**



**FG 625/ES12  
FG 624/ES14**



**FG 624/GR14C**



**FG 625/PA125, 250  
FG 624/PA50, 100**



**FG 89/38PI1 1/4"x1/4"**



**FG 85/25PH1, PH2, PH3  
FG 85/25SL3, SL4, SL4.5, SL5, SL5.5, SL6, L6.5  
FG 85/25PZ1, PZ2, PZ3  
FG 85/H1.5, H2, 2.5, H3, H4, H5, H6  
FG 85/25T9, T10, T15, T20, T25, T27, T30, T40  
FG 88/60PI2**



## 3/4"dr. HEX SOCKET WRENCH

### → USE

hex bolts

### → FINISH

mirror

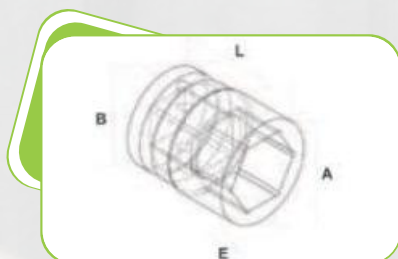

CODE	mm	A/mm	B/mm	E/mm	L/mm	€/Pz
FG 629/A19	19	33.0	29.2	14.0	50.0	13,50
FG 629/A22	22	36.0	32.2	14.0	50.0	14,00
FG 629/A23	23	36.0	33.2	14.0	50.0	14,00
FG 629/A24	24	36.0	33.2	14.0	50.0	15,50
FG 629/A26	26	36.0	37.0	22.0	52.0	16,00
FG 629/A27	27	36.0	38.0	22.0	52.0	16,00
FG 629/A28	28	36.0	39.0	22.0	52.0	16,50
FG 629/A29	29	38.0	40.0	22.0	52.0	16,50
FG 629/A30	30	38.0	42.0	24.0	54.0	18,00
FG 629/A32	32	38.0	44.0	26.0	56.0	18,00

CODE	mm	A/mm	B/mm	E/mm	L/mm	€/Pz
FG 629/A33	33	38.0	46.0	26.0	56.0	19,00
FG 629/A34	34	38.0	47.0	26.0	56.0	19,00
FG 629/A35	35	42.0	48.0	26.0	58.0	20,50
FG 629/A36	36	42.0	50.0	28.0	58.0	21,50
FG 629/A38	38	45.0	52.0	28.0	60.0	22,00
FG 629/A41	41	45.0	56.0	30.0	64.0	24,80
FG 629/A46	46	48.0	62.0	34.0	68.0	33,50
FG 629/A50	50	48.0	68.0	36.0	72.0	38,00
FG 629/A55	55	48.0	74.0	40.0	76.0	47,00
FG 629/A60	60	48.0	80.0	42.0	78.0	55,00

## 3/4"dr. 12PT SOCKET WRENCH

### → USE

hex and  
12PT bolts

### → FINISH

mirror

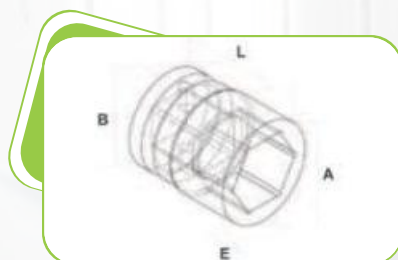

CODE	mm	A/mm	B/mm	E/mm	L/mm	€/Pz
FG 629/B19	19	33.0	29.2	14.0	50.0	13,50
FG 629/B22	22	36.0	32.2	14.0	50.0	14,00
FG 629/B23	23	36.0	33.2	14.0	50.0	14,00
FG 629/B24	24	36.0	33.2	14.0	50.0	15,50
FG 629/B26	26	36.0	37.0	22.0	52.0	16,00
FG 629/B27	27	36.0	38.0	22.0	52.0	16,00
FG 629/B28	28	36.0	39.0	22.0	52.0	16,50
FG 629/B29	29	38.0	40.0	22.0	52.0	16,50
FG 629/B30	30	38.0	42.0	24.0	54.0	18,00
FG 629/B32	32	38.0	44.0	26.0	56.0	18,00

CODE	mm	A/mm	B/mm	E/mm	L/mm	€/Pz
FG 629/B33	33	38.0	46.0	26.0	56.0	19,00
FG 629/B34	34	38.0	47.0	26.0	56.0	19,00
FG 629/B35	35	42.0	48.0	26.0	58.0	20,50
FG 629/B36	36	42.0	50.0	28.0	58.0	21,50
FG 629/B38	38	45.0	52.0	28.0	60.0	22,00
FG 629/B41	41	45.0	56.0	30.0	64.0	24,80
FG 629/B46	46	48.0	62.0	34.0	68.0	33,50
FG 629/B50	50	48.0	68.0	36.0	72.0	38,00
FG 629/B55	55	48.0	74.0	40.0	76.0	47,00
FG 629/B60	60	48.0	80.0	42.0	78.0	55,00



### Set of 3/4"dr. sockets -6PT

CODE	CONTENT	€/Pz
FG 629A/S10	10pz	480,00

### Set of 3/4"dr. sockets -12PT

CODE	CONTENT	€/Pz
FG 629B/S10	10pz	480,00

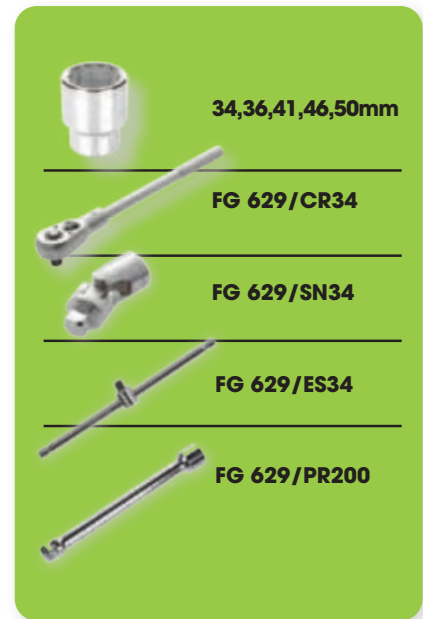

34,36,41,46,50mm

FG 629/CR34

FG 629/SN34

FG 629/ES34

FG 629/PR200

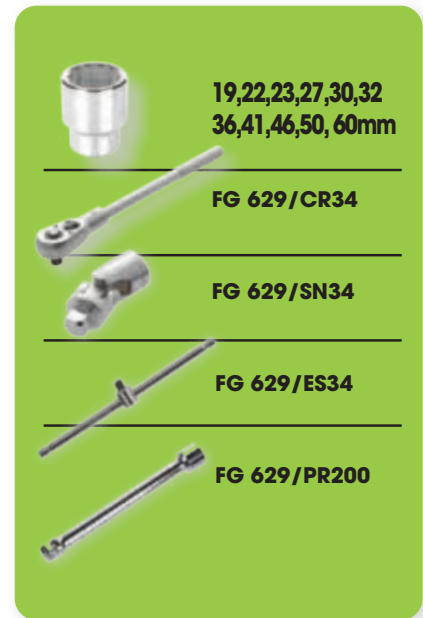

19,22,23,27,30,32  
36,41,46,50, 60mm

FG 629/CR34

FG 629/SN34

FG 629/ES34

FG 629/PR200

### Set of 3/4"dr. sockets -6PT

CODE	CONTENT	€/Pz
FG 629A/S15	15pz	600,00

### Set of 3/4"dr. sockets -12PT

CODE	CONTENT	€/Pz
FG 629B/S15	15pz	600,00



### Form of 3/4"dr. sockets -6PT

CODE	CONTENT	€/Pz
FG 100/25	10pz	420,00

### Form of 3/4"dr. sockets -12PT

CODE	CONTENT	€/Pz
FG 100/25B	10pz	420,00

### Form of 3/4"dr. sockets -6PT

CODE	CONTENT	€/Pz
FG 102/25	10pz	395,00

### Form of 3/4"dr. sockets -12PT

CODE	CONTENT	€/Pz
FG 102/25B	10pz	395,00

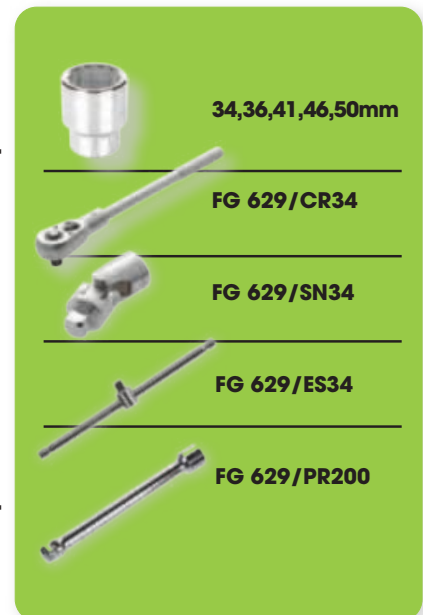

34,36,41,46,50mm

FG 629/CR34

FG 629/SN34

FG 629/ES34

FG 629/PR200







### 3/4"dr. reversible ratchet handle

CODE	■	L/mm	€/Pz
FG 629/CR34	3/4"	500	130,00

### FG 629/CR34R Ratchet parts



### 3/4"dr. male and female drive extension bar

CODE	L/mm	€/Pz
FG 629/PR200	200	28,00
FG 629/PR400	400	42,00



### 3/4"dr. extension bar - L type

CODE	L/mm	€/Pz
FG 629/PRL	455	42,00



### 3/4"dr. sliding bar

CODE	L/mm	€/Pz
FG 629/ES34	405	42,00



### 3/4"dr. swivel handle

CODE	L/mm	€/Pz
FG 629/QS34	500	65,00



### 3/4"dr. universal joint

CODE	L/mm	€/Pz
FG 629/SN34	105	65,00

## 1"dr. 12PT SOCKET WRENCH

→ **USE**  
hex and  
12PT bolts

→ **FINISHING**  
mirror

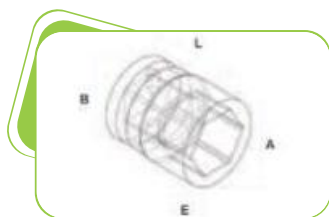

CODE	mm	A/mm	B/mm	E/mm	L/mm	€/Pz
FG 630/B36	36	52.0	55.0	62.0	21.0	<b>35,00</b>
FG 630/B41	41	52.0	61.5	62.0	26.0	<b>35,00</b>
FG 630/B46	46	58.0	68.0	64.0	27.0	<b>40,00</b>
FG 630/B50	50	58.0	72.9	70.0	31.0	<b>46,00</b>
FG 630/B55	55	58.0	79.0	70.0	31.0	<b>50,00</b>
FG 630/B60	60	62.0	87.1	78.0	35.0	<b>58,00</b>
FG 630/B65	65	62.0	93.0	80.0	36.0	<b>77,00</b>
FG 630/B70	70	62.0	98.0	85.0	40.0	<b>78,00</b>
FG 630/B75	75	86.0	103.9	95.0	48.0	<b>92,00</b>
FG 630/B80	80	86.0	110.0	98.0	52.0	<b>105,00</b>

### 1"dr. reversible ratchet handle

CODE	■	L/mm	€/Pz
FG 630/CR1	1"	650	<b>190,00</b>



### 1"dr. male and female drive extension bar

CODE	L/mm	€/Pz
FG 630/PR200	200	<b>50,00</b>
FG 630/PR400	400	<b>70,00</b>



### 1"dr. sliding bar

CODE	L/mm	€/Pz
FG 630/ES1	550	<b>90,00</b>



### Set of 12pcs 1"dr. tools

CODE	PZ	€/Pz
FG 630B/S8	12	<b>1.125,00</b>

46,50,55,60,  
65,70,75,80mm

---

**FG 630/CR1**

---

**FG 630/ES1**

---

**FG 630/PR200**

---

**FG 630/PR400**



## 3/8"dr. impact socket wrenches

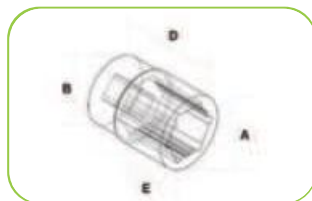

CODE	mm	A/mm	B/mm	D/mm	E/mm	€/Pz
FG 627/C8	8	13,0	17,7	30,0	10,9	6,00
FG 627/C9	9	14,3	17,8	30,0	11,5	6,00
FG 627/C10	10	15,5	17,8	30,0	11,7	6,00
FG 627/C11	11	16,7	17,8	30,0	11,8	6,00
FG 627/C12	10	17,8	17,8	30,0	11,5	6,00
FG 627/C13	13	19,8	19,8	30,0	11,5	6,50
FG 627/C14	14	21,9	21,9	30,0	16,4	6,50
FG 627/C15	15	23,9	23,9	30,0	16,5	6,50
FG 627/C16	16	23,9	23,9	30,0	16,5	6,50
FG 627/C17	17	25,8	25,8	30,0	16,5	6,50
FG 627/C18	18	27,9	27,9	30,0	16,5	6,70
FG 627/C19	19	27,8	27,9	30,0	16,5	6,70
FG 627/C20	20	29,8	29,8	30,0	16,5	7,60
FG 627/C21	21	29,8	29,9	30,0	17,0	7,60
FG 627/C22	22	31,9	31,9	30,0	17,0	8,20

## Set of 15pcs 3/8"dr. impact socket wrenches

CODE	Pz	CONTENT	€/Pz
FG 627/S15B	15	8,9,10, 11, 12, 13, 14, 15, 16, 17, 18, 19, 20, 21, 22mm	102,00

1/2"dr. impact socket  
- long series

CODE	mm	A/mm	B/mm	C/mm	L/mm	€/Pz
FG 628/L10	10	17,5	25	13	80	14,50
FG 628/L11	11	19,0	25	13	80	14,50
FG 628/L12	12	20,0	25	13	80	14,50
FG 628/L13	13	21,0	25	13	80	14,50
FG 628/L14	14	23,0	25	13	80	14,50
FG 628/L15	15	24,0	25	13	80	14,50
FG 628/L16	16	25,0	25	13	80	14,50
FG 628/L17	17	26,5	30	17	80	14,50

CODE	mm	A/mm	B/mm	D/mm	E/mm	€/Pz
FG 628/L18	18	28,0	30	18	80	18,00
FG 628/L19	19	29,0	30	19	80	18,00
FG 628/L21	21	32,0	30	21	80	19,00
FG 628/L22	22	33,0	30	22	80	19,00
FG 628/L23	23	34,0	30	23	80	20,00
FG 628/L24	24	35,0	30	24	80	20,00
FG 628/L25	25	36,5	30	25	80	24,00
FG 628/L27	27	39,0	30	27	80	24,00
FG 628/L29	29	42,5	30	30	80	32,00
FG 628/L30	30	43,5	30	30	80	32,00
FG 628/L32	32	44,5	30	32	80	32,00



## Set of 19pcs 1/2"dr. deep impact sockets

CODE	Pz	CONTENT	€/Pz
FG 628/LS19	19	10, 11, 12, 13, 14, 15, 16, 17, 18, 19, 21, 22, 23, 24, 25, 27, 29, 30, 32 mm	430,00

## 1/2"dr. impact socket wrenches

CODE	mm	A/mm	B/mm	D/mm	E/mm	€/Pz
FG 628/C10	10	15.6	22.6	38.1	7.1	<b>7,80</b>
FG 628/C11	11	17.8	22.6	38.1	8.4	<b>7,80</b>
FG 628/C12	12	18.2	24.3	38.1	9.7	<b>7,80</b>
FG 628/C13	13	19.3	24.3	38.1	9.7	<b>7,80</b>
FG 628/C14	14	22.0	24.3	38.1	10.7	<b>7,80</b>
FG 628/C15	15	23.2	26.6	38.1	10.7	<b>9,00</b>
FG 628/C16	16	24.3	26.6	38.1	11.9	<b>9,00</b>
FG 628/C17	17	25.4	26.6	38.1	12.7	<b>9,00</b>
FG 628/C18	18	26.6	26.6	38.1	12.7	<b>9,00</b>
FG 628/C19	19	28.3	28.3	38.1	12.7	<b>9,00</b>
FG 628/C20	20	29.9	29.9	38.1	14.2	<b>9,00</b>
FG 628/C21	21	31.5	31.5	38.1	14.2	<b>10,00</b>
FG 628/C22	22	33.1	33.3	38.1	14.2	<b>10,00</b>



CODE	mm	A/mm	B/mm	D/mm	E/mm	€/Pz
FG 628/C23	23	34.0	34.0	44.5	16.3	<b>10,50</b>
FG 628/C24	24	34.8	34.8	44.5	16.3	<b>10,50</b>
FG 628/C25	25	36.4	36.4	44.5	19.6	<b>11,60</b>
FG 628/C26	26	37.8	37.8	50.8	19.8	<b>12,80</b>
FG 628/C27	27	39.4	39.4	50.8	20.3	<b>13,00</b>
FG 628/C30	30	43.5	41.5	51.5	21.4	<b>14,00</b>
FG 628/C32	32	44.5	41.5	51.5	21.8	<b>16,20</b>

### Set of 10pcs 1/2"dr. impact socket wrenches

CODE	Pz	CONTENT	€/Pz
FG 628/S10	10	10, 11, 12, 13, 15, 16, 17, 18, 19, 21 mm	<b>105,00</b>



### Set of 20pcs 1/2"dr. impact socket wrenches

CODE	Pz	CONTENT	€/Pz
FG 628/S20	20	10, 11, 12, 13, 14, 15, 16, 17, 18, 19, 20, 21, 22, 23, 24, 25, 26, 27, 30, 32mm	<b>270,00</b>

## 1/2"dr. impact Torx socket wrenches

CODE	E	A/mm	B/mm	D/mm	E/mm	€/Pz
FG 628/TX8	8	13.0	21.8	38.0	14.0	<b>11,00</b>
FG 628/TX10	10	14.0	21.8	38.0	14.0	<b>11,00</b>
FG 628/TX12	12	15.0	21.8	38.0	14.0	<b>12,00</b>
FG 628/TX14	14	17.0	21.8	38.0	14.0	<b>12,00</b>
FG 628/TX16	16	18.0	21.8	38.0	14.0	<b>12,00</b>
FG 628/TX18	18	20.0	21.8	38.0	14.0	<b>12,00</b>
FG 628/TX20	20	24.0	21.8	38.0	14.0	<b>12,00</b>
FG 628/TX22	22	25.8	24.0	38.0	14.0	<b>13,00</b>
FG 628/TX24	24	27.8	26.0	38.0	14.0	<b>13,00</b>

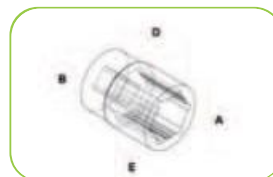

### Set of 9pcs 1/2"dr. TORX impact wrenches on plastic rails

CODE	Pz	CONTENT	€/Pz
FG 628/TXS9	9	E8, E10, E12, E14, E16, E18, E20, E22, E24	<b>110,00</b>



## 1/2"dr. impact Torx socket wrenches

CODE	E	A/mm	B/mm	C/mm	L/mm	€/Pz
FG 628L/TX10	10	13.2	25.0	9.5	70.0	13,00
FG 628L/TX12	12	13.6	25.0	10.5	70.0	13,00
FG 628L/TX14	14	16.4	25.0	12.7	70.0	13,00
FG 628L/TX16	16	19.0	25.0	14.0	70.0	14,00
FG 628L/TX18	18	21.4	25.0	15.0	70.0	14,00
FG 628L/TX20	20	23.5	25.0	17.5	70.0	15,00
FG 628L/TX22	22	26.0	25.0	20.0	70.0	15,00
FG 628L/TX24	24	28.0	25.0	23.4	70.0	15,00

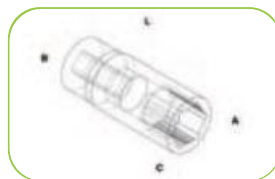

### Set of 8pcs 1/2"dr. TORX impact wrenches on plastic rails

CODE	Pz	CONTENT	€/Pz
FG 628L/TXS8	8	E10, E12, E14, E16, E18, E20, E22, E24	108,00



## 1/2"dr. impact socket wrenches



**EXTRA FLAT**



CODE	mm	A/mm	B/mm	D/mm	E/mm	€/Pz
FG 628/D10	10	17.0	23.8	28.0	7.0	8,50
FG 628/D11	11	18.0	23.9	28.0	5.5	8,50
FG 628/D12	12	19.0	23.9	28.0	7.0	8,50
FG 628/D13	13	19.8	24.0	28.0	8.0	8,50
FG 628/D14	14	22.0	24.0	28.0	6.5	8,50
FG 628/D15	15	24.0	24.0	28.0	7.5	9,50
FG 628/D16	16	24.0	24.0	28.0	7.0	9,50
FG 628/D17	17	26.0	26.0	28.0	8.0	9,50
FG 628/D18	18	28.0	28.0	28.0	7.0	9,50

CODE	mm	A/mm	B/mm	D/mm	E/mm	€/Pz
FG 628/D19	19	28.0	28.0	28.0	8.5	9,50
FG 628/D20	20	30.0	30.0	28.0	8.5	9,50
FG 628/D21	21	30.0	30.0	28.0	8.0	10,50
FG 628/D22	22	32.0	28.0	28.0	9.0	10,50
FG 628/D23	23	33.0	28.0	28.0	9.0	11,20
FG 628/D24	24	34.0	30.0	28.0	9.0	11,20
FG 628/D27	27	38.0	30.0	28.0	10.0	13,50
FG 628/D30	30	42.0	34.0	28.0	10.0	14,50
FG 628/D32	32	44.0	36.0	28.0	9.0	17,00

### Set of 12pcs 1/2"dr. flat impact wrenches on plastic rails

CODE	Pz	CONTENT	€/Pz
FG 628/S12	12	10, 11, 12, 13, 14, 15, 16, 17, 18, 19, 20, 21 mm	130,00

### Set of 6pcs 1/2"dr. flat impact wrenches on plastic rails

CODE	Pz	CONTENIDO	€/Pz
FG 628/S6	6	22, 23, 24, 27, 30, 32mm	95,00

### 1/2" female and male drive impact extension bar

CODE	L/mm	€/Pz
FG 628/PR125	125	14,50
FG 628/PR250	250	15,50
FG 628/PR380	380	20,00

### Set of 3pcs 1/2" female and male drive impact extension bar

CODE	Pz	CONTENT	€/Pz
FG 628PR/S3	3	125, 250, 380mm	50,00

## LOCKNUT SOCKET WITH INSIDE TEETH

- **USE** KM locknuts with INSIDE teeth
- **FINISH** burnished

CODE	KM	FILETTO mm.	D/mm	D1/mm	Num denti	Attacco	€/Pz
FG 631/KM4	4	20x1	32.0	28.0	4	1/2"	46,00
FG 631/KM5	5	25x1.5	38.0	34.0	4	1/2"	50,00
FG 631/KM6	6	30x1.5	45.0	40.0	4	1/2"	60,00
FG 631/KM7	7	35x1.5	52.0	48.0	4	1/2"	70,00
FG 631/KM8	8	40x1.5	58.0	52.0	4	1/2"	70,00
FG 631/KM9	9	45x1.5	65.0	59.0	4	3/4"	80,00
FG 631/KM10	10	50x1.5	70.0	65.0	4	3/4"	95,00
FG 631/KM11	11	55x2	75.0	67.0	4	3/4"	95,00
FG 631/KM12	12	60x2	80.0	73.0	4	3/4"	103,00



## LOCKNUT SOCKET WITH OUTSIDE TEETH

- **USE** KM locknuts with INSIDE teeth
- **FINISH** burnished

CODE	KM	FILETTO mm.	D/mm	D1/mm	Num denti	Attacco	€/Pz
FG 632/KM4	4	20x1	37.5	28.0	4	1/2"	45,00
FG 632/KM5	5	25x1.5	44.5	34.0	4	1/2"	48,00
FG 632/KM6	6	30x1.5	52.5	41.0	4	1/2"	57,00
FG 632/KM7	7	35x1.5	59.5	48.0	4	1/2"	65,00
FG 632/KM8	8	40x1.5	65.5	52.0	4	1/2"	70,00
FG 632/KM9	9	45x1.5	73.5	60.0	4	3/4"	80,00
FG 632/KM10	10	50x1.5	70.0	65.0	4	3/4"	90,00
FG 632/KM11	11	55x2	83.0	69.0	4	3/4"	90,00
FG 632/KM12	12	60x2	88.0	74.0	4	3/4"	95,00



Set of 9pcs locknuts sockets with INSIDE teeth

CODE	Pz	CONTENT	€/Pz
FG 631/S9	9	KM4 - KM12	730,00

Set of 9pcs locknuts sockets with OUTSIDE teeth

CODE	Pz	CONTENT	€/Pz
FG 632/S9	9	KM4 - KM12	770,00



## 3/4"dr. HEX IMPACT SOCKET WRENCH

→ **USE** hex bolts

→ **FINISH** burnished

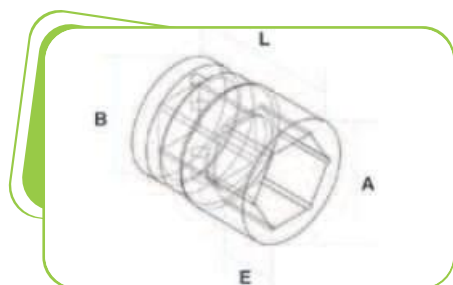

CODE	mm	A/mm	B/mm	E/mm	L/mm	€/Pz
FG 629/C17	17	30.0	44.0	14.0	51.0	<b>22,00</b>
FG 629/C18	18	31.0	44.0	14.0	51.0	<b>22,00</b>
FG 629/C19	19	32.5	44.0	14.0	51.0	<b>22,00</b>
FG 629/C21	21	35.0	44.0	14.0	51.0	<b>22,00</b>
FG 629/C22	22	36.0	44.0	14.0	51.0	<b>22,00</b>
FG 629/C23	23	37.5	44.0	14.0	51.0	<b>22,50</b>
FG 629/C24	24	38.5	44.0	14.0	51.0	<b>22,50</b>
FG 629/C27	27	42.5	44.0	20.0	53.0	<b>22,50</b>
FG 629/C28	28	44.0	44.0	20.0	53.0	<b>22,50</b>
FG 629/C30	30	46.0	44.0	20.0	53.0	<b>22,50</b>
FG 629/C32	32	48.5	44.0	21.0	57.0	<b>23,50</b>

CODE	mm	A/mm	B/mm	E/mm	L/mm	€/Pz
FG 629/C33	33	50.0	44.0	21.0	57.0	<b>25,50</b>
FG 629/C34	34	51.0	44.0	21.0	57.0	<b>25,50</b>
FG 629/C36	36	53.5	44.0	21.0	57.0	<b>27,00</b>
FG 629/C40	40	58.5	44.0	22.0	58.0	<b>32,00</b>
FG 629/C41	41	60.0	44.0	22.0	58.0	<b>32,00</b>
FG 629/C46	46	66.0	44.0	25.0	62.0	<b>38,00</b>
FG 629/C50	50	71.0	44.0	30.0	68.0	<b>48,00</b>
FG 629/C54	54	76.0	54.0	32.0	72.0	<b>50,00</b>
FG 629/C55	55	77.5	54.0	32.0	72.0	<b>52,00</b>
FG 629/C58	58	81.0	54.0	32.0	72.0	<b>60,00</b>
FG 629/C60	60	83.5	54.0	32.0	72.0	<b>65,00</b>



### Set of 10pcs 3/4"dr. impact socket wrenches

CODE	Pz	CONTENT	€/Pz
FG 629C/S10	10	17, 19, 22, 24, 27, 30, 32, 36, 41, 46mm	<b>290,00</b>

## 3/4"dr. HEX IMPACT SOCKET WRENCH long series

→ **USE** hex bolts

→ **FINISH** burnished

CODE	mm	A/mm	B/mm	C/mm	L/mm	€/Pz
FG 629/L17	17	30.0	44.0	26.0	90.0	<b>33,00</b>
FG 629/L19	19	32.5	44.0	26.0	90.0	<b>33,00</b>
FG 629/L21	21	35.0	44.0	26.0	90.0	<b>33,00</b>
FG 629/L22	22	36.0	44.0	26.0	90.0	<b>33,00</b>
FG 629/L24	24	38.5	44.0	26.0	90.0	<b>33,00</b>
FG 629/L26	26	38.5	44.0	28.0	90.0	<b>33,00</b>
FG 629/L27	27	42.5	44.0	28.0	90.0	<b>33,00</b>
FG 629/L30	30	46.0	44.0	28.0	90.0	<b>35,00</b>
FG 629/L32	32	48.5	44.0	28.0	90.0	<b>35,00</b>
FG 629/L33	33	50.0	44.0	30.0	90.0	<b>39,00</b>
FG 629/L34	34	51.0	44.0	30.0	90.0	<b>42,00</b>
FG 629/L36	36	53.5	44.0	30.0	90.0	<b>45,00</b>
FG 629/L38	38	56.0	44.0	34.0	90.0	<b>45,00</b>
FG 629/L41	41	60.0	44.0	34.0	90.0	<b>52,00</b>
FG 629/L46	46	66.0	44.0	34.0	90.0	<b>62,00</b>
FG 629/L50	50	71.0	44.0	36.0	90.0	<b>72,00</b>

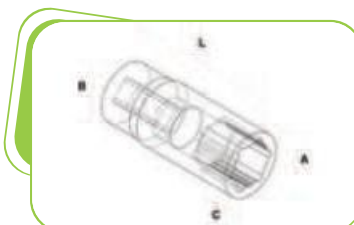

## 1"dr. HEX IMPACT SOCKET WRENCH

- **USE** hex bolts
- **FINISH** burnished

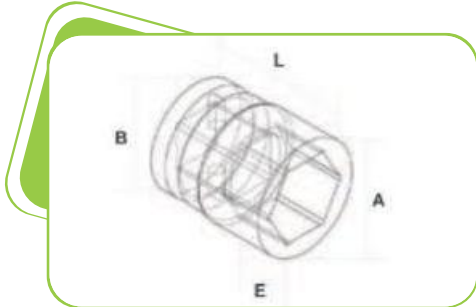

CODE	mm	A/mm	B/mm	L/mm	E/mm	€/Pz
FG 630/A24	24	53.96	41.53	57.0	30.13	<b>34,00</b>
FG 630/A27	27	53.98	45.24	56.92	21.46	<b>34,00</b>
FG 630/A30	30	48.94	53.95	61.88	27.41	<b>34,00</b>
FG 630/A32	32	51.42	53.88	62.0	28.47	<b>35,00</b>
FG 630/A33	33	52.73	53.25	61.87	28.16	<b>35,00</b>
FG 630/A34	34	53.91	53.94	61.80	25.88	<b>35,00</b>
FG 630/A36	36	56.50	54.07	62.06	26.50	<b>35,00</b>
FG 630/A38	38	58.88	54.0	65.93	30.0	<b>43,00</b>

CODE	mm	A/mm	B/mm	L/mm	E/mm	€/Pz
FG 630/A41	41	62.8	54.18	66.04	28.27	<b>45,00</b>
FG 630/A46	46	68.70	53.96	70.24	30.6	<b>49,00</b>
FG 630/A50	50	73.9	54.0	70.0	30.8	<b>62,00</b>
FG 630/A55	55	80.05	53.91	81.9	34.32	<b>67,00</b>
FG 630/A60	60	86.56	54.2	84.88	27.11	<b>82,00</b>
FG 630/A65	65	92.7	53.96	85.25	37.97	<b>92,00</b>
FG 630/A70	70	97.88	61.91	84.71	37.27	<b>105,00</b>
FG 630/A75	75	103.9	85.87	94.91	47.95	<b>138,00</b>
FG 630/A80	80	111.48	60.5	90.5	41.57	<b>145,00</b>



### Set of 14pcs 1"dr. impact socket wrenches

CODE	Pz	CONTENT	€/Pz
FG 630A/S14	14	24, 27, 30, 32, 33, 34, 36, 38, 41, 46, 50, 55, 60, 65mm	<b>830,00</b>

## 1"dr. HEX IMPACT SOCKET WRENCH long series

- **USE** hex bolts
- **FINISH** burnished

CODE	mm	A/mm	B/mm	C/mm	L/mm	€/Pz
FG 630/L24	24	51.0	51.0	17.0	108.0	<b>58,00</b>
FG 630/L27	27	51.0	51.0	17.0	108.0	<b>60,00</b>
FG 630/L30	30	51.0	51.0	21.0	108.0	<b>60,00</b>
FG 630/L32	32	51.0	51.0	21.0	108.0	<b>61,00</b>
FG 630/L33	33	52.0	52.0	21.0	108.0	<b>63,00</b>
FG 630/L34	34	52.0	52.0	21.0	108.0	<b>68,00</b>
FG 630/L36	36	52.0	52.0	21.0	108.0	<b>68,00</b>
FG 630/L41	41	52.0	61.5	26.0	108.0	<b>74,00</b>
FG 630/L46	46	52.0	61.5	26.0	108.0	<b>79,00</b>
FG 630/L50	50	58.0	68.0	27.0	108.0	<b>89,00</b>
FG 630/L55	55	58.0	72.9	31.0	108.0	<b>124,00</b>
FG 630/L60	60	58.0	79.0	31.0	108.0	<b>143,00</b>
FG 630/L65	65	62.0	87.1	35.0	108.0	<b>163,00</b>
FG 630/L70	70	62.0	93.0	36.0	108.0	<b>185,00</b>







Hand adaptor

1/4"

CODE	□	■	L/mm	€/Pz
FG 624/AD1	1/4"	3/8"	28	5,50



Hand adaptor

3/8"

CODE	□	■	L/mm	€/Pz
FG 624/AD2	3/8"	1/4"	30	6,80
FG 624/AD3	3/8"	1/2"	30	8,00



Hand adaptor

1/2"

CODE	□	■	L/mm	€/Pz
FG 625/AD1	1/2"	1/4"	28	10,00
FG 625/AD2	1/2"	3/8"	30	10,50
FG 625/AD3	1/2"	3/4"	28	12,00



Hand adaptor

3/4"

CODE	□	■	L/mm	€/Pz
FG 629/AD3	3/4"	1/2"	30	15,00

Set of 7pcs hand adaptors  
+ 3pcs universal joints

CODE	CONTENT □ x ■	€/Pz
FG 625AD/S10	1/4"x3/8", 3/8"x1/4", 3/8"x1/2", 1/2"x1/4", 1/2"x3/8", 1/2"x3/4", 3/4"x1/2"	75,00



Magnetic hand adaptor - SUPER FLAT

CODE	□	■	L/mm	€/Pz
FG 624/AM1	1/4"	3/8"	13.6	9,00
FG 624/AM2	3/8"	1/2"	18.4	12,00
FG 625/AM1	1/2"	3/4"	27.5	18,00



Set of 3pcs magnetic hand adaptor - SUPER FLAT

CODE	CONTENT □ x ■	€/Pz
FG 625AM/S3	1/4"x3/8", 3/8"x1/2", 1/2"x3/4"	48,00

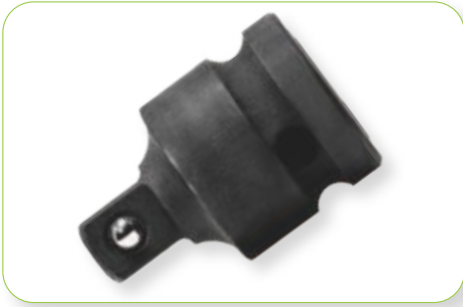

### Impact adaptor

CODE	□	■	L/mm	€/Pz
FG 624/AD4	1/4"	3/8"	28	12,00

1/4"

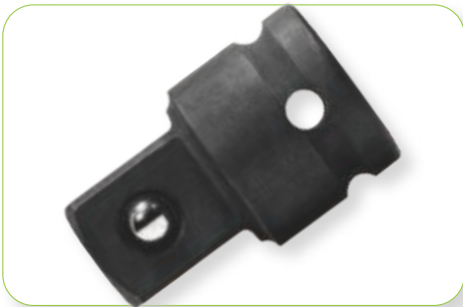

### Impact adaptor

CODE	□	■	L/mm	€/Pz
FG 624/AD5	3/8"	1/2"	30	15,00

3/8"



### Impact adaptor

CODE	□	■	L/mm	€/Pz
FG 628/AD1	1/2"	1/4"	28	11,00
FG 628/AD2	1/2"	3/8"	30	12,00
FG 628/AD3	1/2"	3/4"	28	21,00

1/2"



### Impact adaptor

CODE	□	■	L/mm	€/Pz
FG 629/AD1	3/4"	1/2"	30	29,00
FG 629/AD2	3/4"	1"	28	33,00

3/4"

CODE	FOR:	€/Pz
FG 629/AS1	Coppia di spina + anello 3/4"	5,00



### Impact adaptor

CODE	□	■	L/mm	€/Pz
FG 630/AD1	1"	3/4"	30	45,00

1"

CODE	FOR:	€/Pz
FG 630/AS1	Ring + pin 1" Fema	7,00



### Male and female universal joint

CODE	L/mm	€/Pz
FG 625/SN12R	105	35,00
FG 629/SN34R	105	70,00

1/2"

3/4"





# 03

**SCREWDRI VERS,  
BITS AND PLIERS**



### Screwdriver for slotted head screws - DIN ISO 2380



CODE	AxB mm	D1 x L1 mm	D2 x L2 mm	L/mm	Minimum	€/Pz
FG 22/2.5x60	2.5x0.4	2.5X60	28.9X100.9	161	5pz	5,10
FG 22/2.5x75	2.5x0.4	2.5X75	28.9X100.9	176	5pz	5,10
FG 22/3x75	3.0x0.5	3.0X75	28.9X100.9	176	5pz	5,10
FG 22/3x100	3.0x0.5	3.0X100	28.9X100.9	201	5pz	5,30
FG 22/3.5x100	3.5x0.6	3.5X100	28.9X100.9	201	5pz	5,50
FG 22/3.5x125	3.5x0.6	3.5X125	28.9X100.9	226	5pz	5,60
FG 22/4x100	4.0x0.8	4.0X100	28.9X100.9	201	5pz	5,80
FG 22/4x125	4.0x0.8	4.0X125	28.9X100.9	226	5pz	6,00
FG 22/4x150	4.0x0.8	4.0X150	28.9X100.9	251	5pz	6,10
FG 22/5.5x100	5.5x1.0	5.0X100	32.7X114.0	214	5pz	6,40
FG 22/5.5x150	5.5x1.0	5.5X150	32.7X114.0	264	5pz	7,40
FG 22/5.5x200	5.5x1.0	5.5X200	32.7X114.0	314	5pz	7,40
FG 22/6.5x100	6.5x1.2	6.5X100	36.0X125.0	225	5pz	7,90
FG 22/6.5x150	6.5x1.2	6.5X150	36.0X125.0	275	5pz	8,20
FG 22/8x150	8.0x1.2	8.0X150	39.4X136.6	287	3pz	10,70
FG 22/8x200	8.0x1.2	8.0X200	39.4X136.6	337	3pz	12,30
FG 22/10x200	10.0x1.6	10.0X200	39.4X136.6	337	3pz	14,50
FG 22/12x250	12.0x1.7	12.0X250	39.4X136.6	387	3pz	15,20

CODE	AxB mm	D1 x L1 mm	D2 x L2 mm	L/mm	Minimum	€/Pz
FG 22/4x30	4.0x0.8	4X30	35.4X63.5	93.5	5pz	6,20
FG 22/6.5x30	6.5x1.2	6.5x30	35.4x63.5	93.5	5pz	6,40

### Set of screwdrivers for slotted head screws

CODE	CONTENT	€/Pz
FG 22SL/S5	2.5x75, 3x75, 4x125, 5.5x150, 6.5x150	35,00
FG 22SL/S9	2.5x60, 3x100, 3x75, 4x125, 5.5x150, 6.5x30, 6.5x150, 8x200, 10x200	75,00
FG 22SL/S12	2.5x60, 3x100, 3.5x125, 4x100, 4x150, 5.5x100, 5.5x150, 6.5x30, 6.5x150, 8x200, 10x200, 12x250	102,00

### Screwdriver for PH cross head screws - DIN ISO 8764

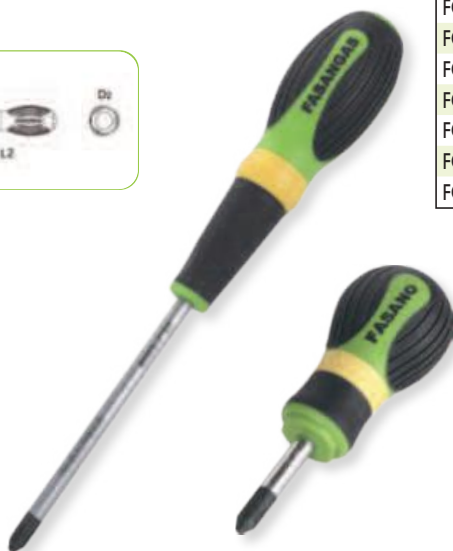
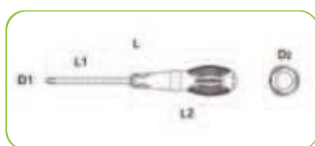

CODE	PH	D1 x L1 mm	D2 x L2 mm	L/mm	Minimum	€/Pz
FG 22/PH0x60	0	3x60	28.9x101	160	5pz	5,00
FG 22/PH1x80	1	5x80	32.7x114	194	5pz	6,40
FG 22/PH1x150	1	5x150	32.7x114	264	5pz	6,50
FG 22/PH1x200	1	5x200	32.7x114	314	5pz	7,60
FG 22/PH2x100	2	6x100	36.0x125	225	5pz	8,00
FG 22/PH2x150	2	6x150	36.0x125	275	5pz	8,50
FG 22/PH2x200	2	6x200	36.0x129	325	5pz	9,00
FG 22/PH3x150	3	8x150	39.4x137	287	3pz	10,80
FG 22/PH4x200	4	9.5x200	39.4x137	337	3pz	14,00

### Screwdriver for PH cross head screws stubby series - DIN ISO 8764

CODE	PH	D1xL1mm	D2xL2mm	L/mm	Q.ia min.	€/Pz
FG 22/PH1x30	1	5x30	35.4x63x5	93.5	5pz	6,00
FG 22/PH2x30	2	6x30	35.4x63.5	93.5	5pz	6,30

### Set of screwdrivers for cross head PH screws

CODE	CONTENT	€/Pz
FG 22PH/S4	PH0x60, PH1x80, PH2x100, PH3x150	34,00
FG 22PH/S6	PH0x60, PH1x80, PH1x150, PH2x100, PH3x150, PH4x200	54,00
FG 22PH/S8	PH0x60, PH1x30, PH1x80, PH1x150, PH2x30, PH2x100, PH3x150, PH4x200	68,00



### Screwdriver for PZ cross head screws - DIN ISO 8764

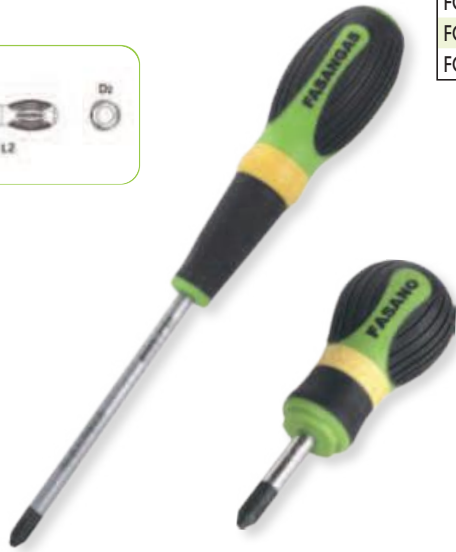
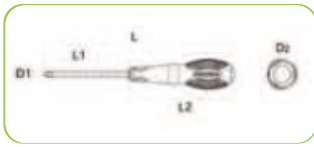

CODE	PH	D1 x L1 mm	D2 x L2 mm	L/mm	Minimum	€/Pz
FG 22/PZ0x60	0	3x60	29.9x101	161	5pz	5,30
FG 22/PZ1x80	1	5x80	32.7x114	194	5pz	6,40
FG 22/PZ2x100	2	6x100	36.0x125	225	5pz	7,60
FG 22/PZ3x150	3	8x150	39.4x135	286	3pz	11,00
FG 22/PZ4x200	4	9.5x200	39.4x137	337	3pz	13,60

### Screwdriver for PZ cross head screws stubby series - DIN ISO 8764

CODE	PZ	D1xL1mm	D2xL2mm	L/mm	Q.tà min.	€/Pz
FG 22/PZ1x30	1	5x30	35.4x63.5	93.5	5pz	6,00
FG 22/PZ2x30	2	6x30	35.4x63.5	93.5	5pz	6,10

### Set of screwdrivers for cross head Pozidriv screws

CODE	CONTENT	€/Pz
FG 22PZ/S4	PZ0x60, PZ1x80, PZ2x100, PZ3x150	33,00
FG 22PZ/S5	PZ0x60, PZ1x80, PZ2x100, PZ3x150, PZ4x200	47,00
FG 22PZ/S7	PZ0x60, PZ1x30, PZ1x80, PZ2x30, PZ2x100, PZ3x150, PZ4x200	60,00

### Set of screwdrivers for slotted and PH cross head screws

CODE	CONTENT	€/Pz
FG 22/S6	3x75, 4x100, 5.5x100 PH0x60, PH1x80, PH2x100	36,00
FG 22/S8	3x75, 4x100, 5.5x100, 6.5x30 PH0x60, PH1x80, PH2x100, PH2x30	48,00
FG 22/S8B	2.5x75, 3.5x100, 4x100, 6.5x150, 8x150 PH0x60, PH1x80, PH2x150	52,00

### Set of screwdrivers for slotted and Pozidriv cross head screws

CODE	CONTENT	€/Pz
FG 22/S10	2.5x60, 3x75, 4x100, 5.5x150, 6.5x150, 6.5x30 PH0x60, PH1x80, PH2x100, PH1x30	65,00
FG 22/S12	2.5x60, 3x75, 4x100, 5.5x150, 6.5x150, 8x150, 6.5x30 PH0x60, PH1x80, PH2x100, PH3x150, PH1x30	90,00

### Set of screwdrivers for slotted and Phillips cross head screws

CODE	CONTENT	€/Pz
FG 22/S7	3x75, 4x100, 5.5x150, 6.5x150 PZ0x60, PZ1x80, PZ2x100	50,00



## Screwdrivers with hexagon bolster - DIN ISO 2380

CODE	AxB mm	D1xL1mm	D2xL2mm	L/mm	Min. Q.ty	€/Pz
FG 22/5.5x125H	5.5x1.0	5.5x125	36.0x125	250	3pz	6,50
FG 22/6.5x150H	6.5x1.2	6.5x150	39.4x137	287	3pz	8,50
FG 22/8x175H	8.0x1.2	8x175	39.4x137	312	3pz	10,50
FG 22/10x200H	10x1.6	9.5x200	39.4x137	337	2pz	13,00
FG 22/12x200H	12x1.8	12x200	39.4x137	337	2pz	14,50

CODE	PH	D1xL1mm	D2xL2mm	L/mm	Q.tà min.	€/Pz
FG 22/PH2x100H	2	8x100	39.4x137	237	3pz	9,50
FG 22/PH3x150H	3	8x150	39.4x137	287	3pz	11,00
FG 22/PH4x200H	4	9.5x200	39.4x137	337	2pz	14,50



## Set of screwdrivers with hexagon bolster - slotted and Phillips

CODE	CONTENT	€/Pz
FG 22/S8H	5.5x125, 6.5x150, 8x175, 10x200, 12x200 PH2x100, PH3x150, PH4x200	90,00



## Extra-long screwdrivers

CODE	AxB mm	D1xL1mm	D2xL2mm	L/mm	Min. Q.ty	€/Pz
FG 22/2.5x200	2.5x0.4	2.5x200	28.9x114	300	3pz	7,40
FG 22/2.5x300	2.5x0.4	3x300	28.9x100.9	400	3pz	8,90
FG 22/4x400	4.0x0.8	4x400	28.9x100.9	500	3pz	11,20
FG 22/5x400	7.5x1.0	5x400	28.9x100.9	514	3pz	13,00
FG 22/6.5x400	8.8x1.2	6.5x400	28.9x100.9	525	3pz	16,20

CODE	PH	D1xL1mm	D2xL2mm	L/mm	Q.tà min.	€/Pz
FG 22/PH0x300	0	3x300	28.9x100	400	3pz	12,00
FG 22/PH1x400	1	5x400	32.7x114	514	3pz	14,50
FG 22/PH2x400	2	6x400	36.0x125	525	3pz	14,00



## Set of extra-long screwdrivers for slotted and Phillips screws

CODE	CONTENT	€/Pz
FG 22XL/S6	2.5x200, 4x400, 5x400, 6.5x400, PH0x300, PH1x400	67,00
FG 22XL/S8	2.5x200, 2.5x300, 4x400, 5x400, 6.5x400, PH0x300, PH1x400, PH2x400	92,00



## Angle screwdrivers

CODE	mm	L/mm	Min. Q.ty	€/Pz
FG 22/OF4	4.0x4.0	100	03pz	4,80
FG 22/OF5	5.5x5.5	125	03pz	5,30
FG 22/OF8	8.0x8.0	150	03pz	7,50

CODE	PH	L/mm	Q.tà min.	€/Pz
FG 22/PH12	PH1 - PH2	125	03pz	5,40
FG 22/PH34	PH3 - PH4	200	03pz	10,20



## Ball head hexagon drive with handle

CODE	mm	D1xL1mm	D2xL2mm	L/mm	Min. Q.ty	€/Pz
FG 22/H2	2	2.0x75	28.9x101	176	3pz	6,00
FG 22/H2.5	2.5	2.5x75	28.9x101	176	3pz	6,10
FG 22/H3	3	3x100	28.9x101	201	3pz	6,20
FG 22/H4	4	4x100	28.9x101	201	3pz	7,00
FG 22/H5	5	5.0x100	32.7x114	214	3pz	8,00
FG 22/H6	6	6.0x125	36.0x125	250	2pz	9,00
FG 22/H8	8	8.0x150	39.4x136.6	287	2pz	11,50



## Set of 7 ball head hexagon drives

CODE	€/Pz
FG 22H/S7	55,00

- 2, 2.5, 3, 4, 5, 6, 8mm



## Screwdrivers for Torx head screws

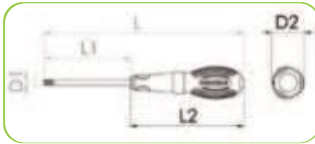

CODE	TX	D1 x L1 mm	D2 x L2 mm	L/mm	Minimum	€/Pz
FG 22/TX6	6	4.0x75	28.9x101	176	5pz	8,00
FG 22/TX7	7	4.0x75	28.9x101	176	5pz	8,00
FG 22/TX8	8	4.0x75	28.9x101	176	5pz	9,30
FG 22/TX9	9	4.0x75	28.9x101	176	5pz	9,30
FG 22/TX10	10	5.0x100	32.7x114	214	5pz	9,30
FG 22/TX15	15	5.0x100	32.7x114	214	5pz	10,50
FG 22/TX20	20	5.0x100	32.7x114	214	5pz	10,50
FG 22/TX25	25	6.0x100	36.0x125	225	5pz	10,50
FG 22/TX27	27	6.0x100	36.0x125	225	5pz	12,00
FG 22/TX30	30	6.0x100	36.0x125	225	5pz	13,50
FG 22/TX40	40	7.0x100	36.0x125	225	3pz	11,40
FG 22/TX45	45	8.0x100	39.4x136.6	237	3pz	12,90

## Set of screwdrivers for Torx head screws

CODE	CONTENT	€/Pz
FG 22TX/S6	TX10, TX15, TX20, TX25, TX27, TX30	65,00

## Set of screwdrivers for Torx head screws

CODE	CONTENT	€/Pz
FG 22TX/S8	TX10, TX15, TX20, TX25, TX27, TX30, TX40, TX45	86,00
FG 22TX/S12	TX6, TX7, TX8, TX9, TX10, TX15, TX20, TX25, TX27, TX30, TX40, TX45	115,00

## Screwdrivers for Tamper Resistant Torx head screws

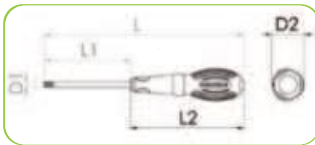

CODE	TX	D1 x L1 mm	D2 x L2 mm	L/mm	Minimum	€/Pz
FG 22/RTX6	6	4.0x75	28.9x101	176	3pz	8,60
FG 22/RTX7	7	4.0x75	28.9x101	176	3pz	8,60
FG 22/RTX8	8	4.0x75	28.9x101	176	3pz	8,60
FG 22/RTX9	9	4.0x75	28.9x101	176	3pz	8,60
FG 22/RTX10	10	5.0x100	32.7x114	214	3pz	9,40
FG 22/RTX15	15	5.0x100	32.7x114	214	3pz	9,70
FG 22/RTX20	20	5.0x100	32.7x114	214	3pz	10,00
FG 22/RTX25	25	6.0x100	36.0x125	225	3pz	10,30
FG 22/RTX27	27	6.0x100	36.0x125	225	3pz	10,60
FG 22/RTX30	30	6.0x100	36.0x125	225	3pz	11,50
FG 22/RTX40	40	7.0x100	36.0x125	225	2pz	11,90
FG 22/RTX45	45	8.0x100	39.4x136.6	237	2pz	13,50

## Set of screwdrivers for Tamper Resistant Torx head screws

CODE	CONTENT	€/Pz
FG 22RTX/S6	RTX10, RTX15, RTX20, RTX25, RTX27, RTX30	66,00

## Set of screwdrivers for Tamper Resistant Torx head screws

CODE	CONTENT	€/Pz
FG 22RTX/S8	RTX10, RTX15, RTX20, RTX25, RTX27, RTX30, RTX40, RTX45	90,00
FG 22RTX/S12	RTX6, TX7, RTX8, RTX9, RTX10, RTX15, RTX20, RTX25, RTX27, RTX30, RTX40, RTX45	125,00





### Screwdrivers for Torx head screws - extra long series



CODE	TX	D1xL1mm	D2xL2mm	L/mm	Min. Q.ty	€/Pz
FG 22XL/TX6	6	4.0x400	28.9x101	501	3pz	11,10
FG 22XL/TX7	7	4.0x400	28.9x101	501	3pz	11,10
FG 22XL/TX8	8	4.0x400	28.9x101	501	3pz	11,10
FG 22XL/TX9	9	4.0x400	28.9x101	501	3pz	11,10
FG 22XL/TX10	10	5.0x400	32.7x114	514	3pz	13,50
FG 22XL/TX15	15	5.0x400	32.7x114	514	3pz	13,50
FG 22XL/TX20	20	5.0x400	32.7x114	514	3pz	13,50
FG 22XL/TX25	25	6.0x400	36.0x125	525	3pz	16,90
FG 22XL/TX27	27	6.0x400	36.0x125	525	3pz	16,90
FG 22XL/TX30	30	6.0x400	36.0x125	525	3pz	16,90
FG 22XL/TX40	40	7.0x400	36.0x125	525	3pz	16,90



### Set of screwdrivers for Torx head screws - extra long series

CODE	CONTENT	€/Pz
FG 22TX/LS8	TX8, 10, 15, 20, 25, 27, 30, 40	122,00
FG 22TX/LS11	TX6, 7, 8, 9, 10, 15, 20, 25, 27, 30, 40	155,00



### Flexible hexagon nut spinners with handle - DIN 3125

CODE	mm	D1xL1mm	D2xL2mm	L/mm	Min. Q.ty	€/Pz
FG 22/FL5	5	6.0x150	36.0x125	275	5pz	21,00
FG 22/FL5.5	5.5	6.0x150	36.0x125	275	5pz	21,00
FG 22/FL6	6	6.0x150	36.0x125	275	5pz	21,00
FG 22/FL7	7	6.0x150	36.0x125	275	5pz	21,00
FG 22/FL8	8	6.0x150	36.0x125	275	3pz	21,00
FG 22/FL10	10	6.0x150	36.0x125	275	3pz	21,00

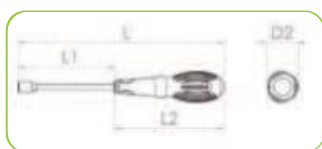

### Set of flexible hexagon nut spinners with handle

CODE	CONTENT	€/Pz
FG 22FL/S6	5, 5.5, 6, 7, 8, 10 mm	127,00



### Hexagon nut spinner with handle - DIN 3125

CODE	mm	D1xL1mm	D2xL2mm	L/mm	Min. Q.ty	€/Pz
FG 22/FX5	5	6.0x125	36.0x125	250	5pz	12,00
FG 22/FX5.5	5.5	6.0x125	36.0x125	250	5pz	12,00
FG 22/FX6	6	6.0x125	36.0x125	250	5pz	12,00
FG 22/FX7	7	6.0x125	36.0x125	250	5pz	13,50
FG 22/FX8	8	6.0x125	36.0x125	250	5pz	13,50
FG 22/FX9	9	6.0x125	36.0x125	250	5pz	13,50
FG 22/FX10	10	6.0x125	36.0x125	250	5pz	14,50
FG 22/FX11	11	6.0x125	36.0x125	250	3pz	14,50
FG 22/FX12	12	6.0x125	36.0x125	250	3pz	14,50
FG 22/FX13	13	6.0x125	36.0x125	250	3pz	16,00

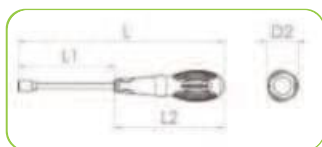

### Set of hexagon nut spinners with handle

CODE	CONTENT	€/Pz
FG 22FX/S6	6, 7, 8, 9, 10, 12 mm	85,50
FG 22FX/S9B	5, 5.5, 7, 8, 9, 10, 12, 13 mm	125,50
FG 22FX/S10	5, 5.5, 6, 7, 8, 9, 10, 11, 12, 13 mm	140,00



## Offset hexagon key wrenches - short series

CODE	mm	L1/mm	L2/mm	Min. Q.ty	€/Pz
FG 139/B1.5	1.5	46.5	15.5	5pz	<b>0,40</b>
FG 139/B2	2.0	52.0	18.0	5pz	<b>0,40</b>
FG 139/B2.5	2.5	58.5	20.5	5pz	<b>0,50</b>
FG 139/B3	3.0	66.0	23.0	5pz	<b>0,50</b>
FG 139/B4	4.0	74.0	29.0	5pz	<b>0,60</b>
FG 139/B4.5	4.5	80.0	30.5	5pz	<b>0,60</b>
FG 139/B5	5.0	85.0	33.0	5pz	<b>0,70</b>
FG 139/B5.5	5.5	90.5	35.5	5pz	<b>0,70</b>
FG 139/B6	6.0	96.0	38.0	5pz	<b>1,30</b>
FG 139/B7	7.0	102.0	41.0	5pz	<b>1,60</b>
FG 139/B8	8.0	108.0	44.0	5pz	<b>1,70</b>
FG 139/B9	9.0	111.0	46.0	5pz	<b>2,10</b>
FG 139/B10	10.0	122.0	50.0	5pz	<b>2,60</b>

CODE	mm	L1/mm	L2/mm	Min. Q.ty	€/Pz
FG 139/B11	11.0	126.0	52.0	5pz	<b>3,80</b>
FG 139/B12	12.0	137.0	57.0	2pz	<b>5,50</b>
FG 139/B13	13.0	142.0	62.0	2pz	<b>5,60</b>
FG 139/B14	14.0	154.0	70.0	2pz	<b>8,00</b>
FG 139/B16	16.0	165.0	75.0	2pz	<b>9,00</b>
FG 139/B17	17.0	177.0	80.0	2pz	<b>12,50</b>
FG 139/B19	19.0	199.0	89.0	2pz	<b>17,50</b>
FG 139/B22	22.0	216.0	100.0	2pz	<b>27,00</b>
FG 139/B24	24.0	242.0	112.0	1pz	<b>32,00</b>
FG 139/B27	27.0	271.0	125.0	1pz	<b>42,00</b>
FG 139/B30	30.0	309.0	140.0	1pz	<b>65,00</b>
FG 139/B32	30.0	341.0	155	1pz	<b>90,00</b>
FG 139/B36	36.0	385.0	174.0	1pz	<b>120,00</b>

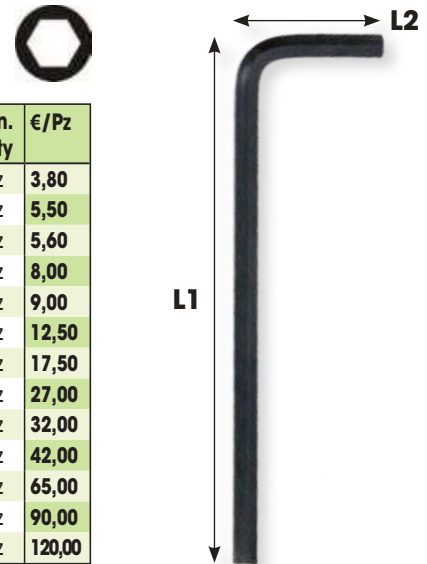

## Offset hexagon key wrenches - long series

CODE	mm	L1/mm	L2/mm	Min. Q.ty	€/Pz
FG 139/C1.5	1.5	63.5	15.5	5pz	<b>0,80</b>
FG 139/C2	2.0	77.0	18.0	5pz	<b>0,90</b>
FG 139/C2.5	2.5	87.5	20.5	5pz	<b>1,00</b>
FG 139/C3	3.0	93.0	23.0	5pz	<b>1,10</b>
FG 139/C4	4.0	104.0	29.0	5pz	<b>1,40</b>
FG 139/C4.5	4.5	114.5	30.5	5pz	<b>1,60</b>
FG 139/C5	5.0	120.0	33.0	5pz	<b>1,60</b>
FG 139/C5.5	5.5	134.0	35.5	5pz	<b>1,70</b>
FG 139/C6	6.0	141.0	38.0	5pz	<b>2,10</b>
FG 139/C7	7.0	147.0	41.0	5pz	<b>2,60</b>
FG 139/C8	8.0	158.0	44.0	5pz	<b>3,20</b>
FG 139/C10	10.0	180.0	50.0	5pz	<b>5,20</b>
FG 139/C12	12.0	202.0	57.00	2pz	<b>6,80</b>
FG 139/C14	14.0	229.0	70.0	2pz	<b>9,50</b>
FG 139/C17	17.0	262.0	80.0	2pz	<b>17,50</b>
FG 139/C19	19.0	289.0	89.0	2pz	<b>17,80</b>



**Set of 10 offset hex key wrenches**

CODE	€/Pz
FG 139/C	<b>23,00</b>

1.5,2,2.5,3,4,5,5.5,6,8,10mm



**Set of 6 offset hex key wrenches**

CODE	€/Pz
FG 139B/S6	<b>9,00</b>

2.5, 3, 4, 5, 6, 8mm



**Set of 10 offset hex key wrenches**

CODE	€/Pz
FG 139/B	<b>16,00</b>

1.5,2,2.5,3,4,5,5.5,6,8,10mm



**Set of 10 offset hex key wrenches**

CODE	€/Pz
FG 139/LM	<b>50,00</b>

1.5, 2, 2.5, 3, 4, 5, 6, 7, 8, 10mm

*Magnetic tips*



### Offset hexagon key wrenches with ball heads - short series

CODE	mm	L1/mm	L2/mm	Min. Q.ty	€/Pz
FG 139/1.5	1.5	77.0	14.0	5pz	1,40
FG 139/2	2.0	83.0	16.0	5pz	1,50
FG 139/2.5	2.5	90.0	18.0	5pz	1,50
FG 139/3	3.0	98.0	20.0	5pz	1,50
FG 139/4	4.0	106.0	24.0	5pz	1,70
FG 139/4.5	4.5	112.0	26.0	5pz	2,00
FG 139/5	5.0	118.0	28.0	5pz	2,00
FG 139/5.5	5.5	128.0	30.0	5pz	2,80
FG 139/6	6.0	137.0	32.0	5pz	2,80
FG 139/7	7.0	147.0	34.0	5pz	3,80
FG 139/8	8.0	156.0	36.0	5pz	4,90
FG 139/10	10.0	170.0	40.0	5pz	5,80

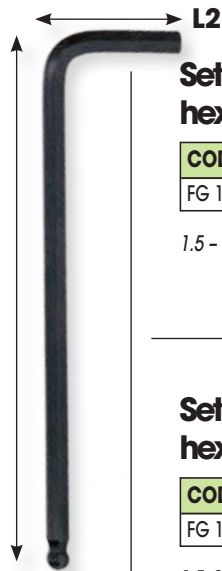

#### Set of 12 offset hex key wrenches

CODE	€/Pz
FG 139	36,00

1.5 - 10.0mm



#### Set of 8 offset hex key wrenches

CODE	€/Pz
FG 139C/FS	24,00

1.5, 2, 2.5, 3, 4, 5, 6, 8mm



### Offset hexagon key wrenches with ball heads - long series

CODE	mm	L1/mm	L2/mm	Min. Q.ty	€/Pz
FG 139/L1.5	1.5	90.0	14.0	5pz	2,00
FG 139/L2	2.0	100.0	16.0	5pz	2,00
FG 139/L2.5	2.5	112.0	18.0	5pz	2,10
FG 139/L3	3.0	125.0	20.0	5pz	2,30
FG 139/L4	4.0	140.0	24.0	5pz	2,90
FG 139/L4.5	4.5	112.0	26.0	5pz	2,90
FG 139/L5	5.0	158.0	28.0	5pz	2,90
FG 139/L5.5	5.5	168.0	30.0	5pz	3,60
FG 139/L6	6.0	178.0	32.0	5pz	3,80
FG 139/L7	7.0	188.0	34.0	5pz	4,00
FG 139/L8	8.0	200.0	36.0	5pz	5,90
FG 139/L10	10.0	224.0	40.0	5pz	7,80
FG 139/L12	12.0	224.0	40.0	5pz	12,10
FG 139/L14	14.0	240.0	50.0	5pz	19,50
FG 139/L17	17.0	260.0	55.0	5pz	25,50
FG 139/L19	19.0	285.0	75.0	5pz	23,90

L1

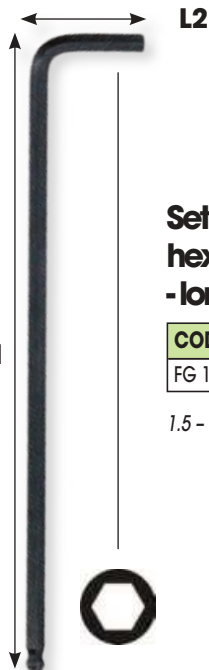

#### Set of 12 offset hex key wrenches - long series

CODE	€/Pz
FG 139/L	40,00

1.5 - 10.0mm



### Offset hexagon key wrenches with ball heads - inch series

CODE	mm	L1/mm	L2/mm	Min. Q.ty	€/Pz
FG 139IN/0.05	0.05	72.0	12.0	5	0,90
FG 139IN5/64	5/64"	77.0	14.0	5	1,10
FG 139IN3/32	3/32"	82.0	15.0	5	1,20
FG 139IN7/64	7/64"	88.0	17.0	5	1,30
FG 139IN1/8	1/8"	92.0	18.0	5	1,30
FG 139IN9/64	9/64"	96.0	19.0	5	1,50
FG 139IN5/32	5/32"	101.0	20.0	5	1,50
FG 139IN1/6	1/6"	105.0	21.0	5	1,60
FG 139IN3/16	3/16"	114.0	24.0	5	1,60
FG 139IN7/32	7/32"	124.0	26.0	5	1,80
FG 139IN1/4	1/4"	135.0	28.0	5	2,00
FG 139IN5/16	5/16"	151.0	32.0	5	2,50
FG 139IN3/8	3/8"	170.0	35.0	5	3,00

L1



#### Set of 13 offset hex key wrenches

CODE	€/Pz
FG 139/IN	38,00

0.05 - 3/8"



#### Set of 9 offset hex key wrenches

CODE	€/Pz
FG 139FS/IN	24,00

5/64, 3/32, 7/64, 1/8, 9/64, 5/32, 3/16, 7/32, 1/4"



## Offset Torx key wrenches - short series

CODE	mm	L1/mm	L2/mm	Min. Q.ty	€/Pz
FG 138/TX7	7	80.0	16.0	5pz	4,00
FG 138/TX8	8	80.0	16.0	5pz	4,00
FG 138/TX9	9	80.0	16.0	5pz	4,00
FG 138/TX10	10	86.0	17.0	5pz	4,10
FG 138/TX15	15	90.0	18.0	5pz	4,10
FG 138/TX20	20	95.0	19.0	5pz	4,10
FG 138/TX25	25	100.0	20.0	5pz	4,30
FG 138/TX27	27	105.0	22.0	5pz	4,40
FG 138/TX30	30	114.0	24.0	5pz	5,00
FG 138/TX40	40	124.0	26.0	5pz	5,40
FG 138/TX45	45.0	133.0	29.0	5pz	7,50
FG 138/TX50	50	152.0	32.0	5pz	7,90

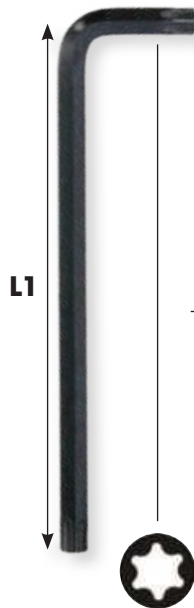

### Set of 12 offset Torx key wrenches

CODE	€/Pz
FG 138	55,00

TX7,8,9,10,15,20,25,27,30,40,45,50



### Set of 8 offset Torx key wrenches

CODE	€/Pz
FG 138C/FS	30,00

TX9 - TX40



### Set of 6 offset Torx key wrenches

TX8 - TX40

CODE	€/Pz
FG 138/S9	25,00



### Set of 10 offset Torx key wrenches

CODE	€/Pz
FG 138/M	58,00

TX10 - TX50



### Set of 10 offset Torx key wrenches

CODE	CONTENT	€/Pz
FG 138/B	TX9 - TX50 - SHORT SERIES	34,00
FG 138/C	TX9 - TX50 - LONG SERIES	37,00



Magnetic tips



## Offset Torx key wrenches - ball point series

CODE	mm	L1/mm	L2/mm	Min. Q.ty	€/Pz
FG 138BP/TX8	8	80.0	16.0	5pz	4,60
FG 138BP/TX9	9	80.0	16.0	5pz	4,60
FG 138BP/TX10	10	86.0	17.0	5pz	4,70
FG 138BP/TX15	15	90.0	18.0	5pz	4,70
FG 138BP/TX20	20	95.0	19.0	5pz	4,80
FG 138BP/TX25	25	100.0	20.0	5pz	4,90
FG 138BP/TX27	27	105.0	22.0	5pz	5,00
FG 138BP/TX30	30	114.0	24.0	5pz	5,30
FG 138BP/TX40	40	124.0	26.0	5pz	6,00
FG 138BP/TX45	45.0	133.0	29.0	5pz	8,10
FG 138BP/TX50	50	152.0	32.0	5pz	8,60

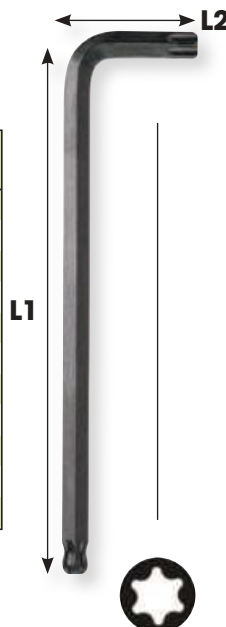

### Set of 9 offset Torx key wrenches

CODE	€/Pz
FG 138/BP	68,00

TX8,10,15,20,25,27,30,40,50

Ball head



### Offset Tamper Resistant Torx key wrenches

CODE	TX	L1/mm	L2/mm	Min. Q.ty	€/Pz
FG 137/TRX7	7	80.0	16.0	5pz	4,50
FG 137/TRX8	8	80.0	16.0	5pz	4,50
FG 137/TRX9	9	80.0	16.0	5pz	4,50
FG 137/TRX10	10	86.0	17.0	5pz	4,50
FG 137/TRX15	15	90.0	18.0	5pz	4,60
FG 137/TRX20	20	95.0	19.0	5pz	4,60
FG 137/TRX25	25	100.0	20.0	5pz	4,70
FG 137/TRX27	27	105.0	22.0	5pz	4,80
FG 137/TRX30	30	114.0	24.0	5pz	5,20
FG 137/TRX40	40	124.0	26.0	5pz	5,90
FG 137/TRX45	45	133.0	29.0	5pz	5,90
FG 137/TRX50	50	152.0	32.0	5pz	6,60

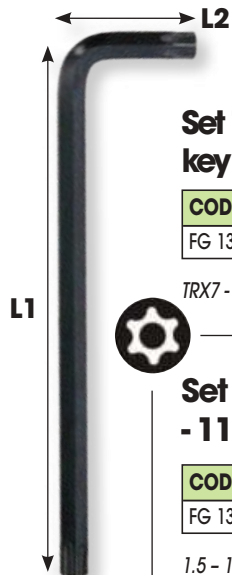

### Set 12 offset TRX key wrenches

CODE	€/Pz
FG 137	55,00

TRX7 - TRX50



### Set 09 offset hex key wrenches - 110° series with extra short arm

CODE	€/Pz
FG 139/S9	39,00

1.5 - 10.0mm



### Offset hexagon key wrenches - short series, zinc chrome plated

CODE	mm	L1/mm	L2/mm	Min. Q.ty	€/Pz
FG 139/D1.5	1.5	46.5	15.5	5pz	0,70
FG 139/D2	2.0	52.0	18.0	5pz	0,70
FG 139/D2.5	2.5	58.5	20.5	5pz	0,70
FG 139/D3	3.0	66.0	23.0	5pz	0,90
FG 139/D4	4.0	74.0	29.0	5pz	1,00
FG 139/D4.5	4.5	80.0	30.5	5pz	1,00
FG 139/D5	5.0	85.0	33.0	5pz	1,30
FG 139/D5.5	5.5	90.5	35.5	5pz	1,50
FG 139/D6	6.0	96.0	38.0	5pz	1,50
FG 139/D7	7.0	102.0	41.0	5pz	2,00
FG 139/D8	8.0	108.0	44.0	5pz	2,30
FG 139/D9	9.0	111.0	46.0	5pz	2,80
FG 139/D10	10.0	122.0	50.0	5pz	3,50

CODE	mm	L1/mm	L2/mm	Min. Q.ty	€/Pz
FG 139/D11	11.0	126.0	52.0	5pz	4,40
FG 139/D12	12.0	137.0	57.0	2pz	5,00
FG 139/D13	13.0	142.0	62.0	2pz	6,50
FG 139/D14	14.0	154.0	70.0	2pz	7,20
FG 139/D16	16.0	165.0	75.0	2pz	11,00
FG 139/D17	17.0	177.0	80.0	2pz	11,50
FG 139/D19	19.0	199.0	89.0	2pz	15,50
FG 139/D22	22.0	216.0	100.0	2pz	23,50
FG 139/D24	24.0	242.0	112.0	1pz	30,00
FG 139/D27	27.0	271.0	125.0	1pz	41,50
FG 139/D30	30.0	309.0	140.0	1pz	52,50
FG 139/D32	30.0	341.0	155	1pz	74,00
FG 139/D36	36.0	385.0	174.0	1pz	105,00

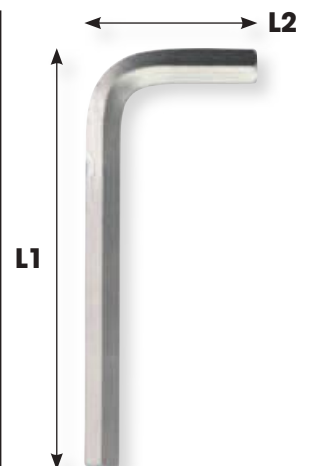

### Offset hexagon key wrenches - long series, zinc chrome plated

CODE	mm	L1/mm	L2/mm	Min. Q.ty	€/Pz
FG 139/E1.5	1.5	63.5	15.5	5pz	1,40
FG 139/E2	2.0	77.0	18.0	5pz	1,40
FG 139/E2.5	2.5	87.5	20.5	5pz	1,60
FG 139/E3	3.0	93.0	23.0	5pz	1,60
FG 139/E4	4.0	104.0	29.0	5pz	1,80
FG 139/E5	5.0	120.0	33.0	5pz	2,20
FG 139/E5.5	5.5	134.0	35.5	5pz	2,40
FG 139/E6	6.0	141.0	38.0	5pz	2,40
FG 139/E7	7.0	147.0	41.0	5pz	2,60
FG 139/E8	8.0	158.0	44.0	5pz	3,20
FG 139/E10	10.0	180.0	50.0	5pz	4,90
FG 139/E12	12.0	202.0	57.00	2pz	6,50
FG 139/E14	14.0	229.0	70.0	2pz	9,20
FG 139/E17	17.0	262.0	80.0	2pz	15,50
FG 139/E19	19.0	289.0	89.0	2pz	21,50

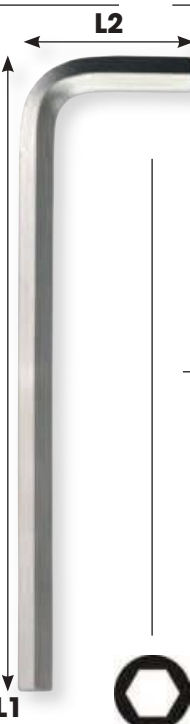

### Set of 10 offset short hex key wrenches

CODE	€/Pz
FG 139/D	21,00

1.5, 2, 2.5, 3, 4, 5, 5.5, 6, 8, 10



### Set of 10 offset long hex key wrenches

CODE	€/Pz
FG 139/E	32,00

1.5, 2, 2.5, 3, 4, 5, 5.5, 6, 8, 10



**1/4"dr. drill bits for slotted head screws - DIN 3126 - C6.3**

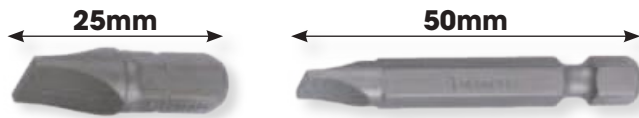

CODE	mm	Min. Q.ty	€/Pz
FG 85/25F1	0.5x3	03pz	<b>1,20</b>
FG 85/25F2	0.6x4.5	03pz	<b>1,20</b>
FG 85/25F3	0.8x5.5	03pz	<b>1,20</b>
FG 85/25F4	1x5.5	03pz	<b>1,20</b>
FG 85/25F5	1.2x6.5	03pz	<b>1,20</b>
FG 85/25F6	1.2x8	03pz	<b>2,00</b>
FG 85/25F7	1.6x8	03pz	<b>2,00</b>

CODE	mm	Min. Q.ty	€/Pz
FG 85/50F1	0.5x3	03pz	<b>3,00</b>
FG 85/50F2	0.6x4.5	03pz	<b>3,00</b>
FG 85/50F3	0.8x5.5	03pz	<b>3,00</b>
FG 85/50F4	1x5.5	03pz	<b>3,00</b>
FG 85/50F5	1.2x6.5	03pz	<b>3,00</b>
FG 85/50F6	1.2x8	03pz	<b>3,50</b>
FG 85/50F7	1.6x8	03pz	<b>3,50</b>

**1/4"dr. drill bits for Phillips head screws DIN 3126 - C6.3**

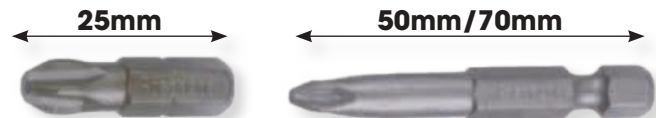

CODE	PH	Min. Q.ty	€/Pz
FG 85/25PH0	0	03pz	<b>1,60</b>
FG 85/25PH1	1	03pz	<b>1,70</b>
FG 85/25PH2	2	03pz	<b>1,70</b>
FG 85/25PH3	3	03pz	<b>1,70</b>

CODE	PH	Min. Q.ty	€/Pz
FG 85/50PH1	1	03pz	<b>3,50</b>
FG 85/70PH1	1	<b>03pz</b>	<b>5,00</b>
FG 85/50PH2	2	03pz	<b>3,50</b>
FG 85/70PH2	2	<b>03pz</b>	<b>5,00</b>
FG 85/50PH3	3	03pz	<b>3,50</b>
FG 85/70PH3	3	<b>03pz</b>	<b>5,00</b>

**1/4"dr. drill bits for Pozidriv head screws DIN 3126 - C6.3**



CODE	PZ	Min. Q.ty	€/Pz
FG 85/25Z1	1	03pz	<b>1,10</b>
FG 85/25Z2	2	03pz	<b>1,10</b>
FG 85/25Z3	3	03pz	<b>1,10</b>
FG 85/25Z4	4	03pz	<b>1,10</b>

CODE	PZ	Min. Q.ty	€/Pz
FG 85/50Z1	1	03pz	<b>3,50</b>
FG 85/50Z2	2	03pz	<b>3,50</b>
FG 85/50Z3	3	03pz	<b>3,50</b>

**1/4"dr. drill bits for Tamper Resistant Torx head screw**



CODE	PZ	Min. Q.ty	€/Pz
FG 85/25TT10	10	03pz	<b>2,10</b>
FG 85/25TT15	15	03pz	<b>2,10</b>
FG 85/25TT20	20	03pz	<b>2,10</b>
FG 85/25TT25	25	03pz	<b>2,10</b>
FG 85/25TT27	27	03pz	<b>2,10</b>
FG 85/25TT30	30	03pz	<b>2,10</b>
FG 85/25TT40	40	03pz	<b>2,10</b>

**1/4"dr. drill bits for XZN head screws DIN 3126 - C6.3**

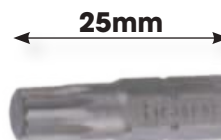

CODE	PZ	Min. Q.ty	€/Pz
FG 85/25M4	4	03pz	<b>1,10</b>
FG 85/25M5	5	03pz	<b>1,10</b>
FG 85/25M6	6	03pz	<b>1,10</b>
FG 85/25M10	10	03pz	<b>1,10</b>

**1/4"dr. drill bits for hex head screws DIN 3126 - C6.3**

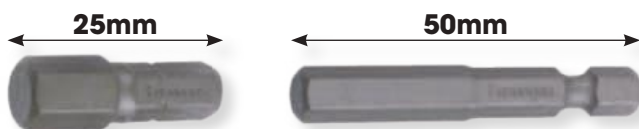

CODE	mm	Min. Q.ty	€/Pz
FG 85/25H1.5	1.5	03pz	<b>1,30</b>
FG 85/25H2	2	03pz	<b>1,30</b>
FG 85/25H2.5	2.5	03pz	<b>1,30</b>
FG 85/25H3	3	03pz	<b>1,30</b>
FG 85/25H4	4	03pz	<b>1,30</b>
FG 85/25H5	5	03pz	<b>1,30</b>
FG 85/25H6	6	03pz	<b>1,30</b>
FG 85/25H7	7	03pz	<b>1,70</b>
FG 85/25H8	8	03pz	<b>1,70</b>
FG 85/25H10	10	03pz	<b>2,20</b>

CODE	mm	Q.tà min.	€/Pz
FG 85/50H2	2	03pz	<b>3,30</b>
FG 85/50H2.5	2.5	03pz	<b>3,30</b>
FG 85/50H3	3	03pz	<b>3,30</b>
FG 85/50H4	4	03pz	<b>3,30</b>
FG 85/50H5	5	03pz	<b>4,00</b>
FG 85/50H6	6	03pz	<b>4,00</b>
FG 85/50H7	7	03pz	<b>4,00</b>
FG 85/50H8	8	03pz	<b>3,70</b>
FG 85/50H10	10	03pz	<b>3,70</b>

**1/4"dr. drill bits for Torx head screws DIN 3126 - C6.3**

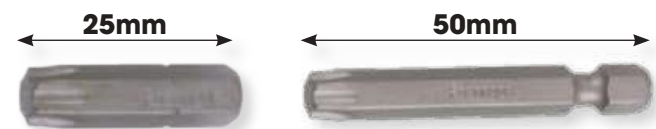

CODE	PZ	Min. Q.ty	€/Pz
FG 85/25T9	9	03pz	<b>1,70</b>
FG 85/25T10	10	03pz	<b>1,70</b>
FG 85/25T15	15	03pz	<b>1,70</b>
FG 85/25T20	20	03pz	<b>1,70</b>
FG 85/25T25	25	03pz	<b>1,70</b>
FG 85/25T27	27	03pz	<b>1,70</b>
FG 85/25T30	30	03pz	<b>1,70</b>
FG 85/25T40	40	03pz	<b>1,70</b>
FG 85/25T45	45	03pz	<b>1,90</b>
FG 85/25T50	50	03pz	<b>2,10</b>

CODE	PZ	Min. Q.ty	€/Pz
FG 85/50T9	9	03pz	<b>4,20</b>
FG 85/50T10	10	03pz	<b>4,20</b>
FG 85/50T15	15	03pz	<b>4,20</b>
FG 85/50T20	20	03pz	<b>4,20</b>
FG 85/50T25	25	03pz	<b>4,20</b>
FG 85/50T27	27	03pz	<b>4,20</b>
FG 85/50T30	30	03pz	<b>4,20</b>
FG 85/50T40	40	03pz	<b>4,20</b>
FG 85/50T45	45	03pz	<b>5,20</b>
FG 85/50T50	50	03pz	<b>5,20</b>



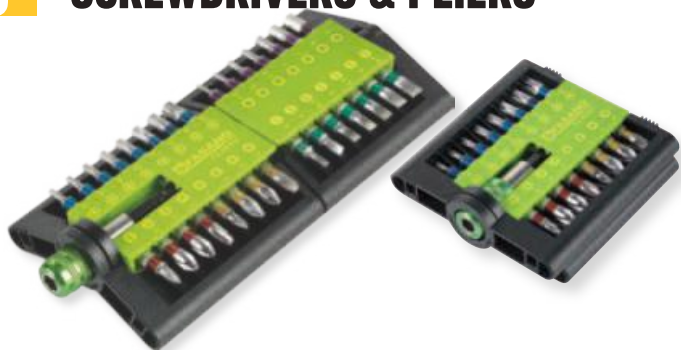

### Set 31 1/4"dr. bits + bit holder

CODE	CONTENT	€/Pz
FG 85/S31	FG 88/60PI3	65,00
	FG 85/25PH1, PH2, PH3	
	FG 85/25SL3, SL4, SL4.5, SL5, SL5.5, SL6, SL6.5	
	FG 85/25PZ1, PZ2, PZ3	
	FG 85/H1.5, H2, 2.5, H3, H4, H5, H6	
	FG 85/25T9, T10, T15, T20, T25, T27, T30, T40	



### Set of Torx bits + bit holder

CODE	€/Pz
FG 85TX/S11	32,00

FG 85/25T7,T8,T9,T10, T15, T20,  
T25, T27,T30, T40 + bitholder



### Set of bits + bit holder

CODE	€/Pz
FG 85/S11	28,00

FG 85/25PH1,PH2,PH3,  
FG 85/25PZ1,PZ2,PZ3  
FG 85/SL4, 5, 6, 7  
FG 88/60PI2



### Hexagon key wrenches with Bi-material handle

CODE	mm	€/Pz
FG 142/2	2	9,60
FG 142/2.5	2.5	10,20
FG 142/3	3	11,00
FG 142/4	4	12,20
FG 142/5	5	13,20
FG 142/6	6	15,00
FG 142/7	7	15,30
FG 142/8	8	16,50
FG 142/10	10	18,00



### Set of 9 hexagon Handle key wrenches

CODE	€/Pz
FG 142/S9	125,00

2, 2.5, 3, 4, 5, 6, 7, 8, 10 mm



### Torx key wrenches with Bi-material handle

CODE	TX	€/Pz
FG 143/TX7	7	10,20
FG 143/TX8	8	10,20
FG 143/TX9	9	10,20
FG 143/TX10	10	10,50
FG 143/TX15	15	11,00
FG 143/TX20	20	11,80
FG 143/TX25	25	12,60
FG 143/TX27	27	13,20
FG 143/TX30	30	13,90
FG 143/TX40	40	15,80
FG 143/TX45	45	18,50
FG 143/TX50	50	21,50

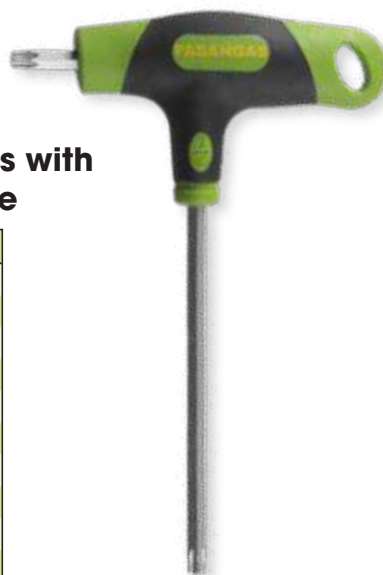

### Set of Torx Thandle key wrenches

CODE	CONTENT	€/Pz
FG 143TX/S6	TX10, TX15, TX20, TX25, TX30, TX40	80,00
FG 143TX/S12	TX7 - TX50	165,00



**1/4"dr. drill bits for slotted head screws DIN 3126 - C6.3**



CODE	mm	Min. Q.ty	€/Pz
FG 85/100F3	0.6x3	03pz	5,00
FG 85/100F4	0.8x4	03pz	5,00
FG 85/100F5.5	1.0x5.5	03pz	5,00

**1/4"dr. drill bits for Phillips screws DIN 3126 - C6.3**



CODE	PH	Min. Q.ty	€/Pz
FG 85/100PH1	1	03pz	5,40
FG 85/100PH2	2	03pz	5,40
FG 85/100PH3	3	03pz	5,40

**1/4"dr. drill bits for Pozidriv screws DIN 3126 - C6.3**



CODE	PH	Min. Q.ty	€/Pz
FG 85/100PZ1	1	03pz	5,40
FG 85/100PZ2	2	03pz	5,40
FG 85/100PZ3	3	03pz	5,40

**1/4"dr. drill bits for hex head screws DIN 3126 - C6.3**



CODE	PH	Min. Q.ty	€/Pz
FG 85/100H4	4	03pz	5,20
FG 85/100H5	5	03pz	5,20
FG 85/100H6	6	03pz	5,20

**1/4"dr. drill bits for Torx head screws DIN 3126 - C6.3**



CODE	PH	Q.tà min.	€/Pz
FG 85/100T15	15	03pz	5,40
FG 85/100T20	20	03pz	5,40
FG 85/100T25	25	03pz	5,40



**Set of extra long 1/4"dr. bits - 100mm**

CODE	CONTENT	€/Pz
FG 85/S15L	FG 85/100F3, F4, F5.5	92,00
	FG 85/100PH0, PH1, PH2, PH3	
	FG 85/100PZ1, Pz2, PZ3	
	FG 85/100H4, H5, H6	
	FG 85/100T15, T20, T25	

**Bit holder with handle**

CODE	€/Pz
FG 88/P14	24,00



**Bit holder**

CODE	● x ◊	€/Pz
FG 88/60PI1	1/4" x 1/4"	10,00
FG 88/60PI2	1/4" x 1/4"	9,00

FG 88/60PI1 - without retainer  
FG 88/60PI2 - with retainer



**Bit holder with SDS drive**

CODE	€/Pz
FG 88/100SDS	22,50



**Bit holder**

CODE	● x ◊	€/Pz
FG 88/60PI3	1/4" x 1/4"	12,50





### Bit holder with female drive

CODE	□ x ◊	L/mm	€/Pz
FG 89/38PI1	1/4" x 1/4"	32	<b>19,50</b>
FG 89/50PI2	3/8" x 1/4"	50	<b>22,50</b>
FG 89/50PI3	3/8" x 5/16"	50	<b>23,00</b>
FG 89/55PI4	1/2" x 1/4"	55	<b>26,00</b>
FG 89/55PI5	1/2" x 5/16"	55	<b>28,00</b>



### Socket holder for drill

CODE	□ x ◊	L/mm	€/Pz
FG 88/75PB1	1/4" x 1/4"	75	<b>16,50</b>
FG 85/75PB2	1/4" x 3/8"	75	<b>19,50</b>
FG 85/75PB3	1/4" x 1/2"	75	<b>22,50</b>



### 10mm drill bits for hex head screws DIN 3126 - C6.3



CODE	mm	Min. Q.ty	€/Pz	CODE	mm	Min. Q.ty	€/Pz
FG 86/30H4	4	03pz	<b>1,60</b>	FG 86/75H4	4	03pz	<b>3,00</b>
FG 86/30H5	5	03pz	<b>1,60</b>	FG 86/75H5	5	03pz	<b>3,00</b>
FG 86/30H6	6	03pz	<b>1,60</b>	FG 86/75H6	6	03pz	<b>3,00</b>
FG 86/30H7	7	03pz	<b>1,60</b>	FG 86/75H7	7	03pz	<b>3,00</b>
FG 86/30H8	8	03pz	<b>1,60</b>	FG 86/75H8	8	03pz	<b>3,00</b>
FG 86/30H10	10	03pz	<b>1,60</b>	FG 86/75H10	10	03pz	<b>3,00</b>
FG 86/30H12	12	03pz	<b>2,50</b>	FG 86/75H12	12	03pz	<b>4,00</b>
FG 86/30H14	14	03pz	<b>3,40</b>	FG 86/75H14	14	03pz	<b>5,50</b>

### Inserto per viti con testa Torx DIN 3126 - C6.3



CODE	TX	Min. Q.ty	€/Pz	CODE	TX	Min. Q.ty	€/Pz
FG 86/30T20	20	03pz	<b>1,60</b>	FG 86/75T20	20	03pz	<b>2,70</b>
FG 86/30T25	25	03pz	<b>1,60</b>	FG 86/75T25	25	03pz	<b>2,70</b>
FG 86/30T27	27	03pz	<b>1,60</b>	FG 86/75T27	27	03pz	<b>2,70</b>
FG 86/30T30	30	03pz	<b>1,60</b>	FG 86/75T30	30	03pz	<b>2,70</b>
FG 86/30T40	40	03pz	<b>1,60</b>	FG 86/75T40	40	03pz	<b>2,70</b>
FG 86/30T45	45	03pz	<b>1,60</b>	FG 86/75T45	45	03pz	<b>2,70</b>
FG 86/30T50	50	03pz	<b>1,60</b>	FG 86/75T50	50	03pz	<b>2,70</b>
FG 86/30T55	55	03pz	<b>1,60</b>	FG 86/75T55	55	03pz	<b>2,70</b>

### 10mm drill bits for Tamper Torx Resistant head screws



CODE	RTX	Min. Q.ty	€/Pz	CODE	RTX	Min. Q.ty	€/Pz
FG 86/30TT20	20	03pz	<b>1,70</b>	FG 86/75TT20	20	03pz	<b>3,00</b>
FG 86/30TT25	25	03pz	<b>1,70</b>	FG 86/75TT25	25	03pz	<b>3,00</b>
FG 86/30TT27	27	03pz	<b>1,70</b>	FG 86/75TT27	27	03pz	<b>3,00</b>
FG 86/30TT30	30	03pz	<b>1,70</b>	FG 86/75TT30	30	03pz	<b>3,00</b>
FG 86/30TT40	40	03pz	<b>1,70</b>	FG 86/75TT40	40	03pz	<b>3,00</b>
FG 86/30TT45	45	03pz	<b>1,70</b>	FG 86/75TT45	45	03pz	<b>3,00</b>
FG 86/30TT50	50	03pz	<b>1,70</b>	FG 86/75TT50	50	03pz	<b>3,00</b>
FG 86/30TT55	55	03pz	<b>1,70</b>	FG 86/75TT55	55	03pz	<b>3,00</b>

### 10mm drill bits for XZN head screws DIN 3126 - C6.3

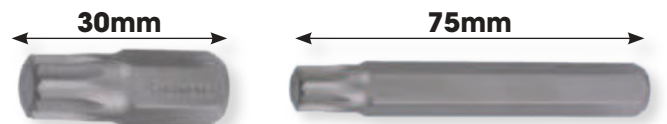

CODE	TX	Min. Q.ty	€/Pz	CODE	TX	Min. Q.ty	€/Pz
FG 86/30M5	5	03pz	<b>2,00</b>	FG 86/75M5	5	03pz	<b>3,50</b>
FG 86/30M6	6	03pz	<b>2,00</b>	FG 86/75M6	6	03pz	<b>3,50</b>
FG 86/30M8	8	03pz	<b>2,00</b>	FG 86/75M8	8	03pz	<b>3,50</b>
FG 86/30M10	10	03pz	<b>2,00</b>	FG 86/75M10	10	03pz	<b>3,60</b>
FG 86/30M12	12	03pz	<b>2,90</b>	FG 86/75M12	12	03pz	<b>3,90</b>
FG 86/30M14	14	03pz	<b>3,40</b>				

### Adaptor - 1/2" x 10mm

CODE	€/Pz
FG 86/AD2	<b>5,50</b>





**Set of 28 bits with 10mm drive + bit holder**

CODE	CONTENT	€/Pz
FG 86/S30B	FG 86/30TT10- T40, FG 86/75TT10 - T40	82,00
	FG 86/30TT10- TT40, FG 86/75TT4 - TT40	
	ADATTATORE PORTA INSERTI 1/2" x 10mm	

CODE	CONTENT	€/Pz
FG 86/S30	FG 86/30TT10- T40, FG 86/75TT10 - T40	82,00
	FG 86/30H4,5,6 - FG 86/75H4,5,6	
	FG 86/30M4-M10 - FG 86/75M4-M10	
	2 ADATTATORI PORTA INSERTI 1/2" x 10mm	

5/16"

**Drill bits for slotted head screws**

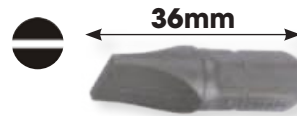

CODE	mm	Min. Q.ty	€/Pz
FG 87/25F1	1.2x6.0	03pz	3,70
FG 87/25F2	1.6x8.0	03pz	3,70
FG 87/25F3	1.6x10	03pz	4,20
FG 87/25F4	2.0x12	03pz	4,70

5/16"

**Inserto per viti con testa a croce Phillips**



CODE	PH	Min. Q.ty	€/Pz
FG 87/PH1	1	03pz	2,70
FG 87/PH2	2	03pz	2,70
FG 87/PH3	3	03pz	2,70
FG 87/PH4	4	03pz	2,70

5/16"

**Drill bits for Pozidriv head screws**



CODE	PZ	Min. Q.ty	€/Pz
FG 87/PZ0	0	03pz	3,50
FG 87/PZ1	1	03pz	3,50
FG 87/PZ2	2	03pz	3,50
FG 87/PZ3	3	03pz	3,50

5/16"

**Drill bits for hex head screws**



CODE	mm	Min. Q.ty	€/Pz
FG 87/H4	4	03pz	3,00
FG 87/H5	5	03pz	3,00
FG 87/H6	6	03pz	3,00
FG 87/H8	8	03pz	3,00
FG 87/H10	10	03pz	4,00

5/16"

**Drill bits for Torx head screws**

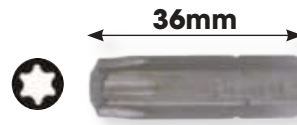

CODE	TX	Min. Q.ty	€/Pz
FG 87/TX20	20	03pz	4,00
FG 87/TX25	25	03pz	4,00
FG 87/TX27	27	03pz	4,00
FG 87/TX30	30	03pz	4,00
FG 87/TX40	40	03pz	4,00
FG 87/TX45	45	03pz	4,00
FG 87/TX50	50	03pz	6,00
FG 87/TX55	55	03pz	6,00

**Adaptor - 1/2" x 5/16"**

CODE	€/Pz
FG 87/AD	6,50



**Impact screwdriver**

CODE	□	€/Pz
FG 23/1	1/2"	42,00



**Set of 28pcs impact tools**

CODE	€/Pz
FG 23/S28	150,00



20+ ITEMS

CUTTING  
EDGE

HRC 63

NEW

CUTTING CAPACITY 6mm\*

the figure refers to the maximum value covered by the range

POLISHED FINISH

## SYMBOL TYPE OF WIRE - EXAMPLE



SOFT WIRE mm - COPPER, ALUMINUM



MEDIUM HARD WIRE mm - IRON WIRE



HARD WIRE mm - STEEL WIRE



PIANO WIRE mm - HARDENED SPRING STEEL



HIGH LEVERAGE

For minimal strain during use



NEW INDUSTRIAL PLIERS

## INDUSTRIAL SERIES

## Combination pliers

bimaterial handles

INDUSTRIAL - DIN ISO 5746



NEW

CODE	mm/inch	○	◐	◑	●	HRC	€/Pz
FG 59/XT160	160 - 6"	4	2,8	1,8	1,4	58-63	22,00
FG 59/XT180	180 - 7"	4	3	2	1,6	58-63	27,00
FG 59/XT200	200 - 8"	4	3	2	1,6	58-63	31,00

## Combination pliers

High Leverage model

bimaterial handles

INDUSTRIAL - DIN ISO 5746



NEW

CODE	mm/inch	○	◐	◑	●	HRC	€/Pz
FG 59/HL160	160 - 6"	4	2,8	1,8	1,4	58-63	26,00
FG 59/HL180	180 - 7"	4	2,8	1,8	1,6	58-63	29,00
FG 59/HL200	200 - 8"	5	3,5	2,4	2	58-63	34,00
FG 59/HL250	250 - 9"	6	4	2,8	2,4	58-63	36,00

## Bent nose pliers

bimaterial handles

INDUSTRIAL - DIN ISO 5745



NEW

CODE	mm/inch	○	◐	◑	●	HRC	€/Pz
FG 60/XT160	160 - 6"	4	2,8	1,8	1,4	58-63	30,00
FG 60/XT200	200 - 8"	4	3	2	1,6	58-63	34,00

## Long nose pliers

bimaterial handles

INDUSTRIAL - DIN ISO 5745



NEW

CODE	mm/inch	○	◐	◑	●	HRC	€/Pz
FG 61/XT160	160 - 6"	4	2,8	1,8	1,4	58-63	26,00
FG 61/XT200	200 - 8"	4	3	2	1,6	58-63	31,00

**Pinza becchi piatti**  
bimaterial handles  
INDUSTRIAL - DIN ISO 5745



**NEW**

CODE	mm/inch	€/Pz
FG 62/XT160	160 - 6"	<b>28,00</b>

**Flat nose pliers**  
bimaterial handles  
INDUSTRIAL - DIN ISO 5749



**NEW**

CODE	mm/inch	○	◐	◑	●	HRC	€/Pz
FG 63/XT140	140 - 5"	3	2	1,6	1,2	58-63	<b>28,00</b>
FG 63/XT160	160 - 6"	4	2,5	2	1,6	58-63	<b>30,00</b>

**Diagonal cutting pliers,**  
with stripping hoses  
1.5 e 2.5mm  
High Leverage model  
bimaterial handles  
INDUSTRIAL - DIN ISO 5749



**NEW**

CODE	mm/inch	○	◐	◑	●	HRC	€/Pz
FG 63/HL180	160 - 6"	Capacità mm <sup>2</sup> 1,5+2,5			58-63	<b>46,00</b>	

**Heavy Duty diagonal cutting pliers**  
bimaterial handles  
INDUSTRIAL - DIN ISO 5749



**NEW**

CODE	mm/inch	○	◐	◑	●	HRC	€/Pz
FG 63/H160	160 - 6"	4	3	2	1,6	58-63	<b>32,00</b>
FG 63/H180	180 - 7"	5	3,5	2,4	2	58-63	<b>34,00</b>
FG 63/H200	200 - 8"	5	3,5	2,4	2	58-63	<b>38,00</b>

**End cutting pliers**  
bimaterial handles  
INDUSTRIAL



**NEW**

CODE	mm/inch	○	◐	◑	●	HRC	€/Pz
FG 64/XT160	160 - 6"	4	3	2	1,6	58-63	<b>35,00</b>
FG 64/XT200	200 - 8"	5	3,5	2,4	2	58-63	<b>42,00</b>

**Round nose pliers**  
bimaterial handles  
INDUSTRIAL - DIN ISO 5749



**NEW**

CODE	mm/inch	€/Pz
FG 65/XT160	160 - 6"	<b>27,00</b>

**Set of 3pcs pliers**

CODE	CONTENUTO	€/Pz
FG 59XT/S3	FG 59/XT180, FG 63/XT160, FG 61/XT160	<b>85,00</b>
FG 59XT/S3B	FG 63/H180, FG 61/XT200, FG 59/XT180	<b>95,00</b>

**NEW**



## SOFT RUN SERIES

### Combination pliers

bimaterial handles  
SOFT RUN - DIN ISO 5746



CODE	mm/inch	○	◐	◑	●	HRC	€/Pz
FG 59SR/160	160 - 6"		3,1	2		58	20,50
FG 59SR/180	180 - 7"		3,4	2,2		58	28,00
FG 59SR/200	200 - 8"		3,8	2,5		58	28,00

### Bent nose pliers

bimaterial handles  
SOFT RUN - DIN ISO 5745



CODE	mm/inch	○	◐	◑	●	HRC	€/Pz
FG 60SR/160	160 - 6"		2,5	1,6		58	26,00
FG 60SR/200	200 - 8"		3,2	2,2		58	31,50

### Long nose pliers

bimaterial handles  
SOFT RUN - DIN ISO 5745



CODE	mm/inch	○	◐	◑	●	HRC	€/Pz
FG 61SR/200	200 - 8"		3,2	2,2		58	27,00

### Flat nose pliers

bimaterial handles  
SOFT RUN - DIN ISO 5745



CODE	mm/inch	HRC	€/Pz
FG 62SR/160	160 - 6"	58	24,00

### Diagonal cutting pliers

bimaterial handles  
SOFT RUN - DIN ISO 5749



CODE	mm/inch	○	◐	◑	●	HRC	€/Pz
FG 63SR/160	160 - 6"	4	2,8	2		58	26,00

### Diagonal cutting pliers, Heavy-Duty model

bimaterial handles  
SOFT RUN - DIN ISO 5749



CODE	mm/inch	○	◐	◑	●	HRC	€/Pz
FG 63SR/H180	180 - 7"		3,8	2,7		58	30,00
FG 63SR/H200	200 - 8"		4,2	3		58	33,00

### Wire stripping pliers

bimaterial handles  
DIN ISO 8979



CODE	mm/inch	max mm <sup>2</sup>	€/Pz
FG 68SR/160	160 - 6"	10	30,00

### End cutting pliers

bimaterial handles  
DIN ISO 9242



CODE	mm/inch	HRC	€/Pz
FG 64SR/220	220 - 9"	58	29,15
FG 64SR/280	280 - 11"	58	35,51



### Set of 3pcs pliers

CODE	CONTENUTO	€/Pz
FG 59SR/S3	FG 59SR/160, FG 60SR/160, FG 63SR/H200	82,00
FG 59SR/S3B	FG 59SR/200, FG 61SR/200, FG 63SR/H200	92,00

# PVC SERIES

## Combination pliers

PVC handles  
DIN ISO 5746

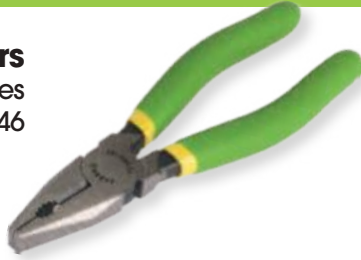

CODE	mm/inch	○	◐	◑	●	HRC	€/Pz
FG 59PV/160	160 - 6"	4	2,8	1,8	1,4	58-63	<b>19,50</b>
FG 59PV/180	180 - 7"	4	3	2	1,6	58-63	<b>21,00</b>
FG 59PV/200	200 - 8"	4	3	2	1,6	58-63	<b>24,00</b>

## Bent nose pliers

PVC handles  
DIN ISO 5749



CODE	mm/inch	○	◐	◑	●	HRC	€/Pz
FG 60PV/160	160 - 6"		2,5	1,6		58-63	<b>22,50</b>
FG 60PV/200	200 - 8"		3,2	2,2		58-63	<b>26,50</b>

## Long nose pliers

PVC handles  
DIN ISO 5745



CODE	mm/inch	○	◐	◑	●	HRC	€/Pz
FG 61PV/160	160 - 6"	3	2	1,6	1,2	58-63	<b>21,50</b>
FG 61PV/200	200 - 8"	4	2,5	2	1,6	58-63	<b>23,50</b>

## Flat nose pliers

PVC handles  
DIN ISO 5745



CODE	mm/inch	€/Pz
FG 62PV/160	160 - 6"	<b>21,00</b>

## Diagonal cutting pliers

PVC handles  
DIN ISO 5749



CODE	mm/inch	○	◐	◑	●	HRC	€/Pz
FG 63PV/140	140 - 5"	4	2,8	1,8	1,4	58-63	<b>20,50</b>
FG 63PV/160	160 - 6"	4	3	2	1,6	58-63	<b>22,50</b>

## End cutting pliers

PVC handles  
DIN ISO 5749



CODE	mm/inch	○	◐	◑	●	HRC	€/Pz
FG 63PV/H180	180 - 7"	5	3,5	2,4	2	58-63	<b>28,00</b>
FG 63PV/H200	200 - 8"	5	3,5	2,4	2	58-63	<b>29,00</b>

## Frontal cutting pliers

PVC handles  
DIN ISO 5748



CODE	mm/inch	○	◐	◑	●	HRC	€/Pz
FG 64PV/160	160 - 6"	4	3	2	1,6	56-61	<b>26,00</b>
FG 64PV/200	200 - 8"	5	3,5	2,4	2	58-61	<b>32,00</b>

## End cutting pliers

PVC handles



CODE	mm/inch	○	◐	◑	HRC	€/Pz
FG 65PV/220	220 - 9"	4	3	2	56-61	<b>24,00</b>
FG 65PV/250	250 - 10"	4	3	2	58-61	<b>26,00</b>
FG 65PV/280	280 - 11"	4	3	2	56-61	<b>28,00</b>

## Set of 3pcs pliers

CODE	CONTENUTO	€/Pz
FG 59PV/S3	FG 59PV/160, FG 61PV/160, FG 63PV/160	<b>68,00</b>
FG 59PV/S3B	FG 59PV/180, FG 61PV/200, FG 63PV/H180	<b>75,00</b>



## External butt-ended circlip pliers

CODE	CAPACITA'	€/Pz
FG 55/SP	30 - 100	<b>45,00</b>

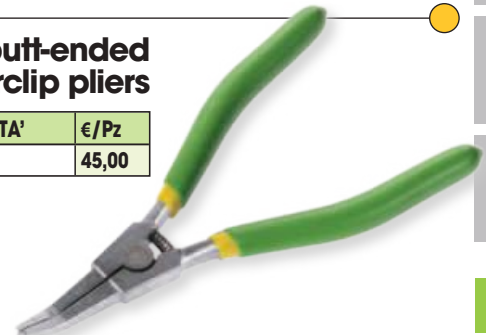



### Reversible wire twisting pliers with automatic return

CODICE	L/mm	€/Pz
FG 66/TF220	220	102,00



### Slip joint pliers boxed joints with push button alignment and slip-proof PVC handles

CODICE	mm - Inch	Posizioni	€/Pz
FG 58/A240	240 - 9.5"	5	42,00



### Slip joint pliers boxed joints with slip-proof PVC handles - DIN ISO 8976

CODICE	mm-Inch	Posizioni	€/Pz
FG 58/B180	180 - 7"	6	29,00
FG 58/B240	240 - 10"	7	33,50
FG 58/B300	300 - 12"	7	47,00
FG 58/400	400 - 16"	7	52,00

### Flat long nose pliers

CODICE	mm	€/Pz
FG 56/0	275	28,00
FG 57/0	400	38,00

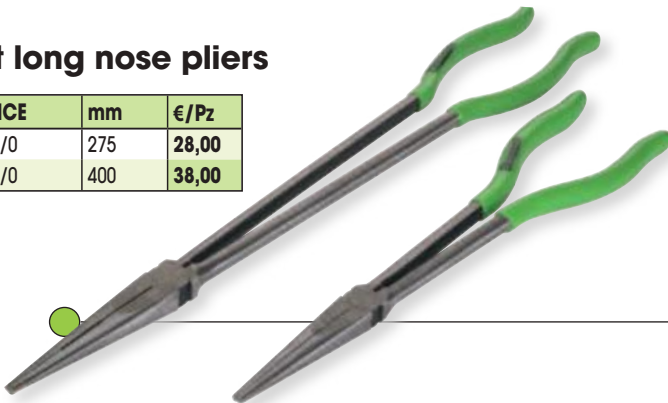

### 45° long nose pliers

CODICE	mm	€/Pz
FG 56/45	275	28,00
FG 57/45	400	38,00

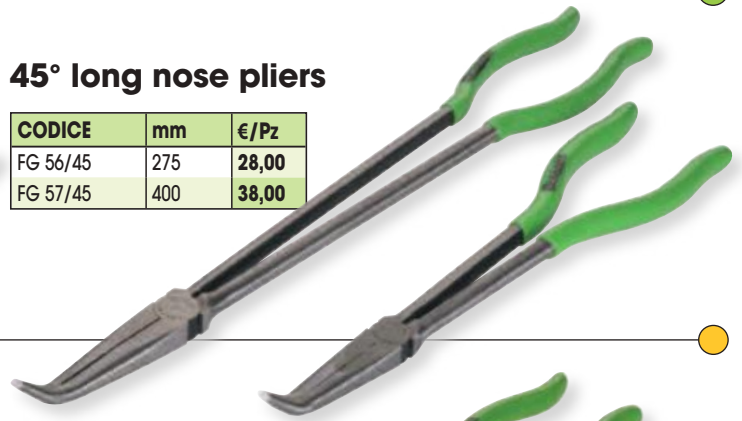

### 90° Long nose pliers°

CODICE	mm	€/Pz
FG 56/90	275	28,00
FG 57/90	400	38,00



### Set of 3pcs long nose pliers

CODICE	CONTENUTO	€/Pz
FG 56/S3	FG 56/0, FG 56/45, FG 56/90	85,00
FG 57/S3	FG 57/0, FG 57/45, FG 57/90	116,00

**Circlip pliers for outside circlips**

CODICE	L/mm	Ø/mm	€/Pz
FG 51/140	140	10-25	<b>22,00</b>
FG 51/180	180	19-60	<b>22,50</b>
FG 51/230	230	40-100	<b>31,50</b>
FG 51/310	310	85-165	<b>44,50</b>



**Circlip pliers for 90° outside circlips**

CODICE	L/mm	Ø/mm	€/Pz
FG 52/140	140	10-25	<b>23,00</b>
FG 52/180	180	19-60	<b>25,00</b>
FG 52/230	230	40-100	<b>30,50</b>
FG 52/310	310	85-165	<b>44,50</b>



**Circlip pliers for inside circlips**

CODICE	L/mm	Ø/mm	€/Pz
FG 53/140	140	12-25	<b>22,00</b>
FG 53/180	180	19-60	<b>22,50</b>
FG 53/230	230	40-100	<b>31,50</b>
FG 53/310	310	85-165	<b>44,50</b>

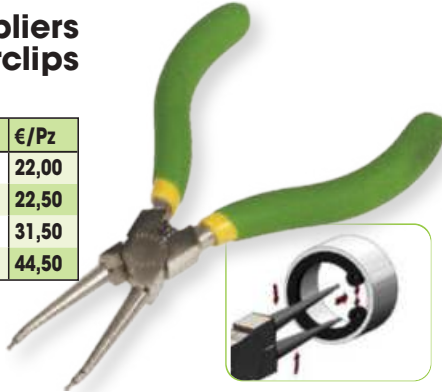

**Circlip pliers for 90° inside circlips**

CODICE	L/mm	Ø/mm	€/Pz
FG 54/140	140	12-25	<b>23,00</b>
FG 54/180	180	19-60	<b>25,00</b>
FG 54/230	230	40-100	<b>30,50</b>
FG 54/310	310	85-165	<b>44,50</b>



**Circlip pliers for outside circlips, with inserted reinforced tips**

CODICE	L/mm	Ø/mm	€/Pz
FG 55/140	140	10-25	<b>32,00</b>
FG 55/180	180	19-60	<b>33,00</b>

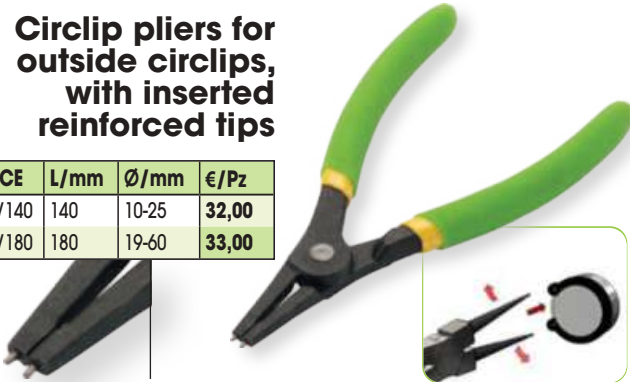

**90° Circlip pliers for outside circlips, with inserted reinforced tips**

CODICE	L/mm	Ø/mm	€/Pz
FG 56/140	140	10-25	<b>32,00</b>
FG 56/180	180	19-60	<b>33,00</b>



**Circlip pliers for inside circlips, with inserted reinforced tips**

CODICE	L/mm	Ø/mm	€/Pz
FG 57/140	140	10-25	<b>32,00</b>
FG 57/180	180	19-60	<b>33,00</b>

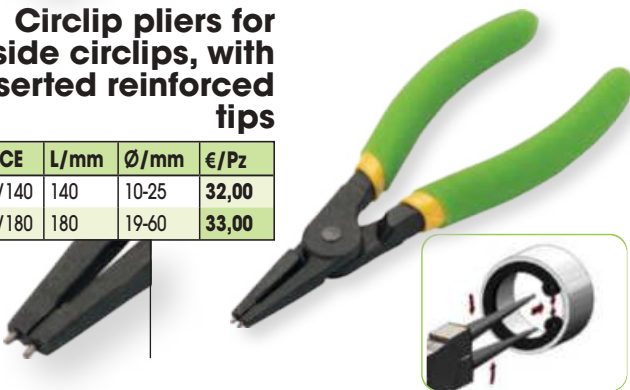

**90° Circlip pliers for inside circlips, with inserted reinforced tips**

CODICE	L/mm	Ø/mm	€/Pz
FG 58/140	140	10-25	<b>32,00</b>
FG 58/180	180	19-60	<b>33,00</b>

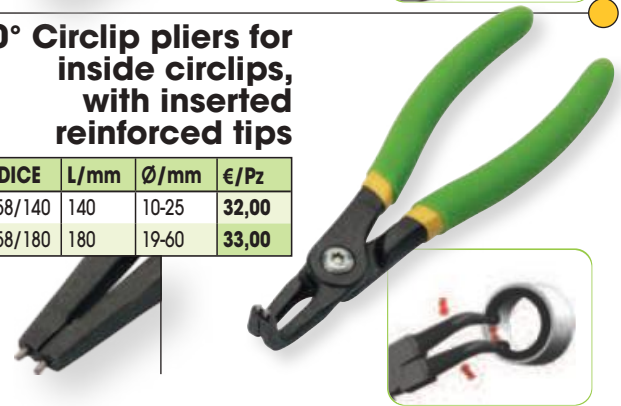

**Set of 4pcs circlip pliers**

CODICE	CONTENUTO	€/Pz
FG 51/S4	FG 51/140, FG 52/140, FG 53/140, FG 54/140	<b>95,00</b>
FG 51/S4B	FG 51/180, FG 52/180, FG 53/180, FG 54/180	<b>100,00</b>

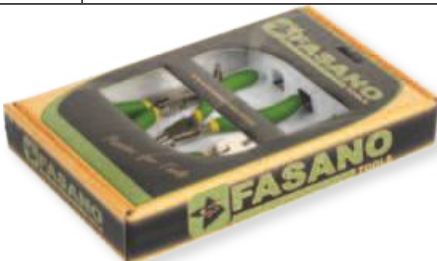

**Set of 4pcs circlip pliers, with inserted reinforced tips**

CODICE	CONTENUTO	€/Pz
FG 55/S4	FG 55/140, FG 56/140, FG 57/140, FG 58/140	<b>130,00</b>
FG 55/S4B	FG 55/180, FG 56/180, FG 57/180, FG 58/180	<b>135,00</b>





### Adjustable self-locking pliers, curve jaws

CODICE	L/mm	Max opening	€/Pz
FG 69/CJ180	180	31mm	22,50
FG 69/CJ250	250	37mm	25,00

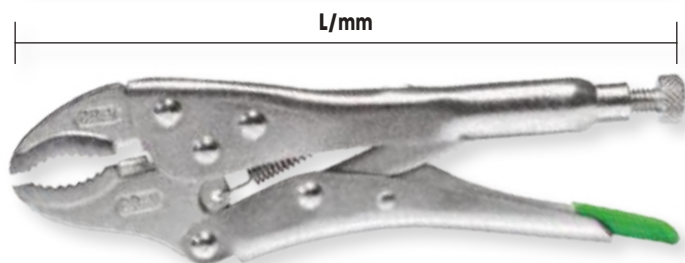

### Adjustable self-locking pliers, curve jaws

CODICE	L/mm	Max opening	€/Pz
FG 70/CJ140	140	30mm	31,00
FG 70/CJ180	180	35mm	33,00
FG 70/CJ250	250	50mm	34,50
FG 70/CJ300	300	65mm	52,00

*Superior line*

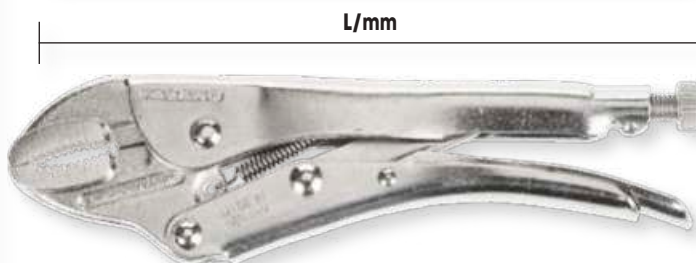

### Adjustable self-locking pliers, straight jaws

CODICE	L/mm	Max opening	€/Pz
FG 69/LN170	170	38mm	23,00
FG 69/LN230	230	65mm	27,00

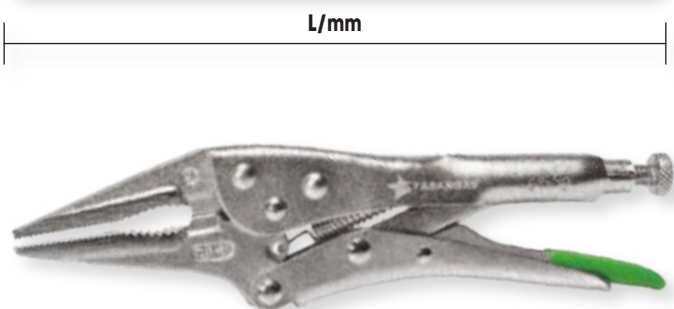

### Adjustable self-locking pliers, straight jaws

CODICE	L/mm	Max opening	€/Pz
FG 70/LN165	165	40mm	37,00
FG 70/LN240	240	55mm	39,50

*Superior line*



### Adjustable self-locking pliers, C-shaped jaws

CODICE	L/mm	Max opening	€/Pz
FG 69/CC170	170	43mm	27,00
FG 69/CC280	280	64mm	36,00
FG 69/CC460	460	255mm	51,00



### Adjustable self-locking pliers, C-shaped jaws

CODICE	L/mm	Max opening	€/Pz
FG 70/CC175	175	50mm	39,00
FG 70/CC280	280	90mm	51,00
FG 70/CC460	460	235mm	106,00

*Superior line*

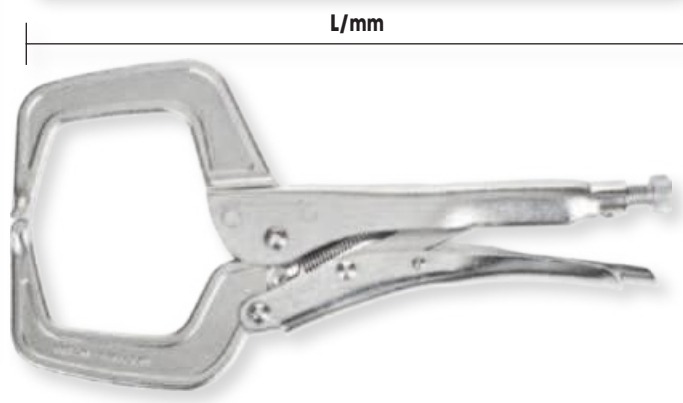

**Adjustable self-locking  
pliers, C-shaped floating jaws**

CODICE	L/mm	Max opening	€/Pz
FG 69/CP170	170	45mm	<b>33,00</b>
FG 69/CP280	280	73mm	<b>39,50</b>

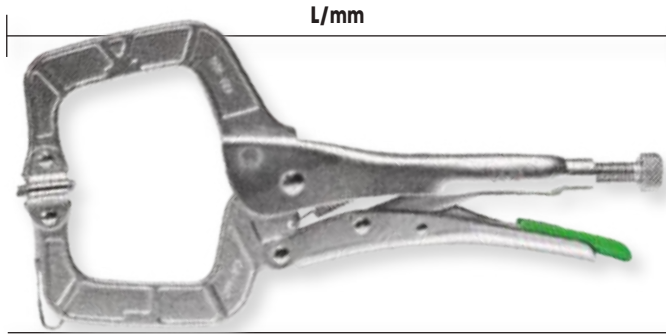

**Adjustable self-locking  
pliers, C-shaped floating jaws**

CODICE	L/mm	Max opening	€/Pz
FG 70/CP175	175	40mm	<b>58,00</b>
FG 70/CP280	280	90mm	<b>62,00</b>

*Superior line*

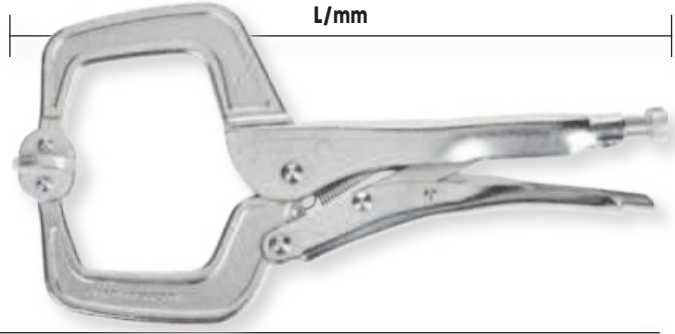

**Adjustable self-locking  
pliers, flat jaws**

CODE	L/mm	Max opening	€/Pz
FG 69/CS200	200	25mm	<b>31,00</b>



**Adjustable self-locking  
pliers, fork type jaws**

CODE	L/mm	Max opening	€/Pz
FG 69/CW225	225	25mm	<b>32,50</b>

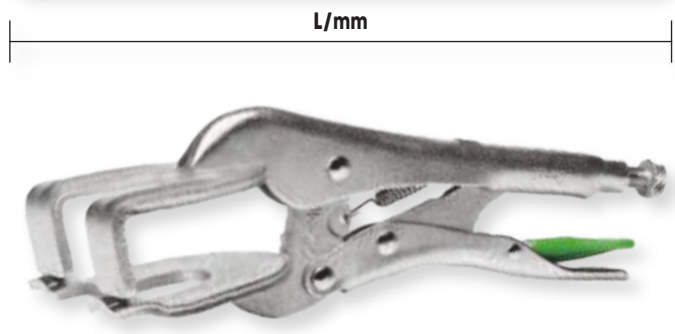

**Adjustable self-locking  
pliers, PARROT model**

CODE	L/mm	Max opening	€/Pz
FG 69/PP215	215	38mm	<b>36,00</b>



**Adjustable self-locking  
pliers with chain**

CODE	L/mm	ø/mm	€/Pz
FG 69/CH130	250	75mm	<b>41,00</b>

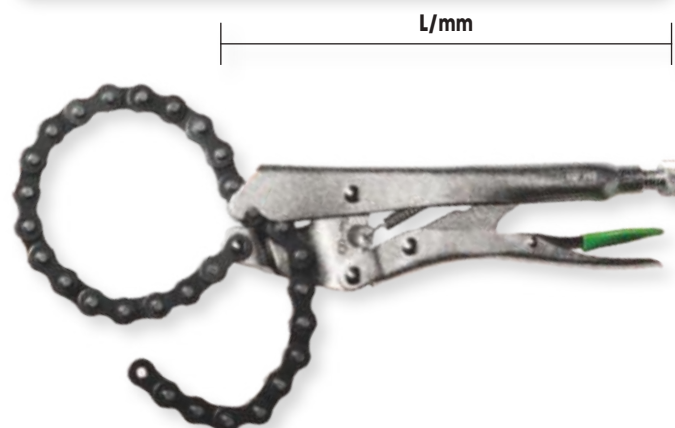



# 04

**ELECTROTECHNICS**





### Insulated simple wrench

CODE	mm	L/mm	€/Pz
FG 603/E7	7	90	22,00
FG 603/E8	8	105	22,00
FG 603/E9	9	105	23,00
FG 603/E10	10	105	24,00
FG 603/E11	11	125	25,00
FG 603/E12	12	125	25,00

CODE	mm	L/mm	€/Pz
FG 603/E13	13	155	27,00
FG 603/E14	14	155	27,00
FG 603/E16	16	170	30,00
FG 603/E17	17	170	32,00
FG 603/E18	18	180	33,00
FG 603/E19	19	180	34,00



### Set of insulated wrenches

CODE	CONTENT	€/Pz
FG 603/SP6	8,10,13,14,17,19mm	170,00
FG 603/SP9	8,10,11,12,13,14,16,17,19mm	250,00
FG 603/SP11	8,9,10,11,12,13,14,16,17,18,19mm	300,00



### Set of 12 insulated wrenches

CODE	CONTENT	€/Pz
FG 603/SC12	7,8,9,10,11,12,13,14,16,17,18,19mm	326,00



### Insulated adjustable wrench

CODE	L	€/Pz
FG 35/E250	250mm 10"	98,00



### 1/2"dr. insulated ratchet handle

CODE	L/mm	€/Pz
FG 625E/CR12	255	155,00



1/2"

### 1/2dr. insulated T-handle

CODE	L/mm	€/Pz
FG 625E/T12	205	90,00

Quick release system



### 1/2dr. insulated extension bars

CODE	L/mm	€/Pz
FG 625E/PR125	125	60,00
FG 625E/PR250	250	75,00



### 1/2dr. insulated hex socket bits

CODE	mm	L/mm	€/Pz
FG 150E/H4	4	76	26,00
FG 150E/H5	5	76	26,00
FG 150E/H6	6	76	26,00
FG 150E/H8	8	76	26,00
FG 150E/H10	10	76	27,00



1/2"

### 1/2dr. insulated hex socket bits - long series

CODE	mm	L/mm	€/Pz
FG 150E/LH4	4	118	31,50
FG 150E/LH5	5	118	31,50
FG 150E/LH6	6	118	31,50
FG 150E/LH8	8	118	31,50
FG 150E/LH10	10	118	34,00

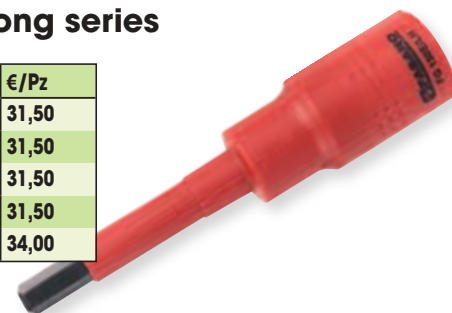

1/2"



**1/2dr. insulated hex socket wrench**

CODE	mm	L/mm	€/Pz
FG 625E/10	10	55	21,00
FG 625E/11	11	55	21,00
FG 625E/12	12	55	21,00
FG 625E/13	13	55	21,00
FG 625E/14	14	55	21,00
FG 625E/17	17	55	22,00

CODE	mm	L/mm	€/Pz
FG 625E/19	19	55	23,50
FG 625E/22	22	55	27,50
FG 625E/24	24	55	28,50
FG 625E/27	27	55	35,00
FG 625E/32	32	55	43,00



 **FG 625E/10,11,13,14,17,19,22,24,27,32**

 **FG 150E/H4,5,6,8,10**

 **FG 625E/CR12**

 **FG 625E/T12**

 **FG 625E/PR125**  
**FG 625E/PR250**

1/2"



CODE	CONTENT	€/Pz
FG 625E/S20	20pz	820,00

 **FG 625E/10,11,12,13,14,17,19,22,24**

 **FG 625E/CR12**

 **FG 625E/PR125**  
**FG 625E/PR250**

CODE	CONTENT	€/Pz
FG 625E/S12	12pz	550,00



1/2"

**Set 5pcs insulated sockets - 1/2"**

CODE	€/Pz
FG 625E/S5	125,00

CONTENT:  
10,13,14,17,19mm

**Set 5pcs insulated sockets bits - 1/2"**

CODE	€/Pz
FG 150E/S4	115,00

CONTENT:  
4, 5, 6, 8mm



### 3/8dr. insulated hex socket wrench

CODE	LENGHT	€/Pz
FG 624E/CR38	195mm	145,00



3/8"



### 3/8dr. insulated hex socket bits



CODE	mm	L/mm	€/Pz	CODE	mm	L/mm	€/Pz
FG 624E/8	8	49	16,00	FG 624E/14	14	49	18,00
FG 624E/10	10	49	16,00	FG 624E/17	17	49	20,00
FG 624E/12	12	49	16,50	FG 624E/19	19	49	22,00
FG 624E/13	13	49	17,00	FG 624E/22	22	49	24,00



3/8"

### 3/8dr. insulated hex socket bits - long series

CODE	mm	L/mm	€/Pz
FG 149E/H4	4	65	18,00
FG 149E/H5	5	65	18,20
FG 149E/H6	6	65	18,50
FG 149E/H8	8	65	21,50



3/8"



### 3/8dr. insulated T-handle

CODE	LENGHT	€/Pz
FG 624E/T38	205mm	85,00



**Quick  
release system**



3/8"



### 3/8dr. insulated extension bars

CODE	LENGHT	€/Pz
FG 624E/PR150	150mm	58,00
FG 624E/PR250	250mm	70,00



**Quick  
release system**



3/8"



3/8"



 **FG 624E/8,10,12,13,14,17,19,22**

 **FG 149E/H4,5,6,8**

 **FG 624E/CR38**

 **FG 624E/T38**

 **FG 624E/PR150**  
 **FG 624E/PR250**

CODE	CONTENT	€/Pz
FG 624E/S16	16pz	650,00



 **FG 624E/8,10,12,13,14,17,19**

 **FG 624E/CR38**

 **FG 624E/PR150**  
**FG 624E/PR250**

CODE	CONTENT	€/Pz
FG 624E/S10	10pz	450,00



3/8"

 **FG 624E/8,10,12,13,17,19**

CODE	CONTENT	€/Pz
FG 624E/S6	06pz	125,00



3/8"



 **FG 149E/H4,5,6,8**

CODE	CONTENT	€/Pz
FG 149E/S4	04pz	88,00



3/8"



## Insulated slotted screwdriver

CODE	AxB mm	L1 mm	Ø2 x L2 mm	L/mm	Q.tà min.	€/Pz
FG 22E/2.5x75	2.5x0.4	75	28.9X101	176	5pz	8,00
FG 22E/3x100	3.0x0.5	100	28.9X101	201	5pz	8,20
FG 22E/4x100	4.0x0.8	100	32.0x114	214	5pz	9,00
FG 22E/5.5x125	5.5x1.0	125	32.0x114	239	5pz	10,50
FG 22E/6.5x150	6.5x1.2	150	36.0x125	275	2pz	11,00
FG 22E/8x175	8.0x1.2	175	36.0x125	300	2pz	12,00

## Insulated Phillips screwdriver

CODE	PH	Ø1 x L1 mm	Ø2 x L2 mm	L/mm	Q.tà min.	€/Pz
FG 22E/PH0x60	0	3.0x60	28.9X100.9	161	3pz	8,00
FG 22E/PH1x80	1	4.5x80	32.0x114	194	3pz	9,00
FG 22E/PH2x100	2	6.0x100	36.0x125	225	2pz	10,00
FG 22E/PH3x150	3	8.0x150	39.4x136	286	2pz	11,00

## Insulated Pozidriv screwdriver

CODE	PZ	Ø1 x L1 mm	Ø2 x L2 mm	L/mm	Q.tà min.	€/Pz
FG 22E/PZ0x60	0	3.0x60	28.9X100.9	161	3pz	8,00
FG 22E/PZ1x80	1	4.5x80	32.0x114	194	3pz	8,80
FG 22E/PZ2x100	2	6.0x100	36.0x125	225	2pz	9,50
FG 22E/PZ3x150	3	8.0x150	39.4x136	286	2pz	11,00

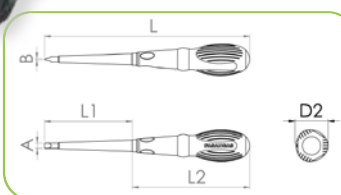

## Set of 6pcs insulated slotted screwdrivers

CODE	CONTENT	€/Pz
FG 22E/SL6	2.5x75, 3x100, 4x100, 5.5x125, 6.5x150, 8x175	62,00



## Set of 4pcs insulated Phillips screwdrivers

CODE	CONTENT	€/Pz
FG 22E/SH4	PH0x60, PH1x80, PH2x100, PH3x150	46,00



## Set of 4pcs insulated Pozidriv screwdrivers

CODE	CONTENT	€/Pz
FG 22E/SZ4	PZ0x60, PZ1x80, PZ2x100, PZ3x150	46,00



## Set of 4pcs insulated screwdrivers

CODE	CONTENT	€/Pz
FG 22E/S6	3x100, 4x100, 5.5x125 PH0x60, PH1x80, PH2x100	58,00



## Set of 4pcs insulated screwdrivers

CODE	CONTENT	€/Pz
FG 22E/SZ6	3x100, 4x100, 5.5x125 PZ0x60, PZ1x80, PZ2x100	58,00



### Circuit tester 6-24V

CODE	L/mm	€/Pz
FG 22/CF24	125	9,00



### Circuit tester 110-250V

CODE	L/mm	€/Pz
FG 22/CF250	190	7,50



DIN 0680

### Cable stripper

CODE	Ø/mm	L/mm	€/Pz
FG 68/CS1	4 - 28	105	16,00

FG 68/CS1-R

Lame de rechange: 5,70€/pz



### Cable stripper

CODE	Ø/mm	L/mm	€/Pz
FG 68/CS2	8 - 28	175	18,00

FG 68/CS2-R

Lame de rechange: 5,70€/pz



### Cable stripper

CODE	Ø/mm	L/mm	€/Pz
FG 68/CS6	8 - 28	140	25,50

FG 68/CS1-R

Lame de rechange: 5,70€/pz



### Multi-function crimping tools

CODE	L/mm	€/Pz
FG 68/SP1	140	21,00

Capacité:  
0.5 - 6mm<sup>2</sup> / 20-10AWG  
RG59 & RG6



### Crimping pliers for insulated terminals

CODE	Ømm <sup>2</sup>	AWG	L/mm	€/Pz
FG 68/S1	0.75 - 6	10-24	215	13,50



### Automatic crimping pliers for non-insulated terminals

CODE	Ømm <sup>2</sup>	AWG	L/mm	€/Pz
FG 68/SP	0.2 - 6	8-24	205	34,00

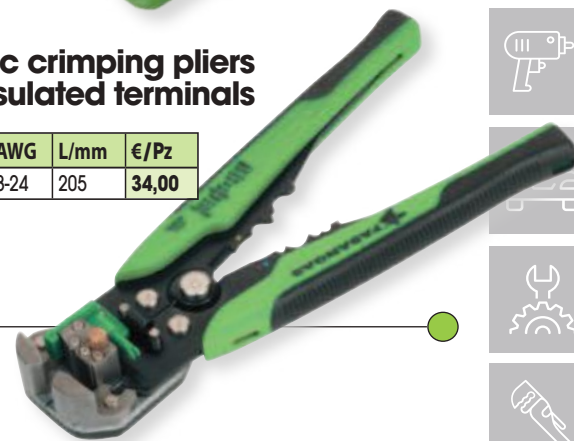

### Front wire stripping pliers with cutting blade

CODE	Ømm <sup>2</sup>	AWG	L/mm	€/Pz
FG 68/SP2	0.2 - 6	27-17	175	14,50



## Insulated combination pliers

CODE	mm/inch	€/Pz
FG 59/IS180	180 - 7"	37,50
FG 59/IS200	200 - 8"	40,00

- DIN ISO 5746

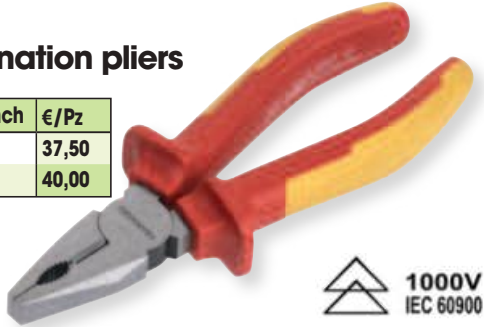

## Insulated long nose pliers

CODE	mm/inch	€/Pz
FG 61/IS200	200 - 8"	39,00

- DIN ISO 5745



## Insulated diagonal cutting pliers

CODE	mm/inch	€/Pz
FG 63/IS160	160 - 6"	38,50

- DIN ISO 5745



## Insulated diagonal cutting pliers - heavy duty model

CODE	mm/inch	€/Pz
FG 63/HIS180	180 - 7"	42,00
FG 63/HIS200	200 - 8"	43,00

- DIN ISO 5749



## Insulated wire stripping pliers

CODE	mm/inch	€/Pz
FG 68/IS160	160 - 6"	38,00

- DIN ISO 8979

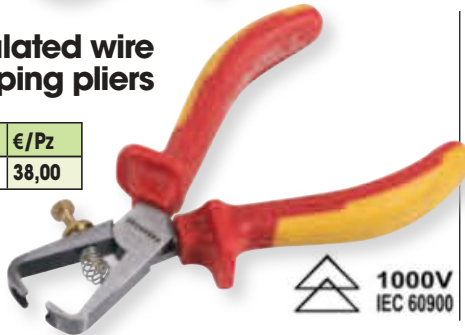

## Insulated adjustable pliers - DIN ISO 8976

CODE	mm/inch	€/Pz
FG 58/IS250	250 - 9.5"	54,00

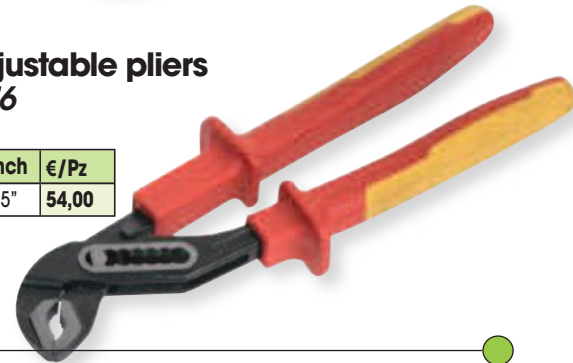

## Set of 3pcs insulated pliers

- FG 59/IS180, FG 61/IS200, FG 63/IS160

CODE	€/Pz
FG 59IS/S3	118,50

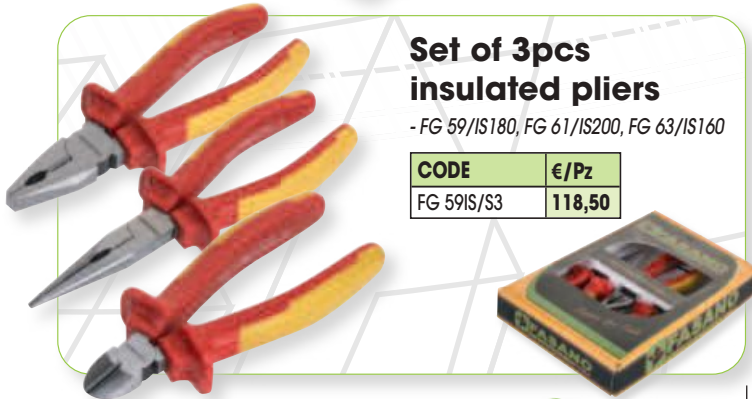

## Electrician's scissor

CODE	L/mm	€/Pz
FG 49/E	155	40,00



## Cable cutter for copper and aluminum cables

CODE	L/mm	€/Pz
FG 68/TC230	230	83,00

Capacity: 17 Ømm



## Insulated cutter

CODE	L/mm	€/Pz
FG 48/IS	185	24,00



## Cable cutter for copper cables - no insulated

CODE	L/mm	€/Pz
FG 68/CC	600	168,00

Capacity: 255mm<sup>2</sup> - 32 Ømm

## Ratchet cable cutter - no insulated

CODE	L/mm	€/Pz
FG 68/CR	255	205,00

Capacity: 325mm<sup>2</sup> - 36 Ømm



**Set of 26pcs insulated tools**

CODE	€/Pz
FG 603/S26	850,00

*Ideal for electric and hybrid vehicles*



FG 59/IS200

FG 625E/CR12

FG 61/IS200

FG 625E/PR250

FG 63/IS160

FG 49/E

FG 603/E10,11,12,13,14,17,19

FG 48/IS

FG 625E/10,11,12,13,14,17,19

FG 22/CF250

FG 22E/4X100, 5.5X125, FG 22E/PH1X80, PH2X100



**Dielectric helmet - 1.000V**

CODE	€/Pz
FG 603/EL	40,00



**Dielectric gloves - 1.000V**

CODE	SIZE	€/Pz
FG 603/GU9	9	115,00
FG 603/GU10	10	115,00



**Dielectric helmet - 1.000V**

CODE	€/Pz
FG 603/EL1	150,00



**Insulated carpet - 1.000x1.000x3mm**

CODE	€/Pz
FG 603/TA1	270,00

**DC/AC - Ohm digital multimeter**

FUNCTIONS	
DC	400mV (± 1.0%+5), 4V, 40V, 300V (± 0.8%+3)
AC	4 V , 40 V , 300 V (± 1.0%+5)
Ω	400 Ω (± 1.0%+5), 4KΩ , 40kΩ , 400kΩ, 4MΩ (± 1.0%+3), 40MΩ (± 2.0%+5)
CAPACITY	4nF , 40nF , 400nF , 4μF , 40 μF (± 4.0%+5), 100 μF (± 8.0%+5)
FREQUENCY	10Hz, 100Hz, 1kHz, 10kHz (± 0.8%+3), 100kHz, 200kHz (± 1.0%+3)
DUTY CYCLE	5% - 95% (± 0.1%)
CONTINUITY TEST	SI
DIODE TEST	SI
TEMPERATURE	-20°C / 400°C (± 1.5% ± 3 0°C) 400°C / 1.000°C (± 2.0% ± 3 0°C)
HUMIDITY CAPACITY	30% - 90% RH (± 0.1%)
LUX	4.000 Lux (± 1) / 40.000 Lux (± 10)
SOUND CAPACITY	35 - 100dB (± 0.1dB)
STANDBY	Dopo 15 minuti
BATTERY INDICATOR	SI
BATTERY	9V
DIMENSION	8x3.5x16.5H mm

CODE	€/Pz
FG 96/DG	185,00

CLASS III



**FUNCTIONS:**

- TEMPERATURE GAUGE
- HUMIDITY GAUGE
- LUXOMETER
- SOUND LEVEL METER



### Crimping pliers for cylindrical terminals

CODE	Ømm <sup>2</sup> - AWG	€/Pz
FG 68/AT6	0.5-4 / 20-10AWG	65,00
FG 68/AT16	6-16 / 10-5AWG	65,00



### Crimping pliers for insulated terminals

CODE	Ømm <sup>2</sup> - AWG	€/Pz
FG 68/AG	0.5-6 / 10-22AWG	65,00



### Crimping pliers for NO insulated terminals

CODE	Ømm <sup>2</sup> - AWG	€/Pz
FG 68/NI	0.5-2.5/20-13AWG	73,00



### Crimping pliers for BNC connectors for coaxial wires - RG58, RG62 e RG71

CODE	€/Pz
FG 68/BNC	94,00



### Ratchet crimping pliers for telephone terminals and data transmission - RJ4, RJ6, RJ8

CODE	Ømm <sup>2</sup> - AWG	€/Pz
FG 68/RJ	RJ10, RJ11/12, RJ45	73,00



### Universal crimping pliers with interchangeable dies

CODE	L/mm	€/Pz
FG 68/UN	220	86,00



### Interchangeable dies for FG 68/UN

CODE	FOR:	Ømm <sup>2</sup>	€/Pz
FG 68/MAT4	Capicorda a tubetto	0.5 - 4	42,00
FG 68/MAT16	Capicorda a tubetto	6 - 16	42,00
FG 68/MAG	Capicorda preisolati	0.5 - 6	42,00
FG 68/MAN	Capicorda NON isolati	1.5 - 10	42,00
FG 68/MAS	Terminali NON isolati	0.5 - .5	42,00

FG 68/MAT4



FG 68/MAT16



FG 68/MAG



FG 68/MAN



FG 68/MAS



### Set of universal crimping pliers + 3 dies (FG 68/MAT4, FG 68/MAT16, FG 68/MAG), with assortment of 435pcs terminals

CODE	CONTENT	€/Pz
FG 68U/S439	439pz	290,00



**Slotted micro-screwdriver**

CODE	mm	L/mm	Q.tà min.	€/Pz
FG 84/F1	0.2x1.2	130	03pz	4,40
FG 84/F2	0.2x1.5	130	03pz	4,40
FG 84/F3	0.4x2.0	130	03pz	4,40
FG 84/F4	0.4x2.5	140	03pz	4,40
FG 84/F5	0.5x3.0	150	03pz	4,40
FG 84/F7	0.8x4.0	150	03pz	4,40

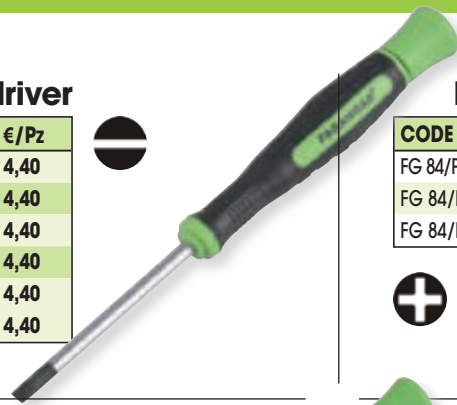

**Phillips micro-screwdriver**

CODE	PH	L/mm	Q.tà min.	€/Pz
FG 84/PH00	00	130	03pz	4,40
FG 84/PH0	0	130	03pz	4,40
FG 84/PH1	1	140	03pz	4,40



**Hex micro-screwdriver**

CODE	TX	L/mm	Q.tà min.	€/Pz
FG 84/H1.5	1.5	140	03pz	5,20
FG 84/H2	2.0	140	03pz	5,20
FG 84/H2.5	2.5	150	03pz	5,20
FG 84/H3	3.0	150	03pz	5,20



**Torx micro-screwdriver**

CODE	TX	L/mm	Q.tà min.	€/Pz
FG 84/TX3	3	130	03pz	5,10
FG 84/TX4	4	130	03pz	5,10
FG 84/TX5	5	130	03pz	5,10
FG 84/TX6	6	130	03pz	5,10
FG 84/TX7	7	130	03pz	5,10
FG 84/TX8	8	140	03pz	5,10
FG 84/TX9	9	150	03pz	5,10
FG 84/TX10	10	150	03pz	5,10
FG 84/TX15	15	150	03pz	5,10
FG 84/TX20	20	150	03pz	5,10



**Set of 6pcs micro-screwdrivers**

CODE	pz	CONTENT	€/Pz
FG 84F/S6	6	1.2, 1.5, 2.0, 2.5, 3.0, 4.0	29,00
FG 84F/S6B	6	1.2, 1.5, 2.0, 2.5, 3.0, 4.0	29,00
FG 84F/S6C	6	1.2, 1.5, 2.0, 2.5, 3.0, 4.0	29,00

CODE	Pz	CONTENT	€/Pz
FG 84PH/S6	6	1.5, 2.0, 3.0, 4.0 PH00, PH0	29,00
FG 84PH/S6B	6	2.0, 2.5, 3.0, 4.0 PH0, PH1	29,00

CODE	Pz	CONTENT	€/Pz
FG 84TX/S6	6	TX07, TX08, TX09, TX10, TX15, TX20	32,00

**Straight large knurled end spring tweezers**

CODE	L/mm	€/Pz
FG 85/TW1	115	12,30



**Extra slim short end spring tweezers**

CODE	L/mm	€/Pz
FG 85/TW2	120	12,30



**Strong straight end spring tweezers**

CODE	L/mm	€/Pz
FG 85/TW3	120	12,30

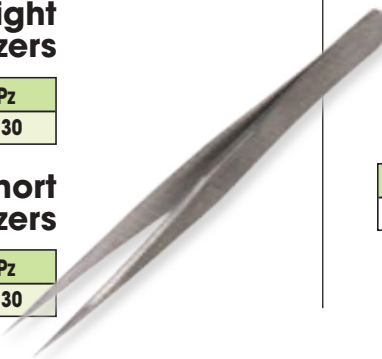

**Extra slim short end spring tweezers**

CODE	L/mm	€/Pz
FG 85/TW4	110	12,30



**Extra slim curved end spring tweezers**

CODE	L/mm	€/Pz
FG 85/TW5	120	12,30

**STAINLESS STEEL  
MAGNETIC AND ACID RESISTANT**



## MICRO-PLIERS

Dedicated to the electronic industry, FASANO introduces a new range of 22 different models of micro-pliers, in order to meet all the specific needs during use.

- New ergonomically designed handle
- Beaks products with the best steel, for maximize the reliability!

### FLATE NOSES

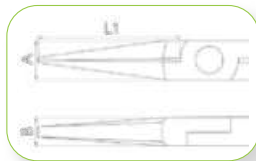

L1/mm: 40  
A/mm: 12  
B/mm: 8

#### Flat long nose pliers

CODE	L/mm	€/Pz
FG 80/BL140	140	31,00

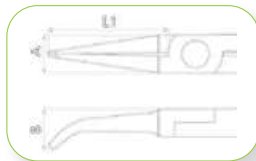

L1/mm: 38  
A/mm: 12  
B/mm: 13

#### Flat long curved nose pliers

CODE	L/mm	€/Pz
FG 80/BLP140	140	31,00

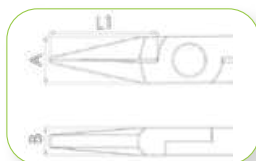

L1/mm: 18  
A/mm: 12  
B/mm: 8

#### Flat long short nose pliers

CODE	L/mm	€/Pz
FG 80/BP125	125	31,00



### ROUND NOSES

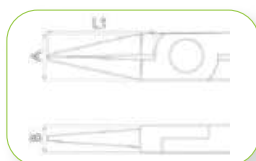

L1/mm: 40  
A/mm: 12  
B/mm: 8

#### Round short nose pliers

CODE	L/mm	€/Pz
FG 81/BT125	125	31,00



## HALF-ROUND NOSES

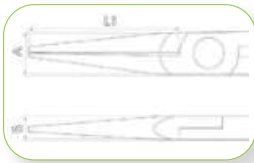

L1/mm: 40  
A/mm: 12  
B/mm: 8

### Smooth half-round long nose pliers

CODE	L/mm	€/Pz
FG 81/BML140	140	31,00

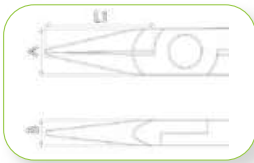

L1/mm: 29  
A/mm: 12  
B/mm: 8

### Smooth half-round short nose pliers

CODE	L/mm	€/Pz
FG 81/BMC140	140	31,00

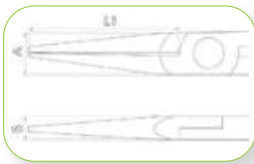

L1/mm: 39  
A/mm: 12  
B/mm: 8

### Half-round long k nurlled nose pliers

CODE	L/mm	€/Pz
FG 81/BMZ140	140	31,00



## HALF-ROUND NEEDLE NOSES

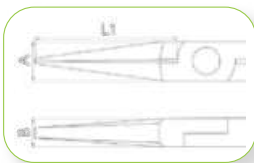

L1/mm: 37  
A/mm: 12  
B/mm: 8

### Smooth half-round long needle nose pliers

CODE	L/mm	€/Pz
FG 81/BMR140	140	31,00

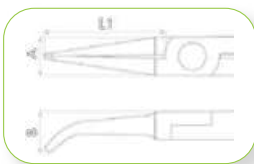

L1/mm: 36.5  
A/mm: 12  
B/mm: 12

### Smooth half-round long curved needle nose pliers

CODE	L/mm	€/Pz
FG 81/BMP140	125	31,00





## SEMI-FLUSH NOSES

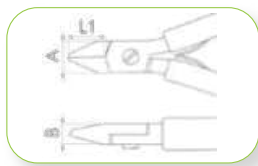

L1/mm: 11  
A/mm: 10  
B/mm: 1

**Diagonal semi-flush  
cutting pliers  
-slim tips**

CODE	L/mm	€/Pz
FG 82/TDS120	120	31,00

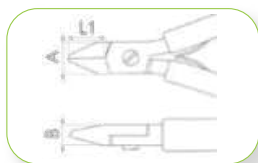

L1/mm: 11  
A/mm: 10  
Cut/: 1

**Diagonal semi-flush  
cutting pliers  
-rounded tips**

CODE	L/mm	€/Pz
FG 82/DSA120	120	31,00



## FLUSH NOSES

L1/mm: 11  
A/mm: 10  
Cut/: 1

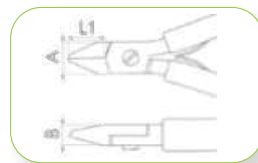
**Diagonal flush cutting  
pliers -slim tips**

CODE	L/mm	€/Pz
FG 82/DRS120	120	31,00
FG 82/DRS130	130	35,00



L1/mm: 13  
A/mm: 12.5  
Cut/: 1.25

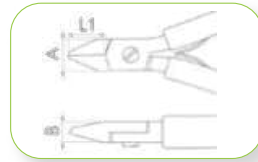

L1/mm: 11  
A/mm: 10  
Cut/: 1

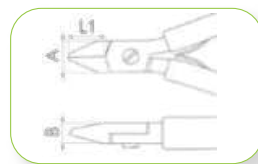
**Diagonal flush cutting  
pliers -rounded tips**

CODE	L/mm	€/Pz
FG 82/DRA120	120	31,00
FG 82/DRA130	130	34,50



L1/mm: 13  
A/mm: 12.5  
Cut/: 1.25

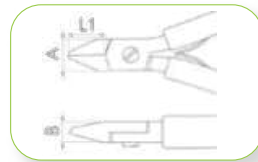

L1/mm: 11  
A/mm: 10  
Cut/: 1

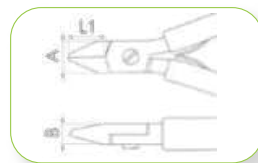
**Diagonal flush cutting  
pliers -slim tapering tips**

CODE	L/mm	€/Pz
FG 82/RAS120	120	31,00
FG 82/RAS130	130	35,00



L1/mm: 13  
A/mm: 12.5  
Cut/: 1.25

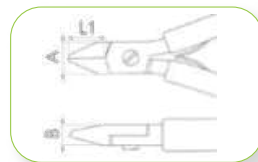

## END CUTTING

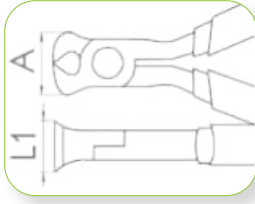

L1/mm: 12  
A/mm: 12  
Cut: 1.25

### End semi-flush cutting pliers

CODE	L/mm	€/Pz
FG 83/TF120	120	31,00



## DIAGONAL CUTTING

L1/mm: 17  
A/mm: 5  
Cut: 2

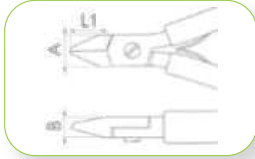

### diagonal axial cutting pliers

CODE	L/mm	€/Pz
FG 83/TD130	130	35,00



## DIAGONAL FLUSH CUTTING

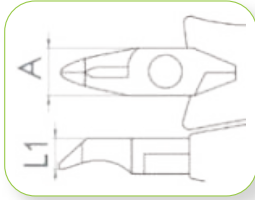

L1/mm: 8  
A/mm: 12  
Cut: 0.8

### End flush long oblique cutting pliers

CODE	L/mm	€/Pz
FG 84/TOR130	130	35,00

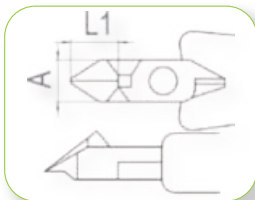

L1/mm: 18  
A/mm: 12  
Cut: 1

### End flush long oblique cutting pliers - with wire stripping

CODE	L/mm	€/Pz
FG 84/ORS130	130	35,00





SPORT 4 SUV



MADE IN GERMANY

FG 5362 40-200N·m

FASANO

EXTRA LOAD

CE 01/12 2011

DANGER OF INJURY

SWISSMA

# 05

## TORQUE TOOLS

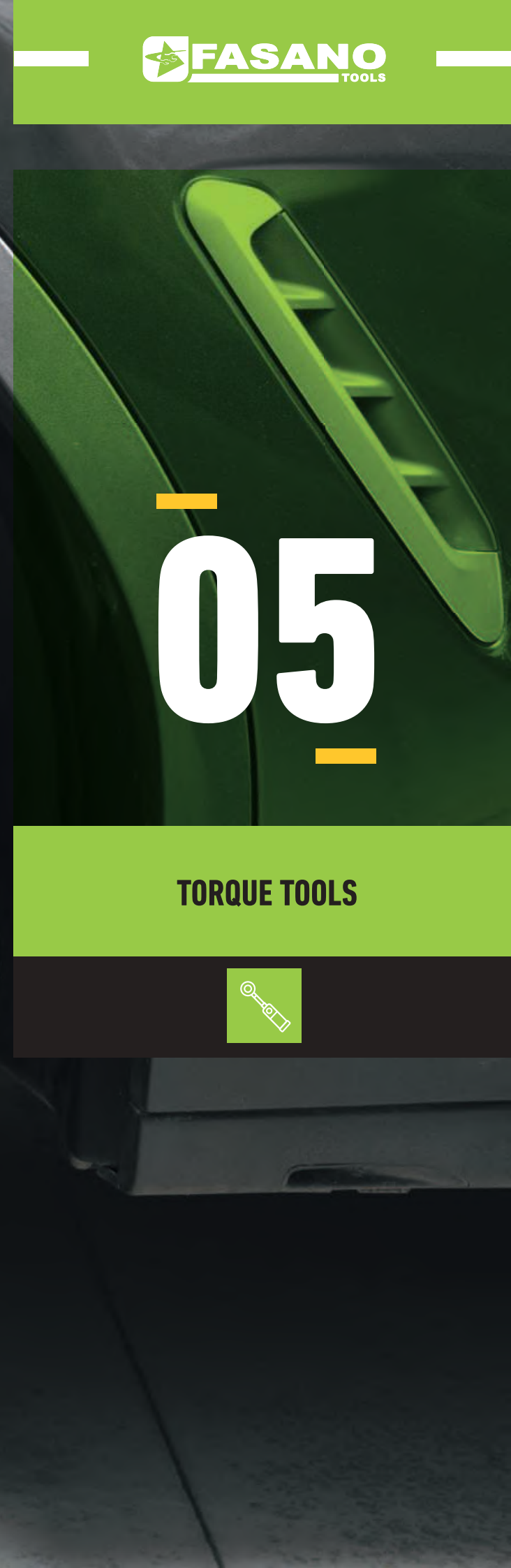

**1/4"dr. Torque wrench**

CODE	■	Nm	€/Pz
FG 531	1/4"	5-25	205,00

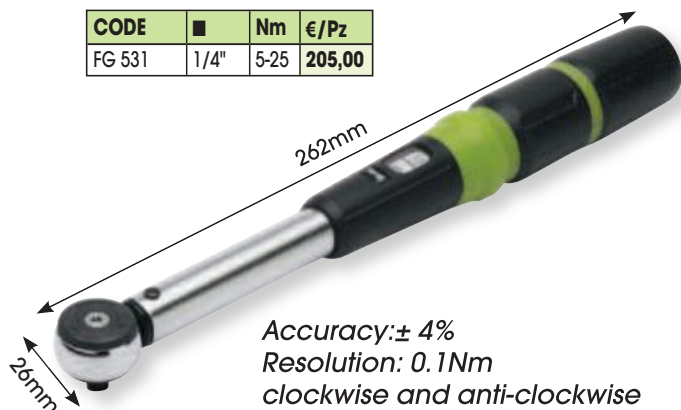
**3/8"dr. Torque wrench**

CODE	■	Nm	€/Pz
FG 533/2	3/8"	10-50	230,00

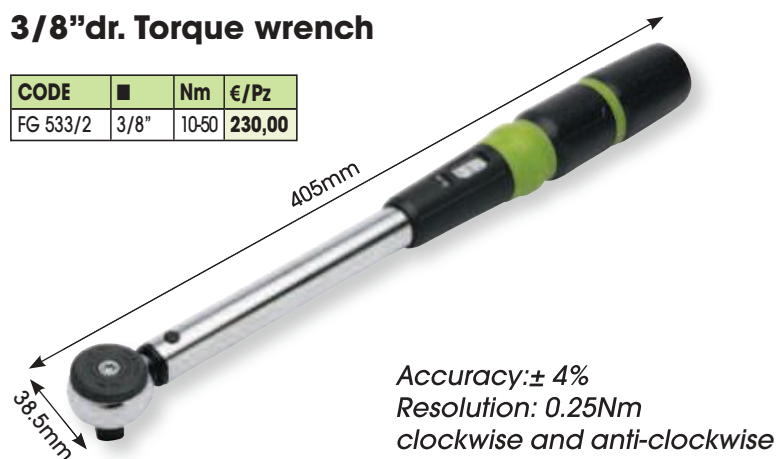
**1/2"dr. Torque wrench**

CODE	■	Nm	RISOLUZIONE	D/mm	L/mm	€/Pz
FG 536/1	1/2"	20-100	0.5Nm	38.5	405.0	230,00
FG 536/2	1/2"	40-200	1.0Nm	38.5	505.0	250,00
FG 536/3	1/2"	60-340	2.0Nm	40.0	565.0	255,00

Accuracy: ± 4%  
clockwise and anti-clockwise

**Torque wrench with 1/4"dr. interchangeable hexagon bit**

CODE	■	Nm	%	€/Pz
FG 528	1/4"	1-5	±6	415,00

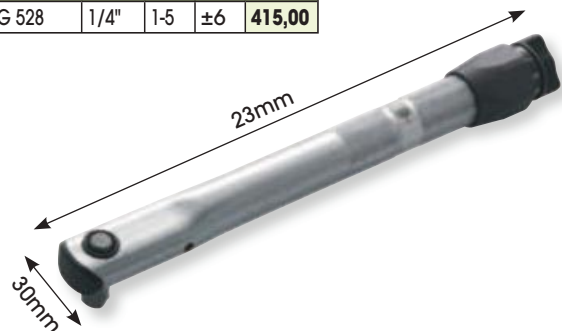
**Torque angle indicator**

CODE	□	Ø/mm	L/mm	€/Pz
FG 560/A	1/2"	63	410	70,00
FG 561	3/4"	83	610	150,00

**Torque angle indicator**

CODE	□	Ø/mm	L/mm	€/Pz
FG 560	1/2"	63	410	70,00

**Torque angle indicator**

CODE	□	€/Pz
FG 562	1/2"	58,00



## 1/2"dr. digital torque wrench Nm and Degree function

CODE	■	Nm	Gradi	D/mm	L/mm	€/Pz
FG 543/DG1	1/2"	6.8 - 135	1 - 360	34.0	396	630,00
FG 543/DG2	1/2"	10 - 200	1 - 360	43.0	480	740,00

**Accuracy: ± 4%**  
clockwise and anti-clockwise

Double measurement mode:  
PEAK and TRACK

Visual and audible indicator with 12 LED at achievement of the predetermined torque

Possibility to memorize up to 250 different drafts thanks to the software included  
PC interface via USB

Ability to set up to 9 pre-defined drafts

Power supply: 2 1.5V batteries (included)



## Digital angle meter - Nm and Angle

CODE	Nm	Gradi	A/mm	H/mm	€/Pz
FG 546/DG	10 - 200	1 - 360	85	80	310,00

**Accuracy: ± 2%**  
clockwise and anti-clockwise

Double measurement mode:  
PEAK and TRACK

Visual and audible indicator with 6 LED at achievement of the predetermined torque

Possibility to memorize up to 50 different drafts

Power supply: 2 1.5V batteries (included)



## Digital angle meter

CODE	Gradi	A/mm	H/mm	€/Pz
FG 547/DG	1 - 360	58	41	195,00

**Accuracy: ± 2%**  
clockwise and anti-clockwise

Visual and audible indicator with 6 LED at achievement of the predetermined torque

Back magnetic support



**3/4"dr. torque bar**Accuracy  $\pm 4\%$ 

CODE	■	Nm	L/mm	€/Pz
FG 538/1	3/4"	140-560	996	<b>800,00</b>
FG 538/2	3/4"	200-800	1.070	<b>880,00</b>



Supplied in ABS case

**1"dr. torque bar**Accuracy:  $\pm 4\%$ 

CODE	■	Nm	L/mm	€/Pz
FG 539/1	1"	200-1000	1.400	<b>1.150,00</b>



Supplied in ABS case

**3/4"dr. torque wrench**Accuracy:  $\pm 4\%$ 

CODE	■	Nm	A/mm	L/mm	€/Pz
FG 537/1	3/4"	110-550	61.0	845	<b>1.400,00</b>



Supplied in ABS case

**Aluminum torque wrench**Accuracy:  $\pm 4\%$ 

CODE	■	Nm	Weight	L/mm	€/Pz
FG 537/AL1	3/4"	110-550	3.000gr	820	<b>1.450,00</b>
FG 537/AL2	3/4"	140-760	3.000gr	820	<b>1.600,00</b>
FG 537/AL3	3/4"	200-1.000	3.000gr	820	<b>1.900,00</b>
FG 539/AL1	1"	600-1.500	10.900gr	1.615	<b>2.750,00</b>



Supplied in ABS case

**ALUMINUM  
SERIES**

### 14x18mm torque bar

CODE	Nm	RES.	L/mm	€/Pz
FG 542/4	60-300	1.0	546	<b>282,00</b>

Accuracy: ± 3%

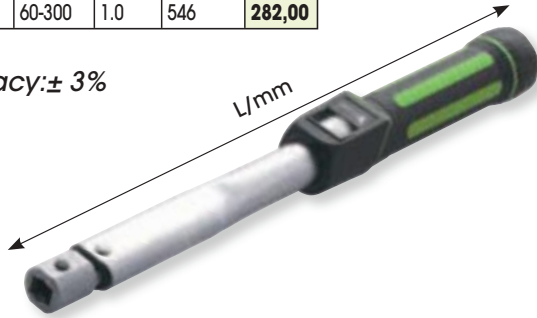

### 9x12mm torque bar

CODE	Nm	RES.	L/mm	€/Pz
FG 544/1	5-25	0.1	259	<b>245,00</b>
FG 544/2	10-50	0.25	385	<b>210,00</b>
FG 544/3	20-100	0.5	385	<b>225,00</b>

### 14x18mm torque bar

CODE	Nm	RES.	L/mm	€/Pz
FG 544/4	40-200	1.0	480	<b>270,00</b>

Accuracy: ± 4%

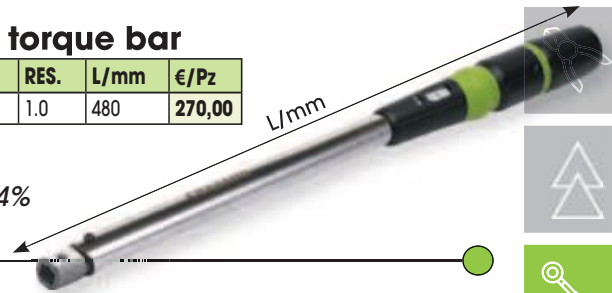

### Open ends for torque bars



9x12

14x18

CODE	mm	€/Pz
FG 546/A7	7	<b>25,00</b>
FG 546/A8	8	<b>25,00</b>
FG 546/A10	10	<b>25,00</b>
FG 546/A12	12	<b>25,00</b>
FG 546/A13	13	<b>25,00</b>
FG 546/A14	14	<b>26,00</b>
FG 546/A15	15	<b>28,00</b>
FG 546/A16	16	<b>28,00</b>
FG 546/A17	17	<b>28,00</b>
FG 546/A18	18	<b>28,00</b>
FG 546/A19	19	<b>28,00</b>

CODE	mm	€/Pz
FG 547/A13	13	<b>31,50</b>
FG 547/A14	14	<b>31,50</b>
FG 547/A15	15	<b>31,50</b>
FG 547/A16	16	<b>31,50</b>
FG 547/A17	17	<b>31,50</b>
FG 547/A18	18	<b>31,50</b>
FG 547/A19	19	<b>31,50</b>
FG 547/A21	21	<b>35,00</b>
FG 547/A22	22	<b>35,00</b>
FG 547/A24	24	<b>36,00</b>
FG 547/A27	27	<b>42,00</b>
FG 547/A30	30	<b>46,00</b>
FG 547/A32	32	<b>50,00</b>
FG 547/A34	34	<b>60,00</b>
FG 547/A36	36	<b>68,00</b>
FG 547/A41	41	<b>88,00</b>

### Ring ends for torque bars



9x12

14x18

CODE	mm	€/Pz
FG 548/A7	7	<b>27,00</b>
FG 548/A8	8	<b>27,00</b>
FG 548/A10	10	<b>27,00</b>
FG 548/A12	12	<b>27,00</b>
FG 548/A13	13	<b>27,00</b>
FG 548/A14	14	<b>27,00</b>
FG 548/A15	15	<b>28,00</b>
FG 548/A16	16	<b>28,00</b>
FG 548/A17	17	<b>28,00</b>
FG 548/A18	18	<b>28,00</b>
FG 548/A19	19	<b>28,00</b>
FG 548/A21	21	<b>33,00</b>
FG 548/A22	22	<b>35,00</b>

CODE	mm	€/Pz
FG 549/A13	13	<b>33,00</b>
FG 549/A14	14	<b>33,00</b>
FG 549/A15	15	<b>33,00</b>
FG 549/A16	16	<b>33,00</b>
FG 549/A17	17	<b>34,00</b>
FG 549/A18	18	<b>34,00</b>
FG 549/A19	19	<b>34,00</b>
FG 549/A21	21	<b>38,00</b>
FG 549/A22	22	<b>38,00</b>
FG 549/A24	24	<b>40,00</b>
FG 549/A27	27	<b>43,00</b>
FG 549/A30	30	<b>46,00</b>
FG 549/A32	32	<b>49,00</b>
FG 549/A34	34	<b>60,00</b>
FG 549/A36	36	<b>68,00</b>
FG 549/A41	41	<b>88,00</b>

### Ratchet heads for torque bars

CODE	DRIVE	■	€/Pz
FG 545/1	9x12mm	1/4"	<b>40,00</b>
FG 545/2	9x12mm	3/8"	<b>46,00</b>
FG 545/3	9x12mm	1/2"	<b>49,00</b>
FG 545/4	14x18mm	1/2"	<b>52,00</b>



### Torque screwdriver

CODE		Nm	L/mm.	€/Pz
FG 559/1	1/4"	0.1- 1.2	155	<b>210,00</b>
FG 559/2	1/4"	1 - 6	155	<b>220,00</b>
FG 559/3	1/4"	5 - 10	155	<b>225,00</b>

Accuracy: ± 6%





### Mini-Torque multiplier clockwise/anticlockwise

CODE	Max output	Nm	€/Pz
FG 580/A	600 Nm	445	270,00

1/2"x1/2"  
Rapporto: 3.4:1



### Mini-Torque multiplier clockwise/anticlockwise

CODE	Max output	Nm	€/Pz
FG 580/B	800	590	370,00

1/2"x3/4"  
Rapporto: 3.4:1



### Torque multiplier clockwise/anticlockwise



CODE	□ x ■	Ratio	Nm	lbf.ft	€/Pz
FG 581/A	1/2" x 3/4"	1:6.5	231-1.500	1.106	800,00
FG 581/B	1/2" x 1"	1:12	208-2.500	1.844	1.320,00

### Electronic digital torque meter for checking calibration to be used either clockwise or anticlockwise

Accuracy:  $\pm 1\%$   
Display: 4 digit

CODE	□	Nm	€/Pz
FG 579	1/4"	1-20	1.800,00



### 9X12mm torque bar with anti-tamper system

Accuracy:  $\pm 3\%$

CODE	□	Nm	L/mm	€/Pz
FG 551/1	9x12mm	1-20	203	240,00



### Torque bar with anti-tamper system

Accuracy:  $\pm 3\%$

CODE	□	Nm	L/mm	€/Pz
FG 552/1	9x12mm	8-60	280	275,00
FG 552/2	9x12mm	10-100	319	275,00
FG 552/3	14x18mm	40-200	400	310,00

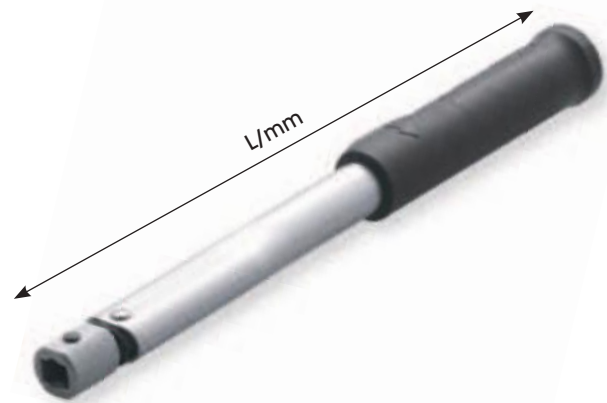

### Torque bar with anti-tamper system

Accuracy:  $\pm 3\%$

Break angle of 20° limited

CODE	□	Nm	L/mm	€/Pz
FG 553/1	9x12mm	5-25	240	295,00



### Torque screwdriver with anti-tamper system

Accuracy:  $\pm 6\%$

CODE	□	Nm	L/mm.	€/Pz
FG 558/2	1/4"	1-6	195	220,00





FASANO TOOLS

FG 132/

# 06

**PERCUSSION TOOLS**



## Engineer's hammer with wooden handle

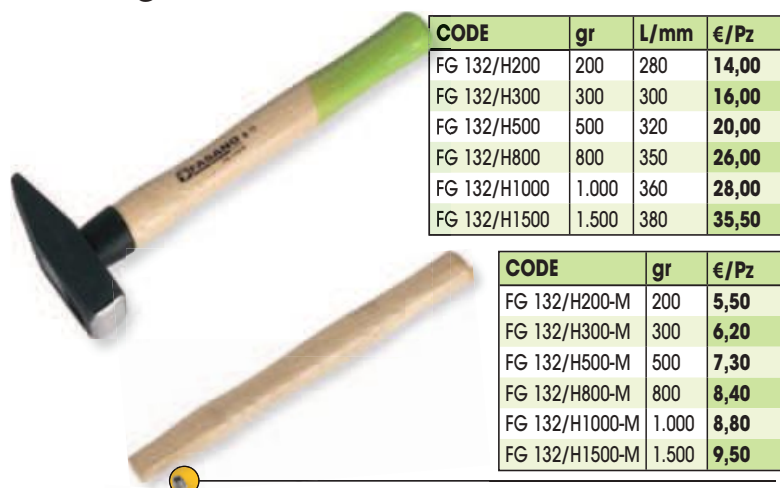

CODE	gr	L/mm	€/Pz
FG 132/H200	200	280	14,00
FG 132/H300	300	300	16,00
FG 132/H500	500	320	20,00
FG 132/H800	800	350	26,00
FG 132/H1000	1.000	360	28,00
FG 132/H1500	1.500	380	35,50

CODE	gr	€/Pz
FG 132/H200-M	200	5,50
FG 132/H300-M	300	6,20
FG 132/H500-M	500	7,30
FG 132/H800-M	800	8,40
FG 132/H1000-M	1.000	8,80
FG 132/H1500-M	1.500	9,50

## Club hammer with wooden handle and safety collar

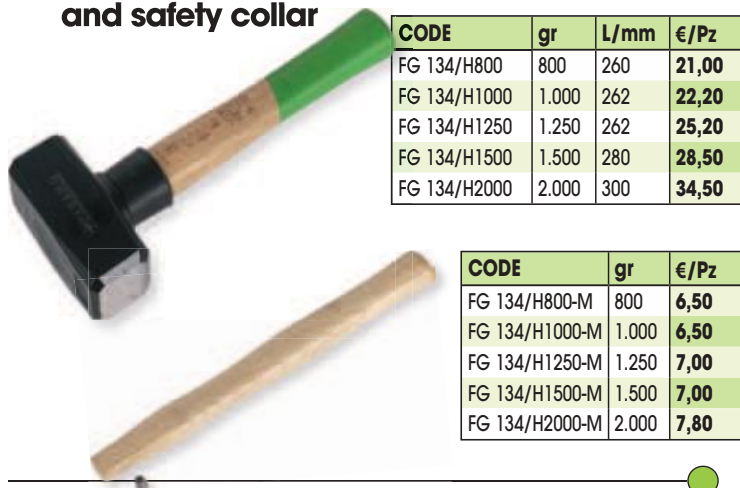

CODE	gr	L/mm	€/Pz
FG 134/H800	800	260	21,00
FG 134/H1000	1.000	262	22,20
FG 134/H1250	1.250	262	25,20
FG 134/H1500	1.500	280	28,50
FG 134/H2000	2.000	300	34,50

CODE	gr	€/Pz
FG 134/H800-M	800	6,50
FG 134/H1000-M	1.000	6,50
FG 134/H1250-M	1.250	7,00
FG 134/H1500-M	1.500	7,00
FG 134/H2000-M	2.000	7,80

## Engineer's hammer with resin handle



CODE	gr	L/mm	€/Pz
FG 132/200	200	294	17,70
FG 132/300	300	297	19,50
FG 132/500	500	312	20,50
FG 132/800	800	342	26,00
FG 132/1000	1.000	343	28,50

## Copper head hammers, wooden handle



CODE	gr	L/mm	€/Pz
FG 134/R300	250	280	33,00
FG 134/R500	500	310	52,00
FG 134/R800	800	316	78,00
FG 134/R1000	1.000	330	95,00

## Ball pein hammer with wooden handle and safety collar

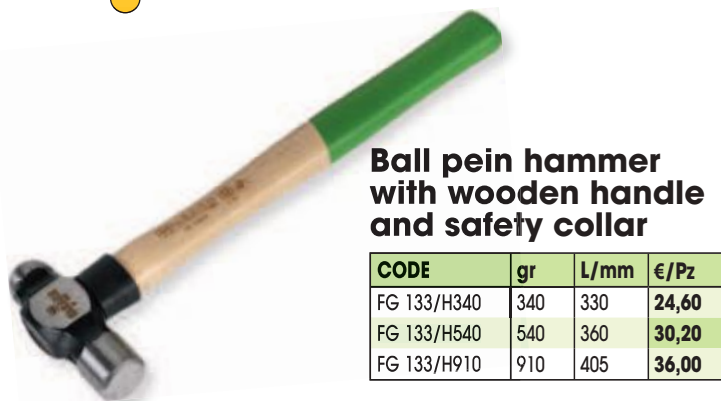

CODE	gr	L/mm	€/Pz
FG 133/H340	340	330	24,60
FG 133/H540	540	360	30,20
FG 133/H910	910	405	36,00

## Electrician's hammers with wooden handle



CODE	gr	L/mm	€/Pz
FG 132/E200	200	260	15,00

## Dead-blow hammers interchangeable plastic faces

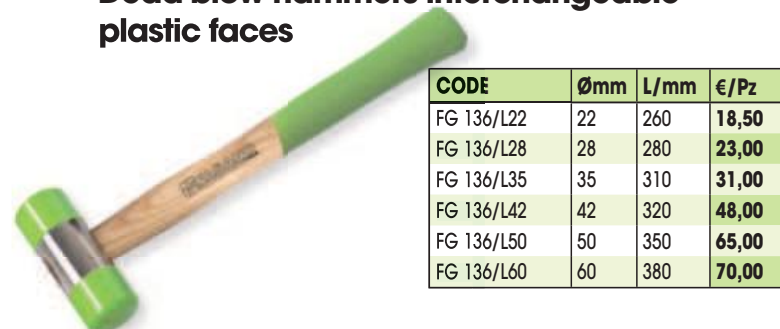

CODE	Ømm	L/mm	€/Pz
FG 136/L22	22	260	18,50
FG 136/L28	28	280	23,00
FG 136/L35	35	310	31,00
FG 136/L42	42	320	48,00
FG 136/L50	50	350	65,00
FG 136/L60	60	380	70,00

## Handle parts for dead-blow hammer

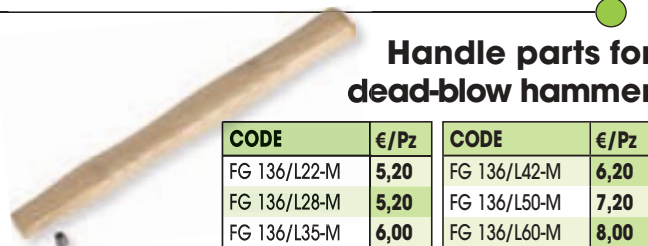

CODE	€/Pz	CODE	€/Pz
FG 136/L22-M	5,20	FG 136/L42-M	6,20
FG 136/L28-M	5,20	FG 136/L50-M	7,20
FG 136/L35-M	6,00	FG 136/L60-M	8,00

## Plastic faces

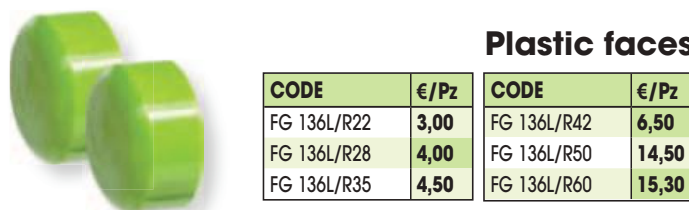

CODE	€/Pz	CODE	€/Pz
FG 136/LR22	3,00	FG 136/LR42	6,50
FG 136/LR28	4,00	FG 136/LR50	14,50
FG 136/LR35	4,50	FG 136/LR60	15,30

## Dead-blow hammers interchangeable plastic faces



CODE	Ømm	L/mm	€/Pz
FG 136/30	30	310	48,00
FG 136/40	40	320	58,00
FG 136/50	50	350	68,00

### Plastic faces (price for pair)

CODE	€/Pz
FG 136/R30	8,50
FG 136/R40	10,50
FG 136/R50	16,00



## Dead-blow hammer

CODE	Ø mm	gr. / OZ.	L/mm	€/Pz
FG 135/35	35	400 / 14	275	24,50
FG 135/45	45	500 / 18	295	32,00
FG 135/50	50	795 / 28	320	33,00
FG 135/60	60	1.270 / 44	360	45,00

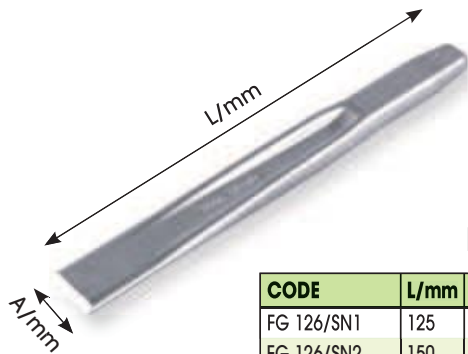

## Ribbed chisel

CODE	L/mm	A/mm	Min.	€/Pz
FG 126/SN1	125	17.0	5pcs	11,70
FG 126/SN2	150	21.0	5pcs	14,00
FG 126/SN3	200	25.0	5pcs	22,50
FG 126/SN4	250	29.0	3pcs	31,50
FG 126/SN5	300	34.0	3pcs	42,50

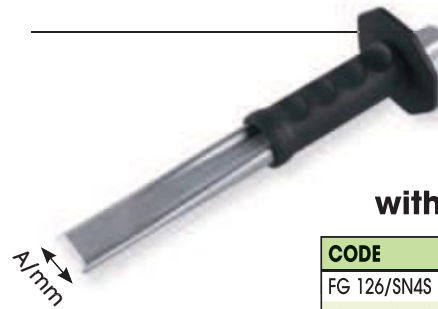

## Ribbed chisel with safety handle

CODE	gr	L/mm	€/Pz
FG 126/SN4S	250	29.0	40,50
FG 126/SN5S	300	34.0	52,00



## Safety handle for ribbed chisel

CODE	FOR:	€/Pz
FG 126SH/SN4	FG 127/SN4	9,00
FG 126SH/SN5	FG 126/SN5	9,00

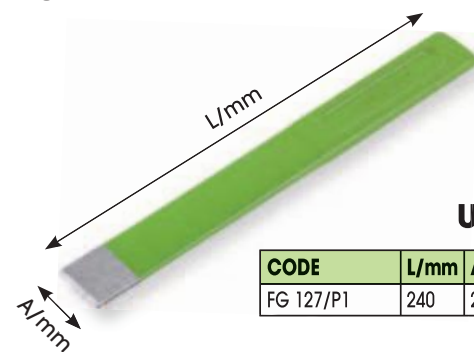

## Ultra-flat chisel

CODE	L/mm	A/mm	Min.	€/Pz
FG 127/P1	240	26.0	5pcs	17,00

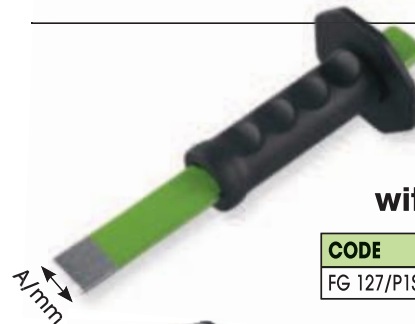

## Ultra-flat chisel with safety handle

CODE	L/mm	A/mm	€/Pz
FG 127/P1S	240	26.0	27,00



## Safety handle for ultra-flat chisel

CODE	FOR:	€/Pz
FG 127SH/P1	FG 127/P1	10,00

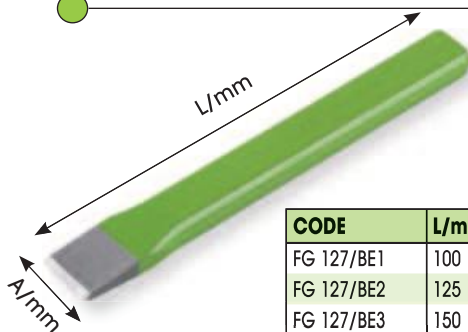

## Mortise chisel

CODE	L/mm	A/mm	Min.	€/Pz
FG 127/BE1	100	15.0	5pz	8,30
FG 127/BE2	125	15.0	5pz	8,30
FG 127/BE3	150	18.0	5pz	8,80
FG 127/BE4	175	21.0	5pz	13,00
FG 127/BE6	250	25.0	3pz	19,50
FG 127/BE7	250	28.0	3pz	20,00



## Mortise chisel with safety handle

CODE	gr	L/mm	€/Pz
FG 127/BE6S	250	25.0	26,50
FG 127/BE7S	250	28.0	27,00



## Safety handle

CODE	€/Pz
FG 127SH/BE5-8	8,00



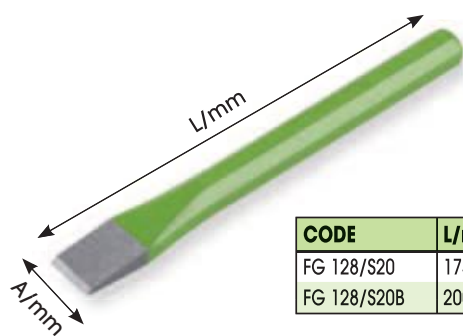

Flat chisel

CODE	L/mm	A/mm	Min.	€/Pz
FG 128/S20	175	20.0	5pz	12,80
FG 128/S20B	200	20.0	5pz	14,00

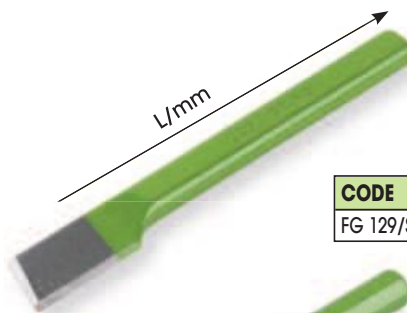
Chisel edge  
with cutting side

CODE	L/mm	Min.	€/Pz
FG 129/S20	200	3pz	11,80



Cape chisel

CODE	L/mm	Ø mm	Min.	€/Pz
FG 128/U5	125	6.0	5pz	7,50

Masonry point

CODE	L/mm	Ø mm	Min.	€/Pz
FG 127/PU1	250	4.0	5pz	11,00
FG 127/PU2	300	6.0	5pz	13,00

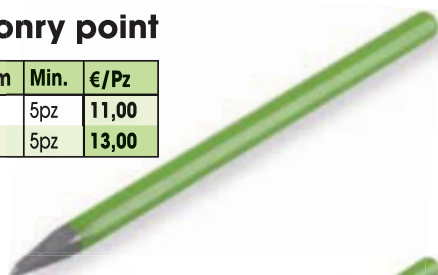
Masonry point  
with safety handle

CODE	gr	L/mm	€/Pz
FG 127/PU2S	300	6.0	20,00

Long construction's chisel

CODE	L/mm	Ø mm	Min.	€/Pz
FG 126/SL1	200	12.0	5pz	7,00
FG 126/SL2	250	12.0	5pz	7,80

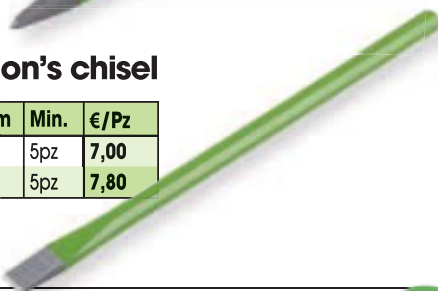
Safety handle  
for masonry point

CODE	INDICATO PER:	€/Pz
FG 127SH/PU2	FG 127/PU2	7,00

Automatic centre punch

CODE	L/mm	Ø mm	Min.	€/Pz
FG 128/BU	120.0	4.0	3pcs	25,00



Centre punch

CODE	L/mm	Ø mm	Min.	€/Pz
FG 128/BU2	134.0	3.0	3pcs	8,00



6pcs set percussion tools

CODE	€/Pz
FG 127/S1	48,00



FG 126/S12, FG 128/S16

FG 126/P4, FG 128/P3

FG 128/BU2

FG 128/U5

Set of 6pcs  
pin punches

- 2,3,4,5,6,8mm

CODE	€/Pz
FG 128C/S6	45,00

Set of 6pcs  
punches

- 1,2,3,4,5,6mm

CODE	€/Pz
FG 128P/S6	40,00



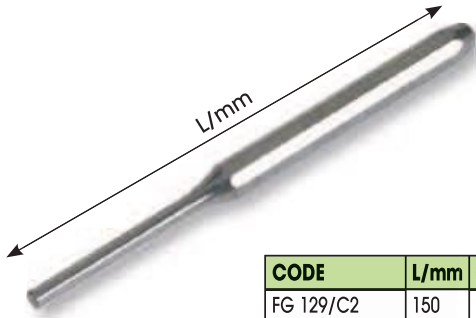

**Pin punch**

CODE	L/mm	Ø/mm	Min.	€/Pz
FG 129/C2	150	2.0	5pz	7,00
FG 129/C3	150	3.0	5pz	7,00
FG 129/C4	150	4.0	5pz	7,50
FG 129/C5	150	5.0	5pz	7,50
FG 129/C6	150	6.0	5pz	8,60
FG 129/C8	150	8.0	5pz	9,20
FG 129/C10	150	10.0	5pz	10,80



**Set of 6pcs  
pin punches**

- 2,3,4,5,6,8mm

CODE	€/Pz
FG 129C/S6	52,00

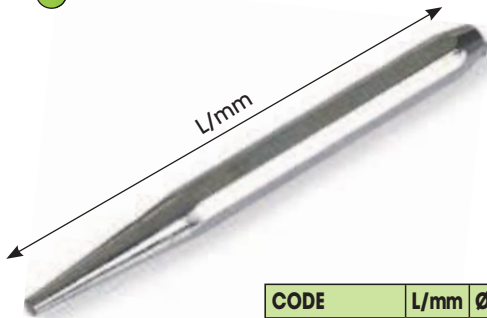

**Punch**

CODE	L/mm	Ø/mm	Min.	€/Pz
FG 129/P1	120	1.0	5pz	6,90
FG 129/P2	120	2.0	5pz	6,90
FG 129/P3	120	3.0	5pz	7,80
FG 129/P4	120	4.0	5pz	7,80
FG 129/P5	120	5.0	5pz	7,80
FG 129/P6	120	6.0	5pz	7,80



**Set of 6pcs  
punches**

- 1,2,3,4,5,6mm

CODE	€/Pz
FG 129P/S6	46,50



**Flat cold chisel**

CODE	L/mm	A/mm	Min.	€/Pz
FG 129/S125	125	14.0	5pz	12,50
FG 129/S150	150	17.0	5pz	15,00
FG 129/S170	175	20.0	5pz	18,50



**Pin punch with  
safety handle**

CODE	L/mm	Ø/mm	Min.	€/Pz
FG 128/CA2	140	2.0	5pz	8,20
FG 128/CA3	149	3.0	5pz	8,20
FG 128/CA4	180	4.0	5pz	9,30
FG 128/CA5	200	5.0	5pz	10,00
FG 128/CA6	210	6.0	5pz	13,40
FG 128/CA7	210	8.0	5pz	13,40
FG 128/CA8	220	6.0	5pz	14,60

*Superior line*



**Set 11pcs percussion  
tools with safety handle**

CODE	CONTENT	€/Pz
FG 128/S11	FG 128/SC12 - FG 128/SC16 FG 128/PU2 - FG 128/PU10	116,00







FASANO  
FC 491TCX

—  
**07**  
—

**CUTTING TOOLS**



# 07 CUTTING TOOLS

## Foldaway knife with trapezoidal blade

Equipped with 3 blades

CODE	L/mm	€/Pz
FG 48/B	110-180	21,00



## 12pcs blades kit

CODE	€/Pz
FG 48/K12	8,00



## Utility knife with long blade

CODE	L/mm	€/Pz
FG 48/L	164	9,00



## 10pcs blades kit

CODE	MM	€/Pz
FG 48/KL10	0.5x18x100	6,00



## Professional pen cutter

Equipped with 3 blades

CODE	L/mm	€/Pz
FG 48/P	142	10,00



## 10pcs blades kit

CODE	€/Pz
FG 48/PL	6,50



## Extra flat cutter with 9mm blade

CODE	L/mm	€/Pz
FG 48/L9	134	7,00



## 10pcs blades kit

CODE	mm	€/Pz
FG 48/KL9	0.4x9x73.4	5,50



## Utility knife with long blade

CODE	L/mm	€/Pz
FG 48/LG	16.7	9,00



## 10pcs blades kit

CODE	MM	€/Pz
FG 48/KL10	0.5x18x100	6,00



## Electricians scissor with entirely Stainless steel body

CODE	L/mm	A/mm	€/Pz
FG 49/TC	140	65mm	39,50

- micro-serrated steel blade
- HRC: 56
- integral stainless steel structure
- 12mm cable cutter
- supplied with belt support

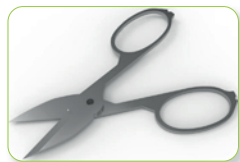

## Electricians scissor with entirely Stainless steel body

CODE	L/mm	A/mm	€/Pz
FG 49/TCX	160	50mm	46,00

- micro-serrated steel blade
- HRC: 56
- integral stainless steel structure
- 12mm cable cutter
- supplied with belt support



## Electrician's scissors

CODE	L/mm	A/mm	€/Pz
FG 49	137	45mm	16,00

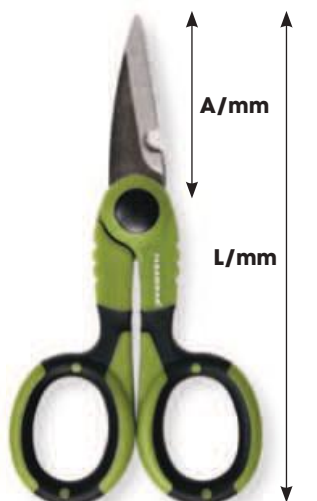

## Multi-purpose scissor with stainless steel blades

CODE	L/mm	A/mm	Max opening	€/Pz
FG 49/L	200	87	151mm	17,00

HRC: 52-54

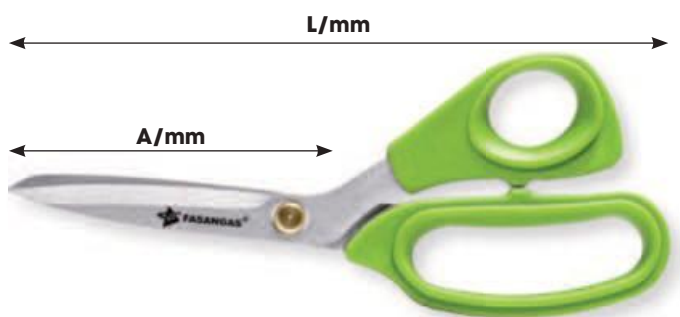

**Multi-purpose scissor with wire stripper and saw-type blades**

CODE	L/mm	Lama	CAPACITY	€/Pz
FG 49/MU	203	52mm	1.0, 1.5, 2.0 mm <sup>2</sup>	<b>26,50</b>

**HRC: 52-54**



**Hose cutter with stainless steel blades**

CODE	L/mm	CAPACITY	€/Pz
FG 77/TT	226	3 - 36mm	<b>9,60</b>

**HRC: 48-52**



RUBBER HOSE



**Tin snips straight wide blades**

CODE	L/mm	STEEL	INOX	€/Pz
FG 49/HE200	200	0.53 mm	0.36 mm	<b>22,00</b>
FG 49/HE250	250	0.78 mm	0.46 mm	<b>25,00</b>
FG 49/HE300	300	0.94 mm	0.78 mm	<b>32,00</b>
FG 49/HE350	350	1.24 mm	0.78 mm	<b>40,00</b>

**HRC: 58-61**



**Compound leverage shears - straight blades**

CODE	L/mm	Max opening	€/Pz
FG 49/CS	252	21mm	<b>27,50</b>

**HRC: 60-62**



STEEL: 0 -1.2mm  
INOX: 0-0.7mm



**Left cut leverage shears -curved blades**

CODE	L/mm	Max opening	€/Pz
FG 49/CL	245	17mm	<b>27,50</b>

**HRC: 60-62**



STEEL: 0 -1.2mm  
INOX: 0-0.7mm



**Right cut leverage shears -curved blades**

CODE	L/mm	Max opening	€/Pz
FG 49/CR	245	17mm	<b>27,50</b>

**HRC: 60-62**



STEEL: 0 -1.2mm  
INOX: 0-0.7mm



**Bolt cutter**

CODE	L/mm -"	CAPACITY'	€/Pz
FG 67/350	350 - 14"	3-10mm	<b>48,00</b>
FG 67/450	450 - 18"	5-16mm	<b>61,00</b>
FG 67/600	600 24"	8-22mm	<b>82,50</b>
FG 67/750	750 - 30"	9-25mm	<b>107,00</b>
FG 67/900	900 - 36"	10-26mm	<b>135,00</b>

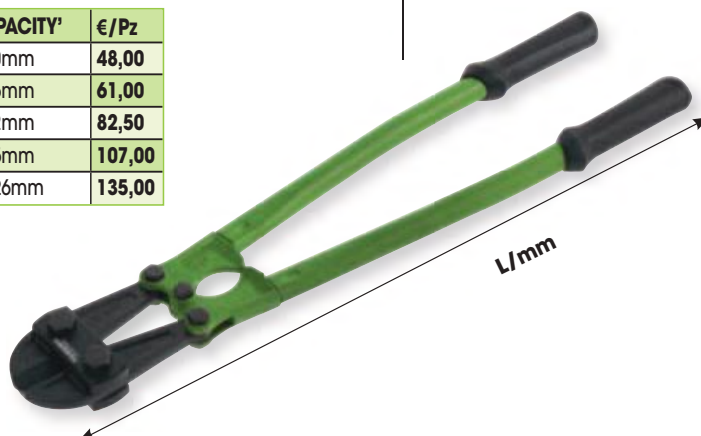

**Blades parts**

CODE	FOR:	€/Pz
FG 67/350R	FG 67/350	<b>21,50</b>
FG 67/450R	FG 67/450	<b>26,00</b>
FG 67/600R	FG 67/600	<b>34,50</b>
FG 67/750R	FG 67/750	<b>48,50</b>
FG 67/900R	FG 67/900	<b>64,50</b>



### Ergonomic hacksaw with HSS Bi-Metal blade

CODE	L/mm	Blade mm	€/Pz
FG 50/ME	402	300	38,00

- adjustable blade  
0° and 40°



### Simple hacksaw with HSS Bi-Metal blade

CODE	L/mm	Blade mm	€/Pz
FG 50/SE	402	300	24,50



### Simple hacksaw with HSS Bi-Metal blade

CODE	L/mm	Blade mm	€/Pz
FG 50/PE	515	300	17,50



### Mini-hacksaw in ABS with Carbon steel blade

CODE	L/mm	Blade mm	€/Pz
FG 50/MS	270	150	7,50

- lama regolabile a 45°, 90°, 135°, 180°



### Mini hacksaw with HSS Bi-Metal blade

CODE	L/mm	Blade	€/Pz
FG 50/MN	405	130mm	12,00



### Blade

CODE	€/Pz
FG 50/MN-B	4,00



### Mini hacksaw with HSS Bi-Metal blade

CODE	L/mm	Blade	€/Pz
FG 50/MI	312	150mm	8,50



### Kit of blades

CODE	L/mm	MATERIAL	CONTENT	FOR	€/Pz
FG 50/MSL	150	Carbon	10pcs	FG 50/MS - FG 50/MI	10,50
FG 50/MIL	300	Carbon	10pcs	FG 50/ME - FG 50/PE	15,00
FG 50/LBM	300	HSS Bi-metal	10pcs	FG 50/SE	27,00



### Rasps with handle

CODE	L/mm	SHAPE	€/Pz
FG 82/RST	200	HALF-ROUND	11,50
FG 82/RP	200	FLAT	11,50



## Second cut files with handle - 8"



CODE	L/mm	SHAPE	€/Pz
FG 80/8AR	200	ROUND	15,00
FG 80/8AM	200	HALF-ROUND	15,00
FG 80/8AP	200	FLAT	16,00
FG 80/8AT	200	TRIANGLE	15,00
FG 80/8AQ	200	SQUARE	17,00

### Set of second cut files

CODE	CUT	CONTENT	€/Pz
FG 80/S5B	SECOND	5pcs	78,00



## Bastard cut files with handle - 8"

CODE	L/mm	SHAPE	€/Pz
FG 81/8AR	200	ROUND	11,50
FG 81/8AM	200	HALF-ROUND	15,00
FG 81/8AP	200	FLAT	14,50
FG 81/8AT	200	TRIANGLE	14,50
FG 81/8AQ	200	SQUARE	14,50

### Set of bastard cut files

CODE	CUT	CONTENT	€/Pz
FG 81/S5B	BASTARD	5pcs	75,00



## Needle files with handle

CODE	L/mm	SHAPE	Minimum q.ty	€/Pz
FG 83/AR	160	ROUND	5pcs	5,00
FG 83/AT	160	TRIANGLE	5pcs	5,00
FG 83/AQ	160	SQUARE	5pcs	5,00
FG 83/AM	160	HALF-ROUND	5pcs	5,00
FG 83/AP	160	FLAT	5pcs	5,00
FG 83/AW	160	WARDING	5pcs	5,00

### Set of needle files with handles in nylon pouch

CODE	€/Pz
FG 83/S6	30,00



## SET OF 3pcs HSS TAPS - COARSE AND METRIC TREAD

DIN 352 - HRC: 63-66



CODE	Ø mm	■ mm	L1mm	L mm	€/Pz
FG 71/M3x0.5	3x0.5	3.5	11	40	12,50
FG 71/M4x0.7	4x0.7	3.5	13	45	12,50
FG 71/M5x0.8	5x0.8	6.0	16	48	14,00
FG 71/M6X1	6X1	6.0	19	50	14,00
FG 71/M7X1	7X1	6.0	19	50	17,00
FG 71/M8X1.25	8X1.25	6.0	22	56	17,00
FG 71/M10x1.5	10x1.5	7.0	24	70	20,00
FG 71/M12X1.75	12X1.75	9.0	29	75	28,00
FG 71/M14X2	14X2	11.0	30	80	39,00
FG 71/M16X2	16X2	12.0	32	80	39,00
FG 71/18x2.5	18x2.5	14.0	40	95	60,00
FG 71/M20X2.5	20X2.5	16.0	40	95	70,00
FG 71/M22X2.5	22X2.5	18.0	40	100	90,00
FG 71/M24X3	24X3	18.0	50	110	110,00

## SET OF 3pcs HSS TAPS - FINE AND METRIC TREAD

DIN 2181 - HRC: 63-66



CODE	Ø mm	■ mm	L1mm	L mm	€/Pz
FG 72/M6x0.75	6x0.75	6.0	19	50	9,00
FG 72/M7X0.75	7X0.75	6.0	19	50	11,00
FG 72/M8X0.75	8X0.75	6.0	22	56	11,00
FG 72/M8X1	8X1	6.0	22	56	11,00
FG 72/M9X1	9X1	7.0	22	63	13,00
FG 72/M10X0.75	10X0.75	7.0	24	70	13,00
FG 72/M10x1	10x1	7.0	24	70	13,00
FG 72/M10X1.25	10X1.25	7.0	24	70	13,00
FG 72/M11X1	11X1	8.0	24	70	18,50
FG 72/M12X1	12X1	9.0	29	75	18,50
FG 72/M12X1.25	12X1.25	9.0	29	75	18,50
FG 72/M12X1.5	12X1.5	9.0	29	75	18,50
FG 72/M13X1.5	13X1.5	9.0	29	75	26,50
FG 72/M14x1	14X1	11.0	30	80	26,50

CODE	Ø mm	■ mm	L1mm	L mm	€/Pz
FG 72/M14X1.25	14X1.25	11.0	30	80	26,50
FG 72/M14X1.5	14X1.5	11.0	30	80	26,50
FG 72/M15X1.5	15X1.5	12.0	32	80	32,00
FG 72/M16X1	16X1	12.0	32	80	32,00
FG 72/M16x1.5	16x1.5	12.0	40	80	32,00
FG 72/M18X1.5	18X1.5	14.0	40	95	40,00
FG 72/M18X2	18X2	14.0	40	95	40,00
FG 72/M20X1.25	20X1.25	16.0	40	95	47,00
FG 72/M20X1.5	20X1.5	16.0	40	95	47,00
FG 72/M20X2	20X2	16.0	40	95	47,00
FG 72/M22X1.5	22X1.5	18.0	40	100	64,00
FG 72/M24X1	24X1	18.0	50	110	64,00
FG 72/M24X1.5	24X1.5	18.0	50	110	75,00
FG 72/M24X2	24X2	18.0	50	110	75,00

### Hand tap holder with zinc cap - Din 1814



CODE	CAPACITY	Ø mm	L/mm	€/Pz
FG 72/GMM0	M1-M8	2÷5mm	130	7,00
FG 72/GMM1	M1-M10	2÷6.3mm	190	8,00
FG 72/GMM1.5	M1-M12	2.1÷8mm	217	8,00
FG 72/GMM2	M4-M12	3÷9mm	280	15,00
FG 72/GMM3	M5-M20	4.9÷12mm	380	24,50
FG 72/GMM4	M9-M27	5.5÷16mm	500	31,00
FG 72/GMM5	M13-M32	7÷18mm	700	40,00

### Ratchet tap holder - short model

CODE	M	BSW	L/mm	€/Pz
FG 72/GMC1	M3-M10	1/8-3/8	85	17,50
FG 72/GMC2	M5-M12	7/32-1/2	85	22,00

### Ratchet tap holder - long model

CODE	M	BSW	L/mm	€/Pz
FG 72/GMC3	M3-M10	1/8-3/8	300	28,00
FG 72/GMC4	M5-M12	7/32-1/2	300	34,00



## HSS DIE - COARSE AND METRIC TREAD



**DIN223**  
**HRC: 63-65**

CODE	Ø mm	€/Pz	CODE	Ø mm	€/Pz
FG 73/M3x0.5	20x5	9,00	FG 73/M12X1.75	38x14	21,50
FG 73/M4x0.7	20x5	9,00	FG 73/M14X2	38x14	21,50
FG 73/M5x0.8	20x7	9,00	FG 73/M16X2	45x18	33,00
FG 73/M6x1	20x7	9,00	FG 73/M18X2.5	45x18	33,00
FG 73/M7X1	25x9	12,00	FG 73/M20X2.5	45x18	33,00
FG 73/M8X1.25	25x9	12,50	FG 73/M22X2.5	55x22	50,00
FG 73/M10X1.5	30x11	19,00	FG 73/M24X3	55x22	50,00

## HSS DIE - FINE AND METRIC TREAD

**DIN223 - HRC: 63-65**



CODE	Ø mm	€/Pz	CODE	Ø mm	€/Pz	CODE	Ø mm	€/Pz
FG 74/M6x0.75	20X7	9,00	FG 74/M11X0.75	30X11	18,50	FG 74/M18x1.5	45x14	46,00
FG 74/M7X0.5	25X9	12,00	FG 74/M11X1	30X11	18,50	FG 74/M20x1.25	45x14	46,00
FG 74/M8X0.75	25x9	12,00	FG 74/M12X0.75	38X14	31,00	FG 74/M20x1.5	45x14	46,00
FG 74/M8X1	25x9	12,00	FG 74/M12X1	38X14	31,00	FG 74/M20x2	45x14	46,00
FG 74/M9X0.75	25x9	12,00	FG 74/M12x1.25	38x14	31,00	FG 74/M21x1.5	45x14	46,00
FG 74/M9X1	25x9	12,00	FG 74/M12x1.5	38x14	31,00	FG 74/M22x1.5	55x16	73,00
FG 74/M9X1.25	25X9	12,00	FG 74/M14x1	38x14	31,00	FG 74/M24x1	55x16	73,00
FG 74/M10X0.5	30X11	18,50	FG 74/M14x1.25	38x14	31,00	FG 74/M24x1.5	55X16	73,00
FG 74/M10X0.75	30X11	18,50	FG 74/M14x1.5	38x14	31,00	FG 74/M24x2	55X16	73,00
FG 74/M10X1	30x11	18,50	FG 74/M15x1	38x14	31,00			
FG 74/M10X1.25	30X11	18,50	FG 74/M16x1	45x14	46,00			
FG 74/M11X0.5	30X11	18,50	FG 74/M16x1.5	45x14	46,00			



**Die holder**

**DIN225**

CODE	Ø mm	L/mm	€/Pz
FG 74/GF16x5	16x5	160	6,60
FG 74/GF20x5	20x5	200	6,60
FG 74/GF20x7	20x7	200	6,60
FG 74/GF25x9	25x9	224	7,50
FG 74/GF30x11	30x11	280	10,00
FG 74/GF38x14	38x14	315	18,50
FG 74/GF45x18	45x18	450	26,00
FG 74/GF55x22	55x22	560	26,00
FG 74/GF65x25	65x25	630	34,00

## Combined drill for drilling-threading-deburring

with 1/4" hexagon drive

**HSS**



CODE	Ø mm	L/mm	€/Pz
FG 74/PM3x0.5	3x0.5	36	18,50
FG 74/PM4x0.7	4x0.7	39	18,50
FG 74/PM5x0.8	5x0.8	41	18,50
FG 74/PM6x1	6x1	44	18,50
FG 74/PM8x1.25	8x1.25	50	20,50
FG 74/PM10x1.5	10x1.5	59	21,00

## Set of combined drills + accessory

CODE	CONTENT	€/Pz
FG 74PM/S7	M3 - M10	118,00







## Set of 110pcs taps, dies and accessories

### Coarse and fine thread

						ACCESSOIRES
2x0.4	6x0.75	12x1	2x0.4	6x0.75	12x1	GF25x9
3x0.5	7x0.75	12x1.25	3x0.5	7x0.75	12x1.25	GF8x14
4x0.7	8x0.75	12x1.5	4x0.7	8x0.75	12x1.5	GMM1.5
5x0.8	8x1	14x1	5x0.8	8x1	14x1	GMM3
6x1	9x0.75	14x1.25	6x1	9x0.75	14x1.25	GMC1
7x1	9x1	14x1.5	7x1	9x1	14x1.5	
8x1.25	10x0.75	16x1	8x1.25	10x0.75	16x1	
9x1.25	10x1	16x1.5	9x1.25	10x1	16x1.5	
10x1.5	10x1.25	18x1.5	10x1.5	10x1.25	18x1.5	
11x1.5	11x0.75	11x1.5	11x1.5	11x0.75		
12x1.75	11x1	12x1.75	12x1.75	11x1		
14x2	11x1.25	14x2	11x1.25			
16x2	12x0.75	16x2	12x0.75			

CODE	€/Pz
FG 70/S110	335,00



## SET OF 65pcs HSS TAPS + ACCESSORIES

### COARSE AND FINE TREAD / METRIC TREAD

FG 71/M...	FG 72/M...	FG 73/M...	FG 74/M...	ACCESSOIRES
3 x 0.5	6 x 0.75	3 x 0.5	10 x 1.25	FG 72/GMM1.5
4 x 0.7	8 x 1	4 x 0.7	12 x 1.5	FG 72/GMM3
6 x 1	10 x 1.25	5 x 0.8	14 x 1.5	FG 72/GMC1
7 x 1	12 x 1.5	6 x 1	16 x 1.5	FG 72/GMC2
8 x 1.25	14 x 1.5	7 x 1	18 x 1.5	FG 74/GF25x9
10 x 1.5	16 x 1.5	8 x 1.25		FG 74/GF45x18
12 x 1.75	18 x 1.5	10 x 1.5		
14 x 2				
16 x 2				
18 x 2.5				
20 x 2.5				

CODE	€/Pz
FG 70/S65	560,00



### Hss tube drills

CODE	Ø mm	L/mm	€/Pz
FG 80HSS/1	3 - 14	58	22,00
FG 80HSS/2	6 - 20	70	40,00
FG 80HSS/3	16 - 30.5	75	75,00



### Set of 4pcs HSS tube drills

CODE	CONTENUTO	€/Pz
FG 80HSS/S3	3 - 14 mm 6 - 20 mm 16 - 30.5 mm	145,00

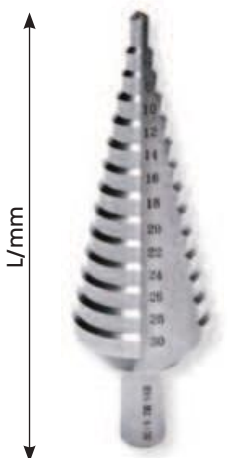

### Hss step drills

CODE	Ømm	L/mm	S/mm	€/Pz
FG 81HSS/1	4 - 12	65	1	44,00
FG 81HSS/2	4 - 20	75	2	62,00
FG 81HSS/3	4 - 30	100	2	135,00



### Set of 4pcs HSS step drills

CODE	CONTENT	€/Pz
FG 81HSS/S3	3 - 12 mm 4 - 20 mm 4 - 30 mm	240,00



### Rotary file for hard metal HM4

CODE	Ø/mm	L2/mm	L1/mm	€/Pz
FG 80MD/ET3	3.0	16.0	38.0	13,00
FG 80MD/ET6	6.0	18.0	50.0	39,00
FG 80MD/ET12.7	6.0	25.0	70.0	68,00

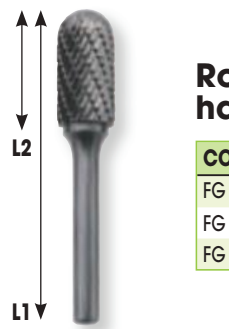

### Rotary file for hard metal HM4

CODE	Ø/mm	L2/mm	L1/mm	€/Pz
FG 80MD/ER3	3.0	16.0	38.0	13,00
FG 80MD/ER6	6.0	18.0	50.0	39,00
FG 80MD/ER12.7	6.0	25.0	70.0	68,00



### Rotary file for hard metal HM4

CODE	Ø/mm	L2/mm	L1/mm	€/Pz
FG 80MD/SV3	3.0	16.0	38.0	13,00
FG 80MD/SV6	6.0	18.0	50.0	39,00
FG 80MD/SV12.7	6.0	25.0	70.0	68,00

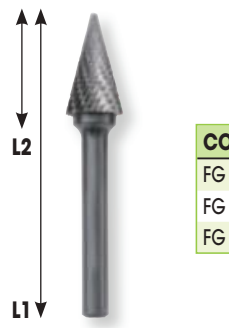

### Rotary file for hard metal HM4

CODE	Ø/mm	L2/mm	L1/mm	€/Pz
FG 80MD/EC3	3.0	16.0	38.0	13,00
FG 80MD/EC6	6.0	18.0	50.0	39,00
FG 80MD/EC12.7	6.0	25.0	70.0	68,00



### Rotary file for hard metal HM4

CODE	Ø/mm	L2/mm	L1/mm	€/Pz
FG 80MD/CS3	3.0	3.0	38.0	13,00
FG 80MD/CS6	6.0	5.0	50.0	39,00
FG 80MD/CS12.7	6.0	10.0	70.0	68,00

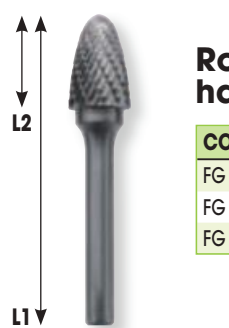

### Rotary file for hard metal HM4

CODE	Ø/mm	L2/mm	L1/mm	€/Pz
FG 80MD/AR3	3.0	16.0	38.0	13,00
FG 80MD/AR6	6.0	18.0	50.0	39,00
FG 80MD/AR12.7	6.0	25.0	70.0	68,00



## HSS Bi-Metal hole saws

Max cutting capacity: 38mm  
HRC: 60



APPLICATIONS



CODE	Ømm	Inch.	H/ mm	RPM					€/Pz
				Steel	inox	Cast steels	Brass	Alum.	
FG 78/HSS14	14	9/16"	45	580	300	400	790	900	8,40
FG 78/HSS16	16	5/8"	45	550	275	365	730	825	8,40
FG 78/HSS17	17	11/16"	45	500	250	330	665	750	8,40
FG 78/HSS19	19	3/4"	45	460	230	300	600	690	8,40
FG 78/HSS20	20	25/32"	45	425	210	280	560	635	8,40
FG 78/HSS21	21	13/16"	45	425	210	280	560	635	8,60
FG 78/HSS22	22	7/8"	45	390	195	260	520	585	8,60
FG 78/HSS24	24	15/16"	45	370	185	245	495	555	8,60
FG 78/HSS25	25	1"	45	350	175	235	470	525	8,70
FG 78/HSS27	27	1.1/16"	45	325	160	215	435	480	8,80
FG 78/HSS28	28	1.1/16"	45	300	150	200	400	450	8,80
FG 78/HSS29	29	1.1/8"	45	300	150	200	400	450	8,80
FG 78/HSS30	30	1.3/16"	45	285	145	190	380	425	9,00
FG 78/HSS32	32	1.1/4"	45	275	140	180	360	410	9,60
FG 78/HSS33	33	1.5/16"	45	260	135	175	345	390	9,90
FG 78/HSS35	35	1.3/8"	45	250	125	165	330	375	10,50
FG 78/HSS37	37	1.7/16"	45	240	120	160	315	360	11,00
FG 78/HSS38	38	1.1/2"	45	230	115	150	300	345	11,00
FG 78/HSS40	40	1.9/16"	45	220	110	145	290	330	11,20
FG 78/HSS41	41	1.5/8"	45	210	105	140	280	315	11,50
FG 78/HSS43	43	1.11/16"	40	205	100	135	270	305	11,50
FG 78/HSS44	44	1.3/4"	40	195	95	130	260	295	11,70
FG 78/HSS46	46	1.13/16"	40	190	95	125	250	285	11,70
FG 78/HSS48	48	1.7/8"	40	180	90	120	240	270	11,70
FG 78/HSS50	50	2"	40	170	85	115	230	255	12,40
FG 78/HSS51	51	2.1/16"	40	165	80	110	220	245	12,40
FG 78/HSS52	52	2.1/16"	40	165	80	110	220	245	12,40
FG 78/HSS54	54	2.1/8"	40	160	80	105	210	240	13,50

CODE	Ømm	Inch.	H/ mm	RPM					€/Pz
				Steel	inox	Cast steels	Brass	Alum.	
FG 78/HSS57	57	2.1/4"	40	150	75	100	200	225	13,90
FG 78/HSS59	59	2.5/16"	40	145	75	100	195	225	13,90
FG 78/HSS60	60	2.3/8"	40	140	70	95	190	220	14,50
FG 78/HSS64	64	2.1/2"	40	135	65	90	180	205	14,60
FG 78/HSS65	65	2.9/16"	40	130	65	85	175	200	15,00
FG 78/HSS67	67	2.5/8"	40	130	65	85	170	195	15,30
FG 78/HSS68	68	2.11/16"	40	130	65	85	170	195	15,30
FG 78/HSS70	70	2.3/4"	40	125	60	80	160	185	16,20
FG 78/HSS73	73	2.7/8"	40	120	60	80	160	180	16,50
FG 78/HSS76	76	3"	40	115	55	75	150	170	17,30
FG 78/HSS79	79	3.1/8"	40	110	55	70	140	165	18,40
FG 78/HSS83	83	3.1/4"	40	105	50	70	140	155	21,00
FG 78/HSS86	86	3.3/8"	40	100	50	65	130	150	21,50
FG 78/HSS89	89	3.1/2"	40	95	45	65	130	145	22,00
FG 78/HSS92	92	3.5/8"	40	95	45	60	120	140	23,00
FG 78/HSS95	95	3.3/4"	40	90	45	60	120	135	24,00
FG 78/HSS98	98	3.7/8"	40	90	45	60	120	135	25,00
FG 78/HSS102	102	4"	40	85	40	55	110	130	27,00
FG 78/HSS105	105	4.1/8"	40	80	40	55	110	120	28,50
FG 78/HSS108	108	4.1/4"	40	80	40	55	110	120	29,50
FG 78/HSS111	111	4.3/8"	40	80	40	50	100	120	31,00
FG 78/HSS114	114	4.1/2"	40	75	35	50	100	105	33,00
FG 78/HSS121	121	4.3/4"	40	70	35	45	95	95	35,00
FG 78/HSS127	127	5"	40	65	30	45	90	90	36,00
FG 78/HSS133	133	5.1/4"	40	60	25	40	85	85	39,00
FG 78/HSS140	140	5.1/2"	40	60	25	40	85	85	42,00
FG 78/HSS146	146	5.3/4"	40	60	25	40	85	85	44,00
FG 78/HSS152	152	6"	40	55	25	35	75	75	48,00

## Arbors for hole saws

CODE	FOR:	L/mm	€/Pz
FG 78/AL14	16 - 30 mm	54	18,00
FG 78/AL12	35 - 152 mm	70	35,00



## Spring for hole saw

CODE	Ø mm	L/mm	€/Pz
FG 78/PC1	6.35	102.0	8,00



## Hss pilot drill

CODE	L/mm	€/Pz
FG 78/SP1	40.0	2,50



## Hss pilot drill

CODE	L/mm	€/Pz
FG 78/PR1	300.0	21,00





**Set of 9pcs hole saws + accessories**

	CONTENT	mm
01x	FG 78/HSS...	19, 22, 29, 35, 38, 44, 51, 57, 64
01x	FG 78/AL14	16 - 30mm
01x	FG 78/AL12	32 - 152mm

CODE	€/Pz
FG 78HSS/S12	<b>220,00</b>



**Set of 12pcs hole saws + accessories**

CODE	CONTENT	mm	€/Pz
FG 78HSS/S17	FG 78/HSS...	19, 22, 29, 35, 38, 44, 50, 51, 57, 64, 76, 83	<b>300,00</b>
	FG 78/AL14	16 - 30	
	FG 78/AL12	35 - 152	
	FG 78/PR1	300.0	
	FG 78/PC1	102x6.35	
	FG 78/SP1	40.0	

**Grinding pencil - 6mm**

CODE	Ø/mm	L2/mm	L1/mm	€/Pz
FGA 338/MO1	6.0	50	20	<b>6,00</b>
FGA 338/MO2	6.0	63	36	<b>6,00</b>

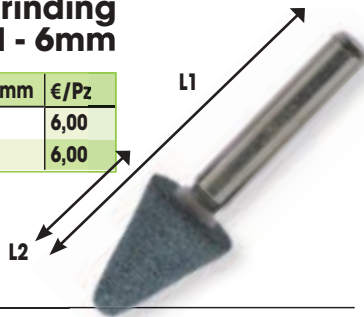

**Grinding pencil - 6mm**

CODE	Ø/mm	L2/mm	L1/mm	€/Pz
FGA 338/MO3	6.0	45	11	<b>6,00</b>
FGA 338/MO4	6.0	50	25	<b>6,00</b>

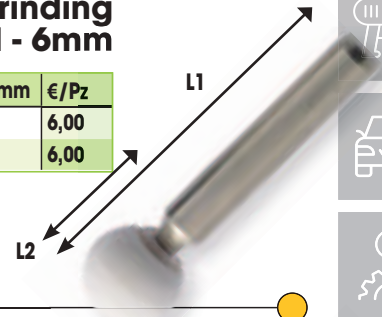

**Grinding pencil - 6mm**

CODE	Ø/mm	L2/mm	L1/mm	€/Pz
FGA 338/MO5	6.0	53	26	<b>6,00</b>
FGA 338/MO6	6.0	53	25	<b>6,00</b>
FGA 338/MO7	6.0	53	25	<b>6,00</b>

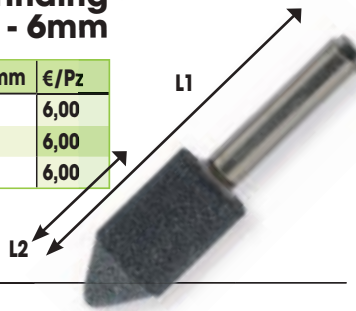

**Grinding pencil - 6mm**

CODE	Ø/mm	L2/mm	L1/mm	€/Pz
FGA 338/MO10	6.0	45	15	<b>6,00</b>

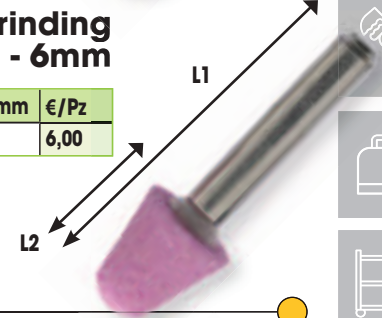

**Grinding pencil - 6mm**

CODE	Ø/mm	L1/mm	L2/mm	Ø/mm	€/Pz
FGA 338/MO8	6.0	45	13	25	<b>6,00</b>
FGA 338/MO9	6.0	45	15	10	<b>6,00</b>

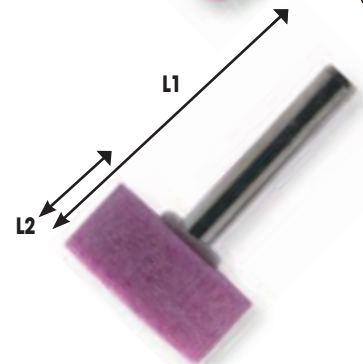



## Twist HSS drills with cylindrical shank - DIN 338

CODE	Ømm	Mn. q.ty	€/Pz	CODE	Ømm	Mn. q.ty	€/Pz
FG 75/HSS0.5	0.5	10	1,80	FG 75/HSS6.75	6.75	10	4,20
FG 75/HSS1	1.0	10	1,40	FG 75/HSS7	7	10	4,60
FG 75/HSS1.25	1.25	10	1,40	FG 75/HSS7.5	7.5	10	3,20
FG 75/HSS1.5	1.5	10	1,20	FG 75/HSS8	8.0	10	2,80
FG 75/HSS1.75	1.75	10	1,20	FG 75/HSS8.5	8.5	10	3,80
FG 75/HSS2	2.0	10	1,10	FG 75/HSS9	9.0	10	3,50
FG 75/HSS2.25	2.25	10	1,30	FG 75/HSS6.75	6.75	10	4,20
FG 75/HSS2.5	2.5	10	1,20	FG 75/HSS7	7.0	10	4,60
FG 75/HSS2.75	2.75	10	1,80	FG 75/HSS7.5	7.5	10	4,20
FG 75/HSS3	3.0	10	1,40	FG 75/HSS8	8.0	10	5,10
FG 75/HSS3.1	3.1	10	1,60	FG 75/HSS8.5	8.5	10	6,20
FG 75/HSS3.2	3.2	10	1,80	FG 75/HSS9	9.0	10	6,50
FG 75/HSS3.25	3.25	10	1,60	FG 75/HSS9.5	9.5	10	6,70
FG 75/HSS3.5	3.5	10	1,50	FG 75/HSS10	10.0	10	7,50
FG 75/HSS3.75	4.0	10	1,90	FG 75/HSS10.5	10.5	10	9,00
FG 75/HSS4.0	4.0	10	1,70	FG 75/HSS11	11.0	10	11,00
FG 75/HSS4.1	4.1	10	2,00	FG 75/HSS11.5	11.5	10	11,50
FG 75/HSS4.2	4.2	10	2,00	FG 75/HSS12	12.0	10	12,50
FG 75/HSS4.25	4.25	10	2,10	FG 75/HSS12.5	12.5	05	13,50
FG 75/HSS4.5	4.5	10	1,90	FG 75/HSS13	13.0	05	14,50
FG 75/HSS4.75	4.75	10	2,30	FG 75/HSS14	14.0	05	22,00
FG 75/HSS5	5.0	10	2,00	FG 75/HSS15	15.0	05	27,00
FG 75/HSS5.1	5.1	10	2,70	FG 75/HSS16	16.0	05	31,00
FG 75/HSS5.25	5.25	10	3,00	FG 75/HSS17	17.0	04	37,00
FG 75/HSS5.5	5.5	10	2,70	FG 75/HSS18	18.0	04	44,00
FG 75/HSS6	6	10	2,80	FG 75/HSS19	19.0	04	47,00
FG 75/HSS6.25	6.25	10	3,80	FG 75/HSS20	20.0	04	54,00
FG 75/HSS6.5	6.5	10	3,50				



CODE	Ømm	Mn. q.ty	€/Pz	CODE	Ømm	Mn. q.ty	€/Pz
FG 76/HSS14	14.0	05	22,00	FG 76/HSS17	17.0	04	34,00
FG 76/HSS15	15.0	05	26,00	FG 76/HSS18	18.0	04	40,00
FG 76/HSS16	16.0	05	29,00	FG 76/HSS19	19.0	04	42,00
				FG 76/HSS20	20.0	04	48,00



## Twist HSS-Tin 5% drills with cylindrical shank - DIN 338

CODE	Ømm	Mn. q.ty	€/Pz	CODE	Ømm	Mn. q.ty	€/Pz
FG 75/TIN0.5	0.5	10	1,70	FG 75/TIN7	7.0	109	5,10
FG 75/TIN1	1.0	10	1,70	FG 75/TIN7.5	7.5	10	6,30
FG 75/TIN1.5	1.5	10	1,40	FG 75/TIN8	8.0	10	7,30
FG 75/TIN2	2.0	10	1,60	FG 75/TIN8.5	8.5	10	9,00
FG 75/TIN2.5	2.5	10	1,70	FG 75/TIN9	9.0	10	9,80
FG 75/TIN3	3.0	10	2,10	FG 75/TIN9.5	9.5	10	11,00
FG 75/TIN3.5	3.5	10	2,30	FG 75/TIN10	10.0	10	11,30
FG 75/TIN4	4.0	10	2,40	FG 75/TIN10.5	10.5	10	12,60
FG 75/TIN4.5	4.5	10	2,80	FG 75/TIN11	11.0	10	13,50
FG 75/TIN5	5.0	10	3,20	FG 75/TIN11.5	11.5	10	14,80
FG 75/TIN5.5	5.5	10	3,80	FG 75/TIN12	12.0	05	15,50
FG 75/TIN6	6.0	10	4,20	FG 75/TIN12.5	12.5	05	17,00
FG 75/TIN6.5	6.5	10	4,60	FG 75/TIN13	13.0	05	19,00

## Set of 25pcs HSS drills - Entirely ground glossy

Ø/mm: 1-13mm

CODE	€/Pz
FG 75HSS/S25	135,00



## Set of 25pcs HSS drills - Rolled version

Ø/mm: 1-13mm

CODE	€/Pz
FG 75/S25	75,00

## Set of 170pcs HSS drills - Rolled version

Ø/mm: 1-10mm

CODE	€/Pz
FG 75/S170	250,00



## Set of HSS-TIN 5% drills - Entirely ground glossy

CODE	Pz	CONTENT	€/Pz
FG 75TIN/S13	13	1 - 6.5 x0,5mm	58,00
FG 75TIN/S19	19	1 - 10 x0,5mm	90,00
FG 75TIN/S25	25	1 - 13 x0,5mm	185,00





### Twist HSS-Co 5% drills with cylindrical shank - DIN 338

CODE	Ømm	Min. Q.ty	€/Pz	CODE	Ømm	Min. Q.ty	€/Pz
FG 75/CO0.5	0.5	10	4,20	FG 75/CO7	7.0	10	10,30
FG 75/CO1	1.0	10	2,70	FG 75/CO7.5	7.5	10	12,30
FG 75/CO1.5	1.5	10	2,70	FG 75/CO8	8.0	10	13,30
FG 75/CO2	2.0	10	2,70	FG 75/CO8.5	8.5	10	13,50
FG 75/CO2.5	2.5	10	2,80	FG 75/CO9	9.0	10	17,50
FG 75/CO3	3.0	10	2,80	FG 75/CO9.5	9.5	10	18,50
FG 75/CO3.5	3.5	10	3,60	FG 75/CO10	10.0	10	21,50
FG 75/CO4	4.0	10	4,20	FG 75/CO10.5	10.5	10	25,00
FG 75/CO4.5	4.5	10	4,90	FG 75/CO11	11.0	10	28,00
FG 75/CO5	5.0	10	4,90	FG 75/CO11.5	11.5	10	30,00
FG 75/CO5.5	5.5	10	6,70	FG 75/CO12	12.0	05	33,50
FG 75/CO6	6.0	10	7,20	FG 75/CO12.5	12.5	05	36,00
FG 75/CO6.5	6.5	10	8,50	FG 75/CO13	13.0	05	40,00



### Set of HSS-Co 5% drills - Entirely ground glossy

CODE	Pz	CONTENT	€/Pz
FG 75CO/S19	19	1 - 10 x0,5mm	110,00
FG 75CO/S25	25	1 - 13 x0,5mm	230,00



### Mini tube cutter

Ø: 3-16mm, 1/8"-5/8"

CODE	€/Pz
FG 76/R1	15,00

### Tube cutter

Ø: 3-35mm, 1/8"-1.3/8"

CODE	€/Pz
FG 76/R3	40,00



### Tube cutter

Ø: 3-32mm, 1/8"-1.1/4"

CODE	€/Pz
FG 76/R2	24,50

### Pipe cutter for PVC hoses

Ø: 0-35mm

CODE	€/Pz
FG 77/PVC1	34,00



### Adjustable selflocking cutting pliers

Ø/max: 90mm

CODE	€/Pz
FG 69/PC	85,00

### Pipe cutter for PVC hoses

Ø: 0-42mm

CODE	€/Pz
FG 77/PVC3	24,00



### Pipe cutter for PVC hoses

Ø: 0-43mm

CODE	€/Pz
FG 77/PVC5	56,00

### Pipe cutter for PVC hoses

- rack system with progressive advancement
- equipped with a nylon platform that facilitates flat profile cutting
- Ø: 0-42mm

CODE	€/Pz
FG 77/PVC4	70,00

### Replacement blade

CODE	€/Pz
FG 77/PVC4-R	30,00

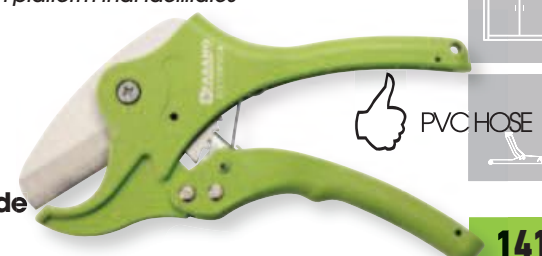



**FASANO**  
TOOLS

# 08

**PULLERS**





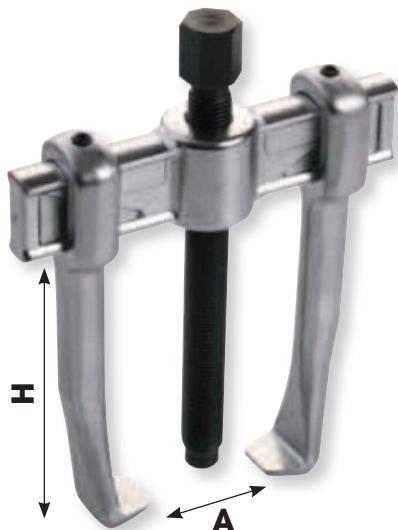

## 2 jaws puller

- Sliding jaws with screw locking
- External hooking
- Chrome vanadium steel jaws
- Chrome Vanadium steel screw

CODE	A/mm	H/mm	€/Pz
FG 162/1	15 - 85mm	100 mm	90,00
FG 162/2	15 - 125mm	100 mm	95,00
FG 162/3	20 - 160mm	150 mm	168,00
FG 162/4	20 - 200mm	150mm	195,00
FG 162/5	40 - 250mm	200mm	295,00

## Set of 3pcs jaws pullers

Content: FG 162/1, FG 162/2, FG 162/3

CODE	€/Pz
FG 162/S3	355,00



## Jaw of replacement for FG 162/1-FG 162/5

CODE	FOR:	€/Pz
FG 162/1-G1	FG 162/1	28,00
FG 162/2-G2	FG 162/2	29,00
FG 162/3-G3	FG 162/3	50,00
FG 162/4-G4	FG 162/4	52,00
FG 162/5-G4	FG 162/5	70,00



## Screw of replacement for FG 162/1-FG 162/5

CODE	FOR:	€/Pz
FG 162/1-V1	FG 162/1	26,00
FG 162/2-V2	FG 162/2	26,00
FG 162/3-V3	FG 162/3	32,00
FG 162/4-V4	FG 162/4	32,00
FG 162/5-V5	FG 162/5	42,00



## 2 thin jaws puller

- Internal and External hooking
- Super thin interchangeable jaws in chrome vanadium steel
- Griff thickness: 2mm
- Chrome Vanadium steel screw

CODE	A/mm	B/mm	C/mm	€/Pz
FG 168/EF1	110	140	186	310,00
FG 168/EF2	195	140	186	320,00

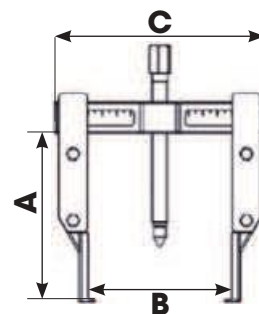

## Jaw of replacement for FG 168/EF1-FG 168/EF2

CODE	FOR:	€/Pz
FG 168/EF1-G1	FG 168/EF1	110,00
FG 168/EF2-G2	FG 168/EF2	115,00



## Screw of replacement for FG 168/EF1-FG 168/EF2

CODE	FOR:	€/Pz
FG 168/EF1-V1	FG 168/EF1	52,00
FG 168/EF2-V1	FG 168/EF2	62,00

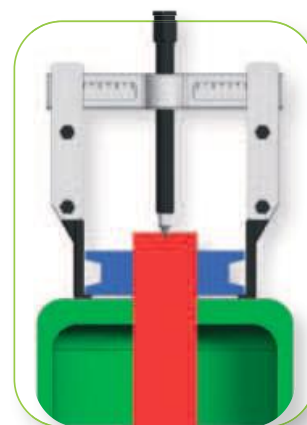

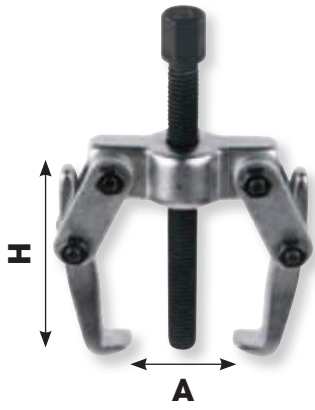

**Small puller with 2 floating jaws**

- Chrome vanadium steel jaws
- Chrome Vanadium steel screw

CODE	A/mm	H/mm	€/Pz
FG 162/ME	60 mm	85mm	32,50

**2 jaws puller - scissor type**

- External hooking
- Chrome vanadium steel adjustable jaws
- Chrome Vanadium steel screw

CODE	A/mm	B/mm	C/mm	D/mm	€/Pz
FG 162/FR1	90	55	90	95	145,00
FG 162/FR2	125	70	120	125	190,00
FG 162/FR3	125	80	160	125	230,00

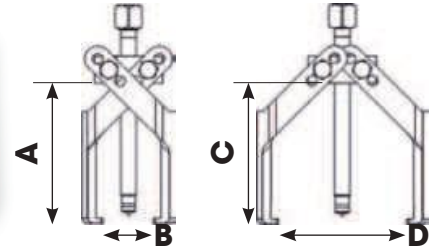

**Outside puller with self-adjustable jaws**

- External hooking
- Chrome vanadium steel adjustable jaws
- Chrome Vanadium steel screw
- Can also be used with jaws for internal grip (see codes FG 164 /GR)

CODE	∅ / mm	€/Pz
FG 163/1	7 - 140	195,00
FG 163/3	20 - 260	270,00

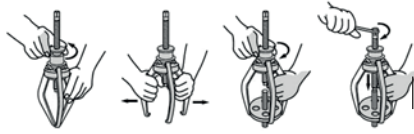

**Jaw of replacement for FG 163/1-FG 163/3**

CODE	FOR:	€/Pz
FG 163/1-GR1	FG 163/1	24,00
FG 163/3-GR3	FG 163/3	33,00



**Screw of replacement for FG 163/1-FG 163/3**

CODE	FOR:	€/Pz
FG 163/1-V1	FG 163/1	29,50
FG 163/3-V3	FG 163/3	38,50



**Inside puller with self-adjustable jaws**

- Internal hooking
- Chrome vanadium steel adjustable jaws
- Chrome Vanadium steel screw
- Can also be used with jaws for external grip (see codes FG 163/GR)

CODE	∅ / mm	€/Pz
FG 164/1	23 - 130	190,00
FG 164/2	50 - 170	235,00

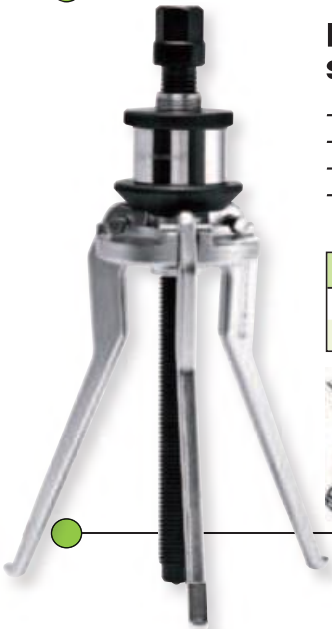

**Jaw of replacement for FG 164/1-FG 164/2**

CODE	FOR:	€/Pz
FG 164/1-GR1	FG 164/1	20,00
FG 164/2-GR2	FG 164/2	25,00



**Screw of replacement for FG 164/1-FG 164/2**

CODE	FOR:	€/Pz
FG 163/1-V1	FG 164/1	29,50
FG 163/2-V2	FG 164/3	38,50



**Set of inside puller + jaws for external hooking**

CODE	∅/mm	€/Pz
FG 163/S2B	7 - 140 per presa esterna 50 - 170 per presa interna	255,00

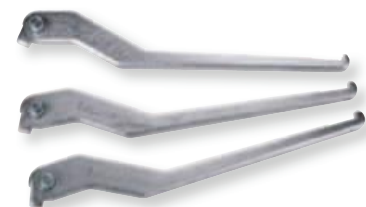



### Self centering puller

- 4 different positions
- External hooking
- Self centering system
- Special design jaws

CODE	A/mm	B/mm	€/Pz
FG 165/1	120	125	290,00
FG 165/2	210	220	360,00
FG 165/3	270	280	540,00

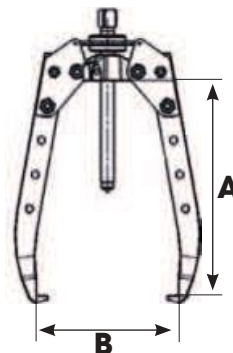

### Self centering hydraulic puller

- 4 different positions
- External hooking
- Self centering system
- Special design jaws

CODE	A/mm	B/mm	C/mm	€/Pz
FG 165/HI	270	280	4.5	950,00

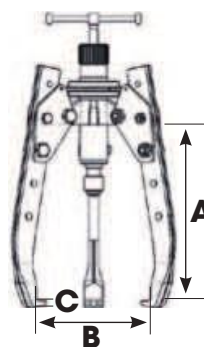

### Jaw of replacement for FG 165/1-FG 165/3 & FG 165/HI

CODE	FOR:	€/Pz
FG 165/1-G1	FG 165/1	33,00
FG 165/2-G2	FG 165/2	44,00
FG 165/3-G3	FG 165/3	64,00
FG 165/HI-G1	FG 165/HI	64,00



### Screw of replacement for FG 165/1-FG 165/3

CODE	FOR:	€/Pz
FG 165/1-V1	FG 165/1	25,00
FG 165/2-V2	FG 165/2	38,00
FG 165/3-V3	FG 165/3	52,00

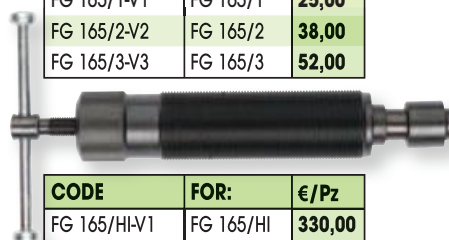

CODE	FOR:	€/Pz
FG 165/HI-V1	FG 165/HI	330,00

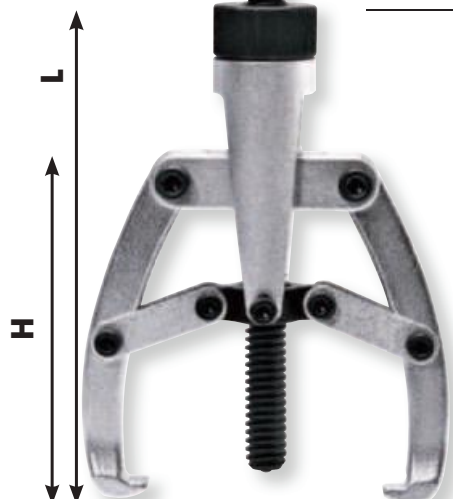

### Heavy duty outside puller with 2 jaws

- External hooking
- The levers supporting each jaw multiply the power guaranteeing high strength levels

CODE	CAPACITY	Opening min-max	AxBxC/mm	HxL/mm	€/Pz
FG 160/1	2 Ton.	20 - 115mm	8x6x15	80x120	105,00
FG 160/2	5Ton.	30 - 240mm	11x10x25	160x250	235,00
FG 160/3	10Ton.	40 - 380mm	14x10x29	230x380	420,00



## Heavy duty outside puller with 3 jaws

- External hooking
- The levers supporting each jaw multiply the power guaranteeing high strength levels

CODE	CAPACITY	Opening min-max	AxBxC/mm	HxL/mm	€/Pz
FG 161/1	2Ton.	28 - 112mm	8x6x15	80x120	<b>120,00</b>
FG 161/2	5Ton.	40 - 243mm	11x10x25	160x250	<b>250,00</b>
FG 161/3	10Ton.	46 - 370mm	14x10x29	230x380	<b>460,00</b>

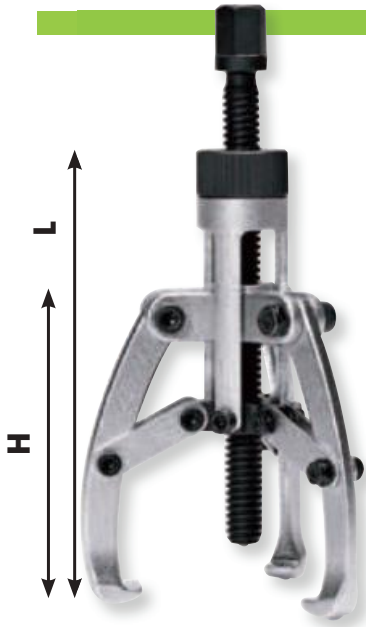

## 2/3 jaws puller

- Supplied with 3 jaws for internal hooking and 3 jaws for external hooking
- Chrome vanadium steel jaws

CODE	∅ internal	∅ external	€/Pz
FG 165/IE1	25-100mm	0-75mm	<b>310,00</b>
FG 165/IE2	45-150mm	40-130mm	<b>740,00</b>



## Slide hammer

- M12 X 1.5

CODE	FOR:	€/Pz
FG 165/MB1	FG 165/IE1	<b>165,00</b>
FG 165/MB2	FG 165/IE2	<b>320,00</b>



## 2 jaws floating jaws puller

- External hooking
- Chrome vanadium steel jaws

CODE	A/mm	B/mm	C/mm	D/mm	Ton.	€/Pz
FG 160/GL1	80	80	10.7	7.90	1	<b>85,00</b>
FG 160/GL2	116	122	11.0	8.10	3	<b>105,00</b>
FG 160/GL3	160	161	14.2	11.1	5	<b>160,00</b>
FG 160/GL4	200	202	19.0	14.5	8	<b>185,00</b>

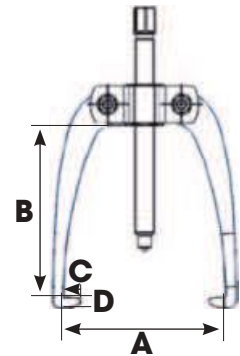

## Replacement jaw

CODE	FOR:	€/Pz
FG 160/GL1-G1	FG 160/GL1	<b>17,00</b>
FG 160/GL2-G2	FG 160/GL2	<b>17,00</b>
FG 160/GL3-G3	FG 160/GL3	<b>30,00</b>
FG 160/GL4-G4	FG 160/GL4	<b>39,00</b>

## Replacement screw

CODE	FOR:	€/Pz
FG 160/GL1-V1	FG 160/GL1	<b>22,00</b>
FG 160/GL2-V2	FG 160/GL2	<b>35,00</b>
FG 160/GL3-V3	FG 160/GL3	<b>49,00</b>
FG 160/GL4-V4	FG 160/GL4	<b>50,00</b>



## 3 jaws floating jaws puller

- External hooking
- Chrome vanadium steel jaws

CODE	A/mm	B/mm	C/mm	D/mm	Ton.	€/Pz
FG 161/GL1	80	80	10.7	7.90	1	<b>105,00</b>
FG 161/GL2	116	122	11.0	8.10	3	<b>130,00</b>
FG 161/GL3	160	161	14.2	11.1	5	<b>200,00</b>
FG 161/GL4	200	202	19.0	14.5	8	<b>240,00</b>

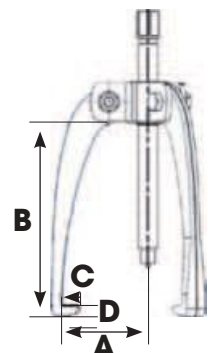

## Replacement jaw

CODE	FOR:	€/Pz
FG 160/GL1-G1	FG 161/GL1	<b>17,00</b>
FG 160/GL2-G2	FG 161/GL2	<b>17,00</b>
FG 160/GL3-G3	FG 161/GL3	<b>30,00</b>
FG 160/GL4-G4	FG 161/GL4	<b>39,00</b>

## Replacement screw

CODE	FOR:	€/Pz
FG 160/GL1-V1	FG 161/GL1	<b>22,00</b>
FG 160/GL2-V2	FG 161/GL2	<b>35,00</b>
FG 160/GL3-V3	FG 161/GL3	<b>49,00</b>
FG 160/GL4-V4	FG 161/GL4	<b>50,00</b>



**2 oscillating jaws puller**

- External hooking
- Chrome vanadium steel jaws



CODE	A/mm	B/mm	C/mm	€/Pz
FG 160/OS1	105	110	70	92,00
FG 160/OS2	185	175	80	135,00
FG 160/OS3	225	240	113	205,00
FG 160/OS4	225	290	160	225,00
FG 160/OS5	400	350	161	390,00

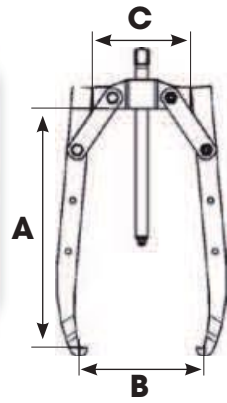

**Raplacement jaw**

CODE	FOR:	€/Pz
FG 160/OS1-G1	FG 160/OS1	17,00
FG 160/OS2-G2	FG 160/OS2	30,00
FG 160/OS3-G3	FG 160/OS3	44,00
FG 160/OS4-G4	FG 160/OS4	46,00
FG 160/OS1-G5	FG 160/OS5	92,00

**Vite di ricambio**

CODE	FOR:	€/Pz
FG 160/OS1-V1	FG 160/OS1	24,00
FG 160/OS2-V2	FG 160/OS2	38,00
FG 160/OS3-V3	FG 160/OS3	56,00
FG 160/OS4-V4	FG 160/OS4	70,00
FG 160/OS1-V5	FG 160/OS5	85,00

**3 oscillating jaws puller**

- External hooking
- Chrome vanadium steel jaws



CODE	A/mm	B/mm	C/mm	€/Pz
FG 161/OS1	105	110	80	140,00
FG 161/OS2	185	175	104	210,00
FG 161/OS3	225	240	108	285,00
FG 161/OS4	225	290	160	315,00
FG 161/OS5	400	350	161	625,00

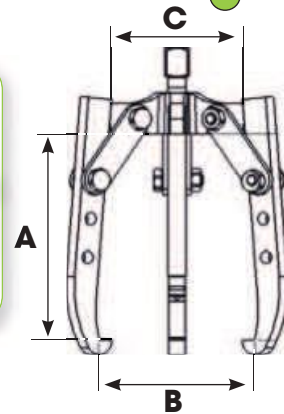

**Raplacement jaw**

CODE	FOR:	€/Pz
FG 160/OS1-G1	FG 161/OS1	17,00
FG 160/OS2-G2	FG 161/OS2	30,00
FG 160/OS3-G3	FG 161/OS3	44,00
FG 160/OS4-G4	FG 161/OS4	46,00
FG 160/OS1-G5	FG 161/OS5	92,00

**Vite di ricambio**

CODE	FOR:	€/Pz
FG 160/OS1-V1	FG 161/OS1	24,00
FG 160/OS2-V2	FG 161/OS2	38,00
FG 160/OS3-V3	FG 161/OS3	56,00
FG 160/OS4-V4	FG 161/OS4	70,00
FG 160/OS1-V5	FG 161/OS5	85,00

**Hydraulic presses**

- Manual return system
- 5 strokes
- Capacity: 9 Ton



CODE	€/Pz
FG 162/MA1	320,00

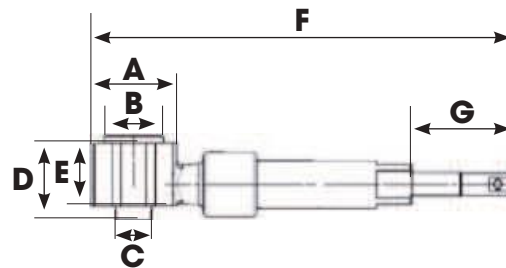

A/mm	B/mm	C/mm	D/mm	E/mm	F/mm	G/mm
48	34	20	43	35	238	58

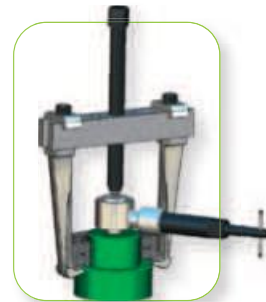

**Hydraulic presses**

- Automatic return system
- 2 strokes
- Capacity: 11 Ton



CODE	€/Pz
FG 162/MA3	510,00

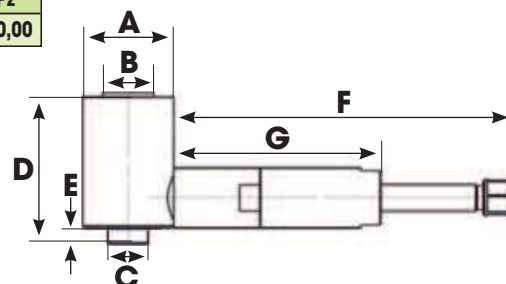

A/mm	B/mm	C/mm	D/mm	E/mm	F/mm	G/mm
70	25	28	82	12	170	103



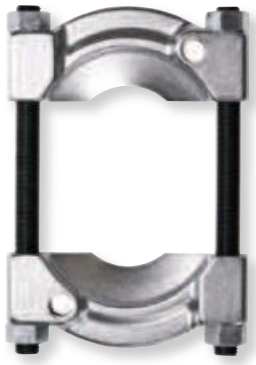

### Separator

CODE	Ømm	L/mm	€/Pz
FG 166/1	5 - 50	60	70,00
FG 166/2	15 - 110	110	130,00
FG 166/3	15 - 150	150	220,00



### Beam

CODE	Ømm	L/mm	€/Pz
FG 167/1	25 - 95	90	62,00
FG 167/2	40 - 120	180	102,00
FG 167/3	75 - 190	245	220,00
FG 167/4	80 - 280	200	375,00

COUPLING BEAMS - SEPARATORS	
FG 167/1	-
FG 167/2	FG 166/1
FG 167/3	FG 166/2
FG 167/4	FG 166/3



### Internal extractors

CODE	A/mm	M	C/mm	€/Pz
FG 182/ES1	8.6-9.6	M10	1.5	47,00
FG 182/ES2	13-18	M10	1.5	58,00
FG 182/ES3	21-23	M10	1.5	60,00
FG 182/ES4	25-29	M10	1.5	62,00
FG 182/ES5	27.2-27.6	M10	2.5	95,00
FG 182/ES6	36.5-37	M10	3.5	98,00
FG 182/ES7	43-51	M16	3.5	118,00

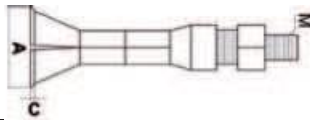

### Pullers for internal extractor

CODE	Ø/mm	M	L/mm	€/Pz
FG 182/EG1	35 - 75	M10	140	77,00
FG 182/EG2	60 - 140	M16	160	118,00

### Set of internal extractors and accessories

CODE	CONTENT	€/Pz
FG 182/S10	FG 182/ES1 FG 182/ES7 FG 182/EG1 FG 182/EG2 FG 182/MI	850,00



### Set of internal extractors and accessories

**NEW**

CODE	CONTENT	€/Pz
FG 182/S5B	FG 182/EG1 FG 182/ES1 FG 182/ES2 FG 182/ES3 FG 182/ES4 FG 182/ES5	460,00



### Dummy ball bearing extractors set - Ømm: 5, 6, 8, 9, 11, 12.5

CODE	€/Pz
FG 182/S14	230,00



### Sliding hammer

CODE	L/mm	M	€/Pz
FG 182/MI	390	M10	78,00



### Extractors for broken screws

CODE	M	■ - ◆	L/mm	€/Pz
FG 168/R6	6	1/4" - 21mm	60	13,00
FG 168/R7	7	1/4" - 21mm	60	13,00
FG 168/R8	8	1/4" - 21mm	60	14,00
FG 168/R9	9	1/4" - 21mm	69	15,00
FG 168/R10	10	1/4" - 21mm	69	15,00
FG 168/R10.5	10.5	1/4" - 21mm	69	15,00
FG 168/R12	12	1/4" - 21mm	69	15,00
FG 168/R14	14	- 24mm	73	21,00
FG 168/R16	16	- 24mm	73	22,00

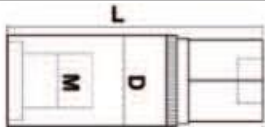

### Set of 9pcs roller stud extractors

CODE	CONTENT	€/Pz
FG 168/S9	FG 168/R6 - R16	175,00

### Tapered extractors for broken screws

CODE	Ø/mm	A/mm	€/Pz
FG 168/F1	3-6	2.5	2,90
FG 168/F2	6-8	3.0	2,90
FG 168/F3	8-11	4.5	4,00
FG 168/F4	11-14	6.0	4,60
FG 168/F5	14-18	8.0	5,10
FG 168/F6	18-24	11.0	7,00
FG 168/F7	24-33	14.0	13,00
FG 168/F8	33-50	21.0	18,00

A ↓



### Set of tapered extractors

CODE	CONTENT	€/Pz
FG 168/FS5	FG 168/F1 - F5	18,50
FG 168/FS8	FG 168/F1 - F8	60,00

### Tapered extractors for broken screws

- Percussion mechanism

CODE	Ø/mm	€/Pz
FG 168EP/S5	3 - 9	32,00



### Threaded extractor set

- equipped with internal and external guides and drill bits  
- for screws/bolts with diameter 6-16mm

CODE	€/Pz
FG 168/S25	140,00



### Nut splitter

CODE	Ø Max	L/mm	€/Pz
FG 168/SD1	12mm	62	18,00
FG 168/SD2	17mm	82	24,00
FG 168/SD3	22mm	106	33,00
FG 168/SD4	35mm	125	45,00



### Set of 4pcs nut splitters

CODE	CONTENT	€/Pz
FG 168SD/S4	FG 164/SD1 - SD4	150,00

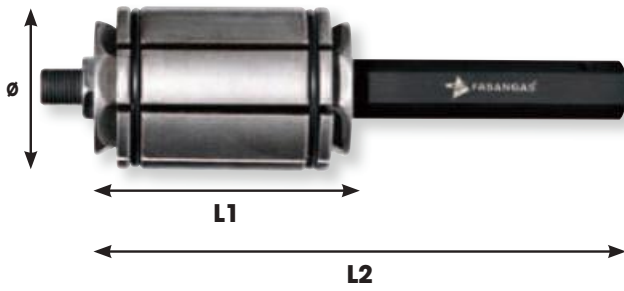

### Internal expander

CODE	Ø/mm	L1/mm	L2/mm	€/Pz
FG 182/TS1	29-44	51	132	<b>31,00</b>
FG 182/TS2	38-64	64	164	<b>43,00</b>
FG 182/TS3	54-89	77	215	<b>75,00</b>







5 M x 25MM

FASANO  
TOOLS

FG 4MMTS

# 09

## MEASURING TOOLS



**FASANO**



## Choice the right tape for your need:

Blade width	Horizontal stand-out	Vertical stand-out	Back side Vertical stand-out
16mm	1.5m	2.1m	
19mm	1.8m	2.6m	3.5m
25mm	2.3m	3.6m	5.8m
27mm	2.9m	4.6m	6.8m

**NILYON COATED BLADE** combined with high performance nylon and special coating process, the nylon coating covers the entire blade surface ensuring its abrasion resistance, anti-corrosion and prolonging its durability

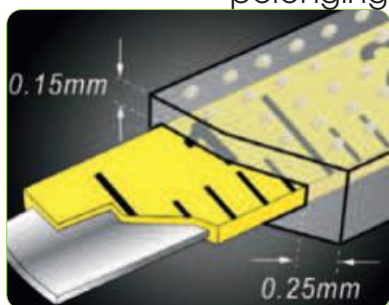

## EASY release brake



CODE	L/mt.	TAPE	€/Pz
FG 44/MT3	3	16mm	11,00
FG 44/MT5	5	25mm	18,00
FG 44/MT8	8	25mm	24,00
FG 44/MT10	10	25mm	29,00

## Measuring tape with ABS case and nylon-coated steel blade

### CLASSE II

CODE	L/mt.	BANDA	€/Pz
FG 43/MT3	3	16mm	7,00
FG 43/MT5	5	19mm	9,00



## Measuring rule with ABS case and fiber glass tape

### CLASSE III

CODE	L/mt.	€/Pz
FG 45/MT10	10	11,00
FG 45/MT20	20	12,00



## Folding ruler made in fiberglass

### Precision class II

- EGRAVED SCALE
- DOUBLE SPRING JOINT
- STOP AT 90°
- NO CONDUCTIVE, WASHABLE

CODE	L/mt.	€/Pz
FG 46/FR2	2	9,00

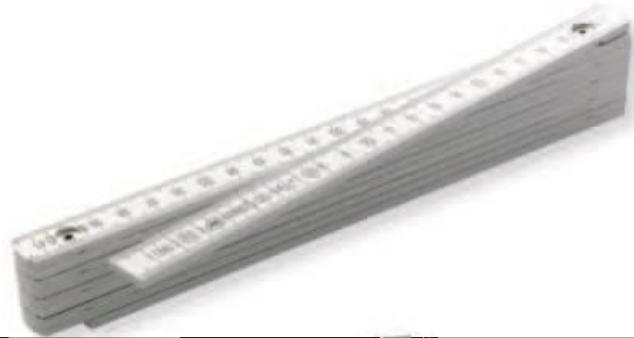

## Simple precision square unhardened

### DIN 875/0

CODE	mm	€/Pz
FG 81/S1	100x70	17,50
FG 81/S2	150x100	20,00
FG 81/S3	200x130	27,50
FG 81/S4	250x165	32,00
FG 81/S5	300x200	38,00



## Flanged precision square unhardened

### DIN 875/0

CODE	mm	€/Pz
FG 81/C1	100x70	20,00
FG 81/C2	150x100	24,00
FG 81/C3	200x130	31,00
FG 81/C4	250x165	36,00
FG 81/C5	300x200	44,00



## Spirit magnetic level with 3 infrangible vials

CODE	mm	€/Pz
FG 94/300	300	28,00
FG 94/600	600	38,00
FG 94/800	800	54,00
FG 94/1000	1000	70,00



**Engineer's scriber**

CODE	€/Pz
FG 81/PT1	23,00

**Black steel, hardened tips (straight -bent)**

CODE	€/Pz
FG 81/PT2	8,50

**Professional pencil**

CODE	€/Pz
FG 81/MS	0,70

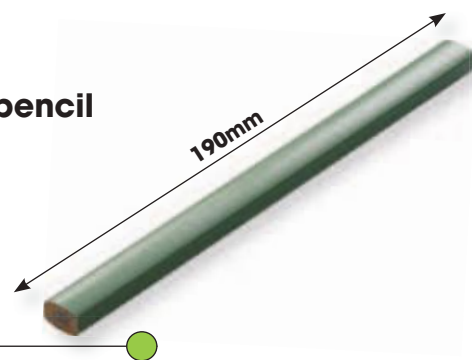
**Screw pitch gauge**

- Metric 0.4 ÷ 6.0

CODE	€/Pz
FG 95/CF	16,00

**Professional caliper reading to 0.02 Mm**

- Chrome plated scale
- Locking screw

CODE	€/Pz
FG 95/CA	50,00

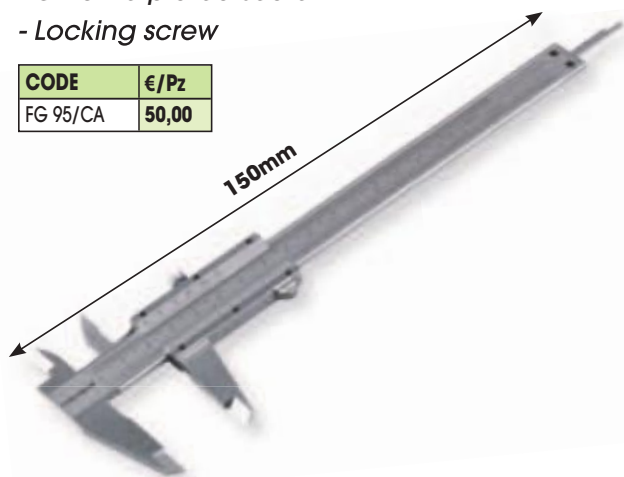
**Professional caliper reading to 0.02 Mm**

- Chrome plated scale
- Locking screw
- Stainless steel body

CODE	€/Pz
FG 95/CA2	125,00

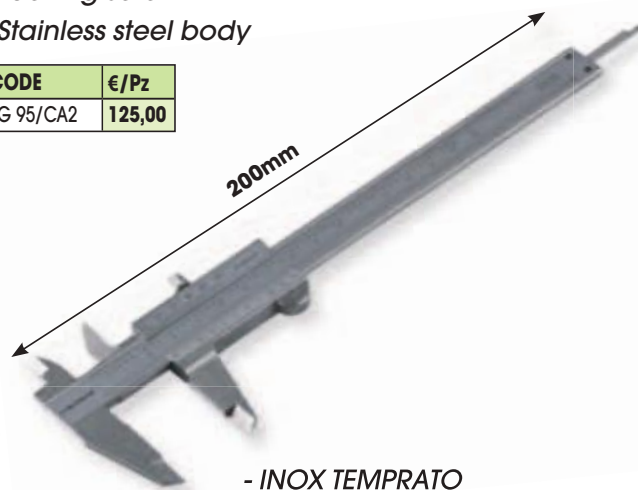
**Professional depth caliper, reading to 0.02 Mm**

- Chrome plated scale
- Locking screw
- Stainless steel body

CODE	mm	€/Pz
FG 95/CP1	200	95,00

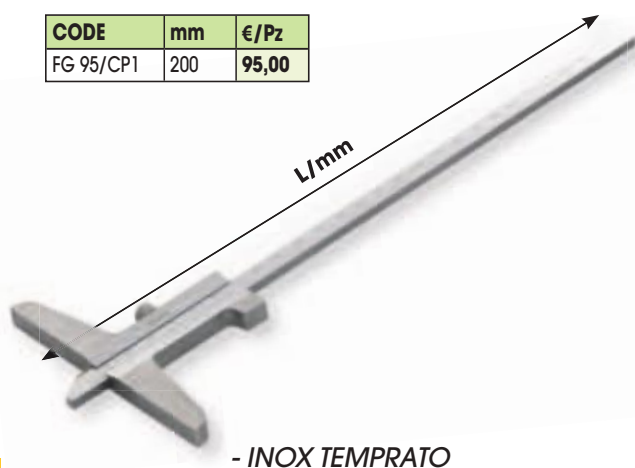
**Professional digital caliper reading to 0.01 Mm**

CODE	€/Pz
FG 95/DG	90,00

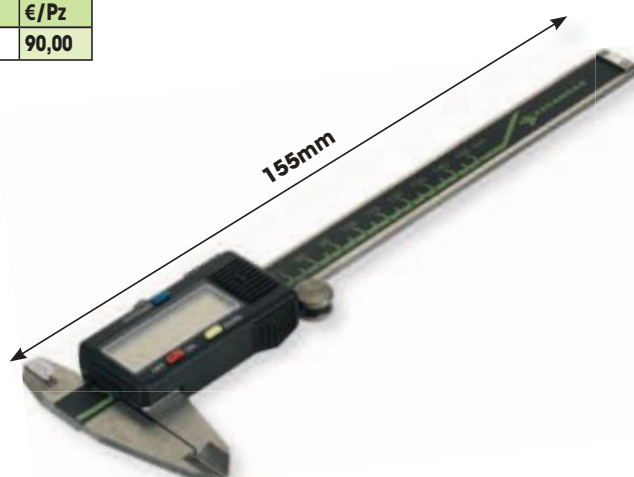

## Protractor

- Anti-reflective reading scale
- Screw locking
- Resolution 1 °

CODE	mm	SCALA	€/Pz
FG 95/GO1	120	0-180°	<b>70,00</b>
FG 95/GO2	150	0-180°	<b>86,00</b>
FG 95/GO3	200	0-180°	<b>102,00</b>

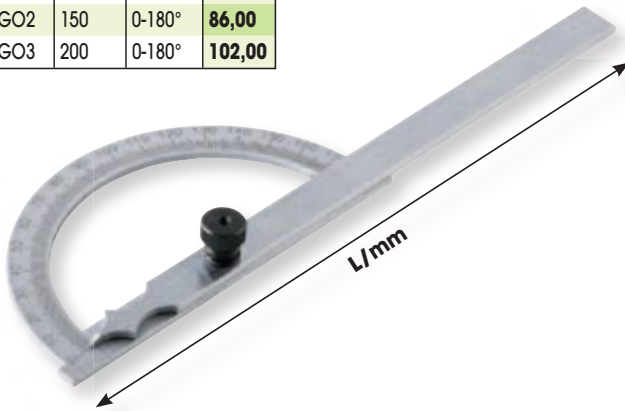

## Micrometers

- Carbide steel tips
- Ø 6.5mm
- Plated frame

CODE	Ø/mm	Resolution	€/Pz
FG 95/M1	0-25	0,01	<b>56,00</b>
FG 95/M2	25-50	0,01	<b>60,00</b>
FG 95/M3	50-75	0,01	<b>70,00</b>
FG 95/M4	75-100	0,01	<b>86,00</b>



## Dial gauge

- Rack rod in hardened stainless steel
- Rotating dial with adjustable tolerance indexes
- Upper screw for manual reset

CODE	€/Pz
FG 95/CO	<b>110,00</b>

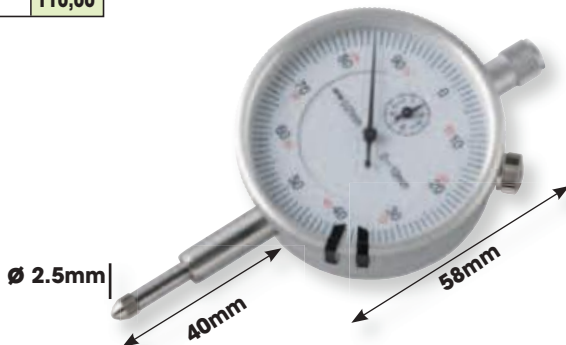

## Magnetic base for dial gauge

- Magnetic adhesion force: 600N
- Comparator connection Ø 6-8mm
- Revolving rod length: 150mm

CODE	€/Pz
FG 95/BA	<b>75,00</b>



## Thermomètre digital à infrarouge avec système de pointage laser

CODE	€/Pz
FG 97/T1	<b>250,00</b>
FG 97/T2	<b>620,00</b>



TECHNICAL FEATURES	FG 97/T1	FG 97/T2
Gamme de mesure	-32°C ~ 760°C / -25°F ~ 1.400°F	-32°C ~ 1.650°C / -25°F ~ 3.002°F
Scale	°C / °F	°C / °F
Précision (TA = 25°C / 77°F)	± 3°C (± 5°F) da -32°C ~ -20°C (-25°F ~ -4°F) ± 2°C (± 3°F) da -20°C ~ -100°C (-4°F ~ -212°F) ± 2% over 100°C (212°F)	
Laser	< 1mW	
Reply	0.5 sec	
ÉMISSIVITÉ	0.1 ~ 1.0 adjustable	
Rapport de distance	12:1	50:1
Température	0°C ~ 75°C / 32°F ~ 122°F	
Humidité	0% ~ 90% RH	
Display CD rétroéclairé	Si	
Auto power off	Oui, après 6 secondes	
Fonction de mémoire	Oui jusqu'à 10 enregistrements différents	
Batterie	1pc 9V Batterie (inclus)	
Coffret	nylon	ABS
Dimension et poids	180x130x40 mm / 195g.	200x166x51mm / 280g.





10

**PNEUMATIC TOOLS**

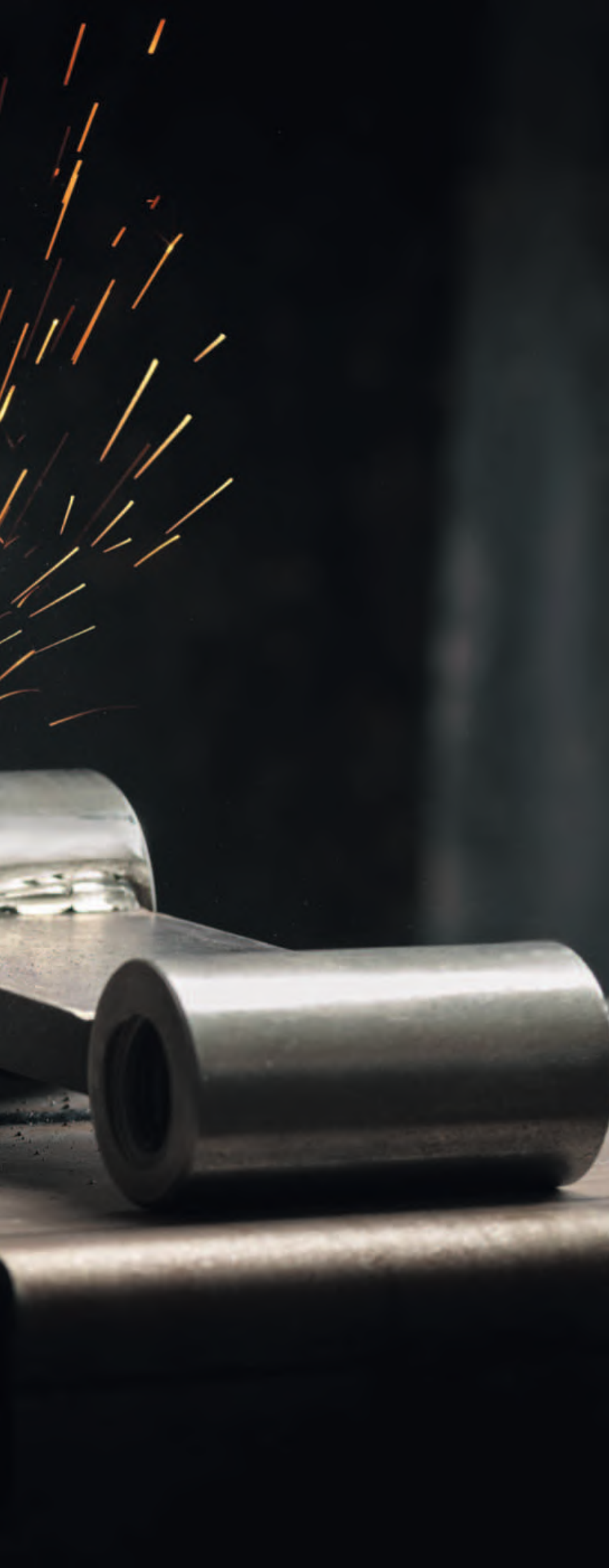





**FASANO**  
TOOLS



**Max  
Torque**



**Jumbo  
Hammer**

### Impact wrench-1/2"

 1.200	 746 Nm	 610 Nm
 136 L/min	 9.500 RPM	 6.2 Bar

CODE	€/Pz
FGA 307	250,00

CE



**Max  
Torque**



**Twin  
Hammer**

### Impact wrench-1/2"

 1.900	 1.085 Nm	 746 Nm
 151 L/min	 7.300 RPM	 6.2 Bar

CODE	€/Pz
FGA 309	300,00

CE





**Max  
Torque**



**Twin  
Hammer**

**Impact wrench-1/2"**

**2.000**

**1.130  
Nm**

**950**

**136  
L/min**

**7.500  
RPM**

**6.2  
Bar**

CODE	€/Pz
FGA 312	380,00

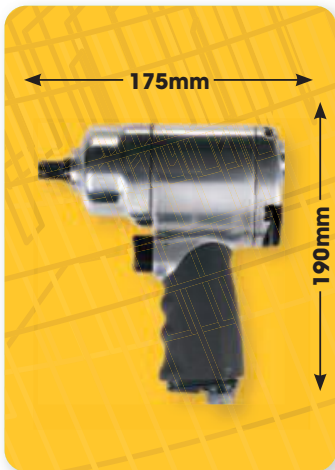

**Twin  
Hammer**

**Impact wrench-1/2"**

**2.100**

**880  
Nm**

**745**

**127  
L/min**

**7.800  
RPM**

**6.2  
Bar**

CODE	€/Pz
FGA 302	245,00





**Set of 1/2"dr. impact wrench FGA 302  
+ 3pcs 1/2"dr. impact sockets**

CODE	CONTENUTO	€/Pz
FGA 302/S4	FGA 302 FG 628/R17, 19, 21	285,00



**Set of 1/2"dr. impact wrench FGA 302  
+ 9pcs 1/2"dr. impact sockets**

CODE	CONTENUTO	€/Pz
FGA 302/S10	FGA 302 FG 628/C10,11,13,14,17,19,22,24,27	345,00



**Set of 1/2"dr. impact wrench FGA 309  
+ 3pcs 1/2"dr. impact sockets**

CODE	CONTENUTO	€/Pz
FGA 309/S4	FGA 309 FG 628/R17, 19, 21	360,00



**Set of 1/2"dr. impact wrench FGA 309  
+ 9pcs 1/2"dr. impact sockets**

CODE	CONTENUTO	€/Pz
FGA 309/S10	FGA 309 FG 628/C10,11,13,14,17,19,22,24,27	395,00



**Twin hammer**

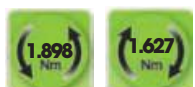

**Working  
torque**

**3/4"dr. air impact wrench**

CODE	€/Pz
FGA 316	760,00

**3/4"dr. air impact wrench  
- 6" anvil**

CODE	€/Pz
FGA 316/L	830,00





**1"dr. air impact wrench  
- 6" anvil**

CODE	€/Pz
FGA 319/L	1.250,00

**1"dr. air impact wrench**

CODE	€/Pz
FGA 319	1.150,00

2.700 Nm  
2.500 Nm

271 L/min  
4.800 RPM

10.200  
6:2 Bar

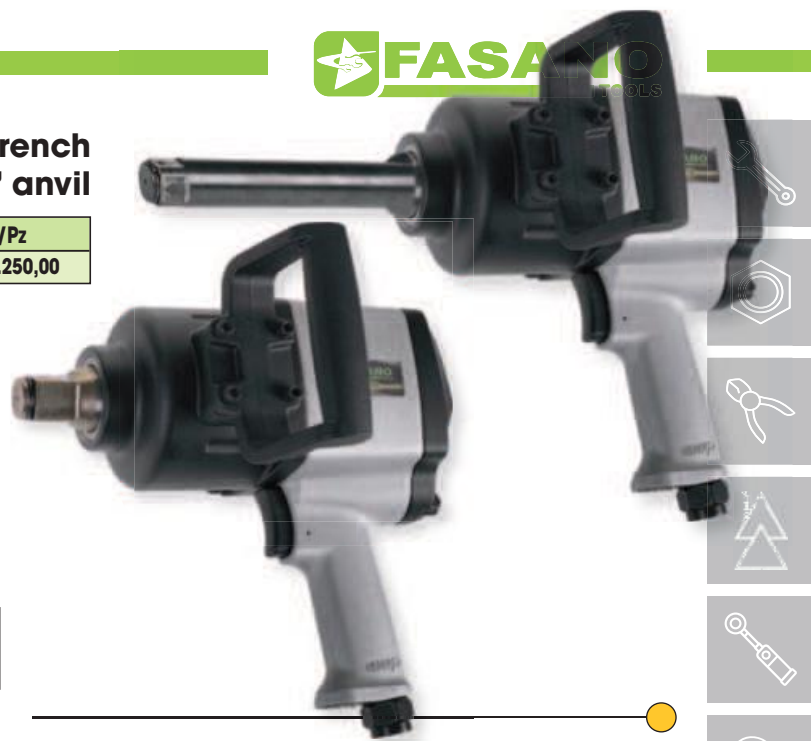

**1"dr. air impact wrench  
- 6" anvil**

CODE	€/Pz
FGA 321/C	1.220,00

**Pin-Less**

2.700 Nm  
2.500 Nm

271 L/min  
4.800 RPM

12.500  
6:2 Bar



**Twin Hammer**

**1"dr. air impact wrench**



CODE	€/Pz
FGA 321	1.050,00

2.576 Nm  
5.500 RPM

340 L/min  
1/2" 13mm

6.800  
6:2 Bar

**1"dr. air impact wrench  
- 6" anvil**



CODE	€/Pz
FGA 321/B	1.100,00

2.983 Nm





CE

1/4"dr. air ratchet wrench

40 Nm	280 RPM	730
68 L/min	1/4" 6mm	6.2 Bar

CODE	€/Pz
FGA 290	185,00



CE

1/4"dr. air ratchet wrench

27 Nm	240 RPM	450
85 L/min	1/4" 6mm	6.2 Bar

CODE	€/Pz
FGA 291/C	135,00



CE

1/4"dr. air ratchet wrench

27 Nm	240 RPM	450
85 L/min	1/4" 6mm	6.2 Bar

CODE	€/Pz
FGA 291/B	122,00



CE

3/8"dr. air ratchet wrench

50 Nm	175 RPM	1.200
85 L/min	1/4" 6mm	6.2 Bar

CODE	€/Pz
FGA 291	170,00



Coppia torcente

340mm

1/2"dr. air ratchet wrench

300 RPM	1.300	
105 L/min	3/8" 10mm	6.2 Bar

CODE	€/Pz
FGA 292/B	215,00

CE

166mm

CE

3/8"dr. air impact wrench

1.280	475 Nm	441 Nm
130 L/min	9.000 RPM	6.2 Bar

CODE	€/Pz
FGA 304	245,00



Twin hammer

183mm



**Max  
Torque**



**Jumbo  
hammer**

**Angle air impact  
wrench - 1/2"**

<b>1.150</b>	<b>420 Nm</b>	<b>244 Nm</b>
<b>113 L/min</b>	<b>9.000 RPM</b>	<b>6.2 Bar</b>

CODE	€/Pz
FGA 307/AN	345,00



*Ultra  
compact*

*Central  
exhaust*

*Feather  
throttle*

*Rotating  
F/R ring*

*2 speed  
setting system*

**Tyre  
inflatng gun**

CODE	€/Pz
FGA 390	145,00

- CEE approved

- Aluminum nickel-plated body
- Anti-oil rubber casing
- Gauge Ø80 (0-10bar / 0-140 PSI)
- Protected against pressure fluctuation
- 2 positions inflate/deflate lever
- Tube lenght: 500mm



**Air tire buffer**

CODE	€/Pz
FGA 322	145,00

<b>2.600 RPM</b>	<b>800</b>
<b>85 L/min</b>	<b>6.2 Bar</b>

**Replacement buffer  
FGA 322/R2: 30,00€**



**Air saw**

<b>9.500 min</b>	<b>3m/s<sup>2</sup></b>	<b>400</b>
<b>99 L/min</b>	<b>6.2 Bar</b>	<b>1/4" 6mm</b>

Set of 10 blades:

CODE	€/Pz
FGA 330/24T	47,00
FGA 330/32T	47,00

CODE	€/Pz
FGA 330	295,00



# 10 PNEUMATIC TOOLS



180mm

99mm

**Angle air drill  
keyless chuck 1-10mm**

<b>(0.45) Hp</b>	<b>1.800 RPM</b>	<b>900</b>
<b>60 L/min</b>	<b>1/4" 6mm</b>	<b>6.2 Bar</b>

CODE	€/Pz
FGA 332/AN	180,00



160mm



143mm

**Reversible air drill  
keyless chuck 1-10mm**

<b>(0.45) Hp</b>	<b>1.800 RPM</b>	<b>900</b>
<b>113 L/min</b>	<b>1/4" 6mm</b>	<b>6.2 Bar</b>

CODE	€/Pz
FGA 332	145,00

205mm



**Reversible air drill  
w/steel chuck 1-13mm**

<b>(0.45) Hp</b>	<b>700 RPM</b>	<b>1.200</b>
<b>113 L/min</b>	<b>1/4" 6mm</b>	<b>6.2 Bar</b>

CODE	€/Pz
FGA 333/AC	210,00

143mm

205mm



143mm

**Reversible air drill  
w/keyless chuck 1-13mm**

<b>(0.45) Hp</b>	<b>700 RPM</b>	<b>1.300</b>
<b>113 L/min</b>	<b>1/4" 6mm</b>	<b>6.2 Bar</b>

CODE	€/Pz
FGA 333	185,00



140mm

**Angle grinder  
- ø disc: 50mm**

CODE	€/Pz
FGA 339/B	190,00

**DISK:**

<b>15.000 RPM</b>	<b>500</b>
<b>74 L/min</b>	<b>1/4" 6mm</b>
<b>6.2 Bar</b>	

CODE	€/Pz
FGA 339/B-G60	9,00
FGA 339/B-G80	10,00
FGA 339/B-G120	12,00

225mm

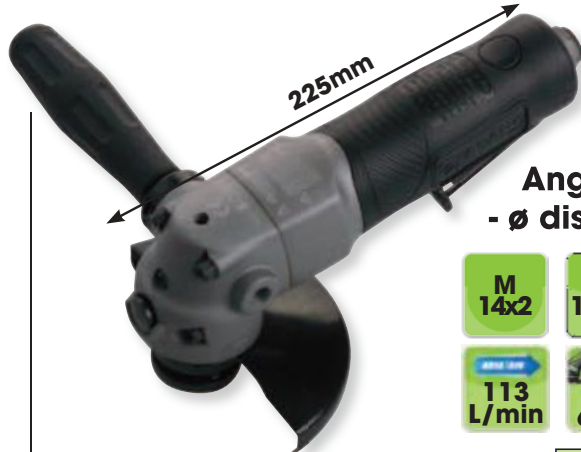

**Angle grinder  
- ø disc: 115mm**

<b>M 14x2</b>	<b>11.000 RPM</b>	<b>2.000</b>
<b>113 L/min</b>	<b>1/4" 6mm</b>	<b>6.2 Bar</b>

CODE	€/Pz
FGA 339	355,00

**Air riveter  
- 4 interchangeable heads**

<b>FORZA 12.000 N</b>	<b>CORSA 14mm</b>	<b>1.500</b>
<b>99 L/min</b>	<b>1/4" 6mm</b>	<b>6.2 Bar</b>

CODE	€/Pz
FGA 335	210,00



Ø/mm	2.4	3.2	4.0	4.8
Aluminum	X	X	X	X
Steel	X	X	X	X
INOX	X	X	X	

**Air riveter  
- 4 interchangeable heads**

<b>FORZA 13.930 N</b>	<b>CORSA 18mm</b>	<b>2.000</b>
<b>148 L/min</b>	<b>1/4" 6mm</b>	<b>6.2 Bar</b>

CODE	€/Pz
FGA 336	585,00



Ø/mm	3.0/3.2	4.0	4.8	6.4
Aluminum	X	X	X	X
Steel	X	X	X	X
INOX	X	X	X	



**NEW KEVLAR BLADES**

**Die grinder**

<b>(0.50)</b> Hp	<b>22.000</b> RPM	<b>600</b>
<b>99</b> L/min	<b>1/4"</b> 6mm	<b>6:2</b> Bar

CODE	€/Pz
FGA 338	128,00



**Die grinder**

<b>(0.35)</b> Hp	<b>25.000</b> RPM	<b>400</b>
<b>74</b> L/min	<b>1/4"</b> 6mm	<b>6:2</b> Bar

CODE	€/Pz
FGA 334	145,00



**Die grinder  
MIDDLE SPEED**

<b>(0.45)</b> Hp	<b>7.600</b> RPM	<b>600</b>
<b>74</b> L/min	<b>1/4"</b> 6mm	<b>6:2</b> Bar

CODE	€/Pz
FGA 338/B	160,00



**Angle die grinder  
- 115°**

<b>(0.35)</b> Hp	<b>22.000</b> RPM	<b>600</b>
<b>74</b> L/min	<b>1/4"</b> 6mm	<b>6:2</b> Bar

CODE	€/Pz
FGA 334/AN115	185,00



**Angle die grinder**

<b>(0.45)</b> Hp	<b>18.000</b> RPM	<b>700</b>
<b>60</b> L/min	<b>1/4"</b> 6mm	<b>6:2</b> Bar

CODE	€/Pz
FGA 338/AN	170,00



**Angle die grinder**

<b>(0.35)</b> Hp	<b>22.000</b> RPM	<b>500</b>
<b>60</b> L/min	<b>1/4"</b> 6mm	<b>6:2</b> Bar

CODE	€/Pz
FGA 334/AN	185,00



**Long extension  
die grinder**

<b>(0.45)</b> Hp	<b>22.000</b> RPM	<b>800</b>
<b>60</b> L/min	<b>1/4"</b> 6mm	<b>6:2</b> Bar

CODE	€/Pz
FGA 338/L	165,00



**Long extension  
die grinder**

<b>(0.35)</b> Hp	<b>25.000</b> RPM	<b>700</b>
<b>74</b> L/min	<b>1/4"</b> 6mm	<b>6:2</b> Bar

CODE	€/Pz
FGA 334/L	185,00





**Micro die grinder**

- Chuck capacity: 3mm



CODE	€/Pz
FGA 346/A	145,00

CE

**Micro die grinder**

- Chuck capacity: 3mm

NEW



CODE	€/Pz
FGA 346/B	220,00

CE

**Roto-orbital sander**-  $\varnothing$  orbital: 5mm

- pad with 15 holes

CODE	€/Pz
FGA 340	295,00

CE



(thread: 5/16"-24UNF)

**Roto-orbital sander**-  $\varnothing$  orbital: 2.5mm

- pad with 15 holes

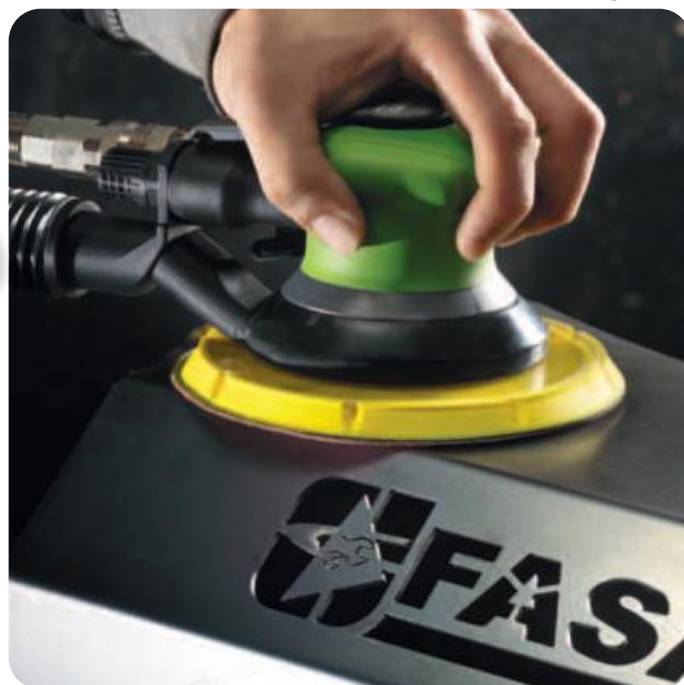

CODE	€/Pz
FGA 340/B	295,00

**Air eraser**

CODE	€/Pz
FGA 337	128,00



Rubber disc  
(thread: 5/16"-24UNF):  
FGA 337/R1: 15,00€

CE

**Roto-orbital sander**-  $\varnothing$  orbital: 2.5mm

- pad with 3 holes

CE



CODE	€/Pz
FGA 342/B	285,00



## Levigatrice multi-funzione



CODE	€/Pz
FGA 341	650,00



CODE	ø/mm	€/Pz
FGA 341/R1	110	33,00



CODE	ø/mm	€/Pz
FGA 341/R2	65	22,00



CODE	ø/mm	€/Pz
FGA 341/R3	110	22,00



CODE	GREIN	ø/mm	€/Pz
FGA 341/R4	END	110 / 0.5	22,00
FGA 341/R5	AVERAGE	110 / 0.5	22,00
FGA 341/R6	BIG	110 / 0.7	22,00



## Random orbital sander- ø orbital: 2mm



CODE	€/Pz
FGA 342	220,00

(thread: 1/4"-20UNF)

### Set 50 discs for FGA 342

CODE	GREIN	ø/mm	€/Pz
FGA 342/R120	120	32	22,00
FGA 342/R180	180	32	22,00
FGA 342/R320	320	32	22,00
FGA 342/R1000	1.000	32	27,00
FGA 342/R1500	1.500	32	27,00
FGA 342/RT120	120	50	55,00
FGA 342/RT180	180	50	55,00
FGA 342/RT320	320	50	55,00

CODE	GREIN	ø/mm	€/Pz
FGA 342/RT1000	1.000	50	55,00
FGA 342/RT1500	1.500	50	55,00
FGA 342/T120	120	32	60,00
FGA 342/T180	180	32	60,00
FGA 342/T320	320	32	60,00
FGA 342/T1000	1.000	32	72,00
FGA 342/T1500	1.500	32	72,00



## Belt sander

- 10x330mm



CODE	€/Pz
FGA 343/N10	220,00



## Belt sander

- 20x520mm



CODE	€/Pz
FGA 343/N20	285,00



- Drive dimension: 11mm
- Piston dimension: 19mm
- Punches for min: 2.000
- Air consumption: 78.4 L/min - 2,78CFM
- Air inlet: 6mm - 1/4"
- Weight: 1.94Kg



CE

**Kit of pneumatic hammer + 5 chisels**

CODE	€/Pz
FGA 345	320,00



**Washing gun**

- Aluminum nickel-plated body
- Capacity: 1Litro
- Stell suction pipe
- Air flow regulator
- Product flow regulator
- Pattern regulation nozzle
- 1/4" BSP thread

CE

CODE	€/Pz
FGA 380	65,00



**Spring for FGA 345**

CODE	€/Pz
FGA 345/M	10,50



**Needle scraper for FGA 345**

CODE	€/Pz
FGA 345/SC	110,00



**Chisels for FGA 345**

CODE	L/mm	€/Pz
FGA 345/S1	175	12,00
FGA 345/S2	175	12,00
FGA 345/S3	175	20,00
FGA 345/S4	175	13,50
FGA 345/S5	175	9,50



**Extendible polyurethane net reinforced air hose with coupling and adaptor**

CODE	Lunghezza	Ø/mm	Ø GAS	€/Pz
FGA 383	9mt.	8x12	1/4"	75,00
FGA 383/2	12mt.	8x12	1/4"	80,00
FGA 383/3	9mt.	11x16	3/8"	100,00

CODE	Ø/mm	Ø GAS	€/Pz
FGA 384/R1	8x12	1/4"	10,00
FGA 384/R2	11x16	1/4"	11,00



**Flexible PVC air hose with coupling and adaptor**

CODE	Lunghezza	Ø/mm	Ø GAS	€/Pz
FGA 382/B10	10mt.	8x12	1/4"	65,00
FGA 382/B15	15mt.	8x12	1/4"	80,00
FGA 382/B20	20mt.	8x12	1/4"	100,00
FGA 384/B15	15mt.	10x15	3/8"	100,00



### Air blow gun

- Progressive air jet
- Copper inside thread

CODE	€/Pz
FGA 416	19,00



### Air filter regulator lubricator

- Max air flow: 4.000 l/min
- Working pressure: 1.5-9.0BAR/21-128PSI
- Working temperature: 5-60°
- Oil bowl capacity: 75cc
- Air bowl capacity: 40cc
- Weight: 980gr.

CODE	ATTACCO	€/Pz
FGA 385	1/4"	135,00

CODE	ATTACCO	€/Pz
FGA 386	3/8"	135,00

CODE	ATTACCO	€/Pz
FGA 387	1/2"	135,00



### Air blow gun

- Progressive air jet
- Aluminum nickel-plated body
- Rubber grip handle

CODE	€/Pz
FGA 419	20,00



## JAPAN STYLE

CODE	BSPP	€/Pz
FGA 381/1	1/4"	10,50
FGA 381/2	3/8"	10,50
FGA 381/3	1/2"	11,00



CODE	BSPT	€/Pz
FGA 380/1	1/2"	4,20
FGA 380/2	1/4"	3,30
FGA 380/3	3/8"	3,30



CODE	BSPP	€/Pz
FGA 381/4	1/4"	11,50
FGA 381/5	3/8"	11,50



CODE	BSPP	€/Pz
FGA 380/4	1/2"	4,20
FGA 380/5	1/4"	3,30
FGA 380/6	3/8"	3,30



CODE	€/Pz
FGA 381/6	12,50
FGA 381/7	12,50

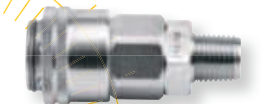

CODE	BSPT	€/Pz
FGA 381/1N	1/4"	10,00
FGA 381/2N	3/8"	10,00
FGA 381/3N	1/2"	10,50

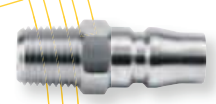

CODE	BSPT	€/Pz
FGA 380/1N	1/2"	4,00
FGA 380/2N	1/4"	3,10
FGA 380/3N	3/8"	3,10

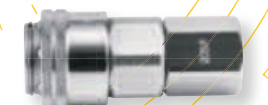

CODE	BSPT	€/Pz
FGA 381/4N	1/4"	10,80
FGA 381/5N	3/8"	10,80

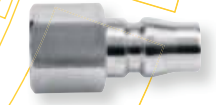

CODE	BSPT	€/Pz
FGA 380/4N	1/2"	4,00
FGA 380/5N	1/4"	3,10
FGA 380/6N	3/8"	3,10



CODE	EXIT	BSP	€/Pz
FGA 377/1	6mm	1/4"	25,50
FGA 377/2	6mm	1/4"	21,00
FGA 377/3	6mm		25,50

CODE	BSP	€/Pz
FGA 376/1	1/4"	6,50
FGA 376/2	1/4"	6,50

CODE	EXIT	BSP	€/Pz
FGA 379/1	8mm	3/8"	33,00
FGA 379/2	8mm	3/8"	31,00
FGA 379/3	8mm		33,00

CODE	BSP	€/Pz
FGA 378/1	1/4"	10,00
FGA 378/2	1/4"	10,00



**Lubricating oil for pneumatic tools**

- 500CC
- Density 20°: 875 Kg/m<sup>3</sup>
- Viscosity 40°: 32 cST
- Flammability COC: 210°

CODE	€/Pz
FGA 388/OL	16,00



**Universal swivel coupling**

CODE	BSPT THREAD	BSP THREAD	€/Pz
FGA 380/SN	1/4"	1/4"	20,00



NEW



**Automatic hose reel for compressed air -15mt.**

- ø internal hose: 8mm

CODE	€/Pz
FGA 383/AR15	270,00

**Automatic hose reel for compressed air -15mt.**

- ø internal hose: 10mm

CODE	€/Pz
FGA 385/AR15	360,00

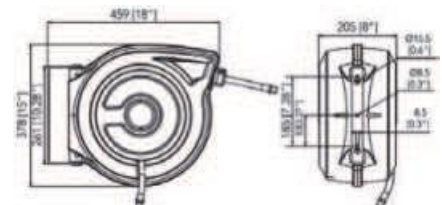
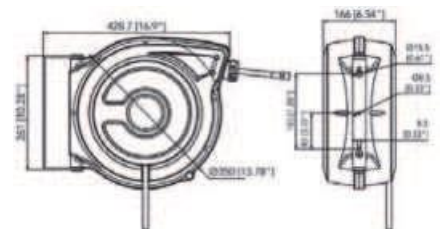

**Braided polyurethane hose 360° adjustable wall bracket**



**Automatic guide system**



**Stop at any point**

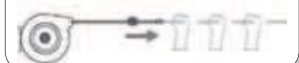

**Slow retraction system**



**Maintenance kit for FGA 302**

CODE	€/Pz
FGA 302/KIT	30,00



**Maintenance kit for FGA 304**

CODE	€/Pz
FGA 304/KIT	30,00



**Maintenance kit for FGA 307**

CODE	€/Pz
FGA 307/KIT	30,00



**Maintenance kit for FGA 307/AN**

CODE	€/Pz
FGA 307AN/KIT	30,00



**Maintenance kit for FGA 309**

CODE	€/Pz
FGA 309/KIT	45,00



**Maintenance kit for FGA 312**

CODE	€/Pz
FGA 312/KIT	45,00



**Maintenance kit FGA 316-FGA 316/L**

CODE	€/Pz
FGA 316/KIT	100,00



**Maintenance kit for FGA 319 e FGA 319/L**

CODE	€/Pz
FGA 319/KIT	100,00



**Maintenance kit for FGA 321 e FGA 321/B**

CODE	€/Pz
FGA 321B/KIT	220,00



**Maintenance kit for FGA 290**

CODE	€/Pz
FGA 290/KIT	20,00



**Maintenance kit for FGA 291**

CODE	€/Pz
FGA 291/KIT	30,00



### Maintenance kit for FGA 292/B

CODE	€/Pz
FGA 292B/KIT	30,00

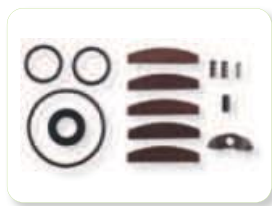

### Maintenance kit for FGA 322

CODE	€/Pz
FGA 322/KIT	28,00



### Maintenance kit for FGA 330

CODE	€/Pz
FGA 330/KIT	30,00



### Maintenance kit FGA 332/AN

CODE	€/Pz
FGA 332AN/KIT	28,00



### Maintenance kit for FGA 332

CODE	€/Pz
FGA 332/KIT	28,00



### Maintenance FGA 333-FGA 333/AC

CODE	€/Pz
FGA 333/KIT	28,00

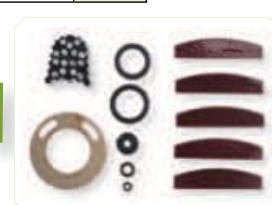

### Maintenance kit for FGA 334

CODE	€/Pz
FGA 334/KIT	35,00



### Maintenance kit FGA 334/AN

CODE	€/Pz
FGA 334AN/KIT	35,00

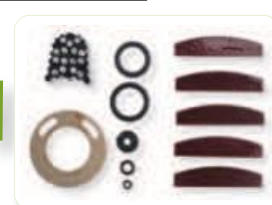

### Maintenance kit FGA 334/AN115

CODE	€/Pz
FGA 334AN115/KIT	35,00

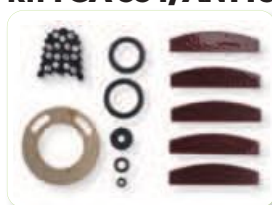

### Maintenance kit FGA 334/L

CODE	€/Pz
FGA 334L/KIT	35,00



### Maintenance kit for FGA 335

CODE	€/Pz
FGA 335/KIT	22,00



### Maintenance kit FGA 336

CODE	€/Pz
FGA 336/KIT	35,00

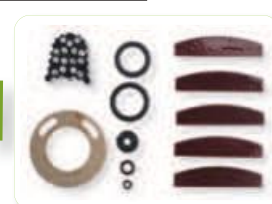

**Maintenance kit for FGA 337**

CODE	€/Pz
FGA 337/KIT	28,00



**Maintenance kit for FGA 338**

CODE	€/Pz
FGA 338/KIT	28,00



**Maintenance kit for FGA 338/B**

CODE	€/Pz
FGA 338B/KIT	28,00



**Maintenance kit FGA 338/AN**

CODE	€/Pz
FGA 338AN/KIT	28,00



**Maintenance kit for FGA 338/L**

CODE	€/Pz
FGA 338L/KIT	28,00



**Maintenance kit for FGA 339**

CODE	€/Pz
FGA 339/KIT	40,00



**Maintenance kit FGA 339/B**

CODE	€/Pz
FGA 339B/KIT	28,00



**Maintenance kit FGA 340-FGA 340/B**

CODE	€/Pz
FGA 340/KIT	30,00



**Maintenance kit FGA 341**

CODE	€/Pz
FGA 341/KIT	20,00

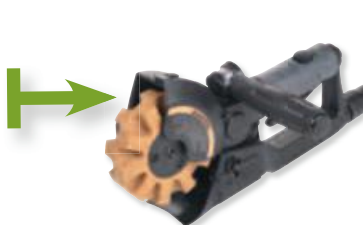

**Maintenance kit for FGA 342**

CODE	€/Pz
FGA 342/KIT	20,00



**Maintenance kit for FGA 345**

CODE	€/Pz
FGA 345/KIT	20,00

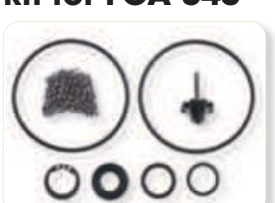

**Maintenance kit for FGA 343/N10 & FGA 343/N20**

CODE	€/Pz
FGA 343N10/KIT	20,00
FGA 343N20/KIT	20,00







0  
12.2V

Pistone 1

Pistone 2

Pistone 3

Pistone 4



11

**SPECIAL TOOLS  
FOR AUTOMOTIVE**



**Oil filter cup wrench**



CODE	Side	Ø mm	€/Pz
FG 175/B1	14	65	8,50
FG 175/B2	14	65/67	8,50
FG 175/B3	14	68	8,50
FG 175/B4	14	73	8,50
FG 175/B5	15	74	8,50
FG 175/B6	15	74/76	8,50
FG 175/B7	15	75/77	8,50
FG 175/B8	14	76	8,50
FG 175/B9	8	76	8,50
FG 175/B10	15	78	9,00

CODE	Side	Ø mm	€/Pz
FG 175/B11	15	80	9,00
FG 175/B12	15	80/82	9,50
FG 175/B13	16	86	9,50
FG 175/B14	15	90	9,50
FG 175/B15	10	92	9,50
FG 175/B16	15	93	9,50
FG 175/B17	15	95	9,50
FG 175/B18	15	100	11,50
FG 175/B19	15	106	11,50
FG 175/B20	15	108	11,50
FG 175/B21	15	135	19,00

**Oil filter cup wrench  
Purflux model**

**PURFLUX**



CODE	Side	Ø mm	€/Pz
FG 175/PF66	6	66	9,50
FG 175/PF76-12	12	76	9,50
FG 175/PF76-30	30	76	9,50
FG 175/PF86-18	18	86	10,50

CODE	Side	Ø mm	€/Pz
FG 175/PF93-36	36	96	10,50
FG 175/PF93-45	45	93	10,50
FG 175/PF96-18	18	96	11,00
FG 175/PF108-18	18	108	12,00
FG 175/PF135-18	18	135	21,00



**Set 4pcs oil filter cup wrench - Purflux model**

CODE	€/Pz
FG 175PF/S4	72,00

**CONTENT:**  
FG 175/PF66, FG 175/PF76  
FG 175/PF86, FG 175/PF96



**Set 28pcs oil filter cup wrench**

CODE	€/Pz
FG 175/S30	215,00

**CONTENT:**  
FG 175/B1 - FG 175/B20  
FG 175/PF66 - FG 175/PF108-18  
01 Adjustable oil filter wrench 60-120mm  
01 Adaptor 1/2"x3/8"

**Oil filter cartridge wrench**

27mm

CODE	Side	Ø mm	€/Pz
FG 175/C1	6	24	9,00
FG 175/C2	6	27	9,00
FG 175/C3	6	30	9,00
FG 175/C4	6	32.5	9,50
FG 175/C5	6	36	9,50
FG 175/C6	6	38	9,50



**Set of 6pcs oil fileter cartridges wrenches**

CODE	€/Pz
FG 175/S6	60,00

**Oil filter cup wrench  
FORD 1.0,2.0,2.3 EcoBoost**

CODE	Side	Ø mm	€/Pz
FG 175/FO74	14	74	44,00



**Oil filter cup wrench  
FORD 1.5, 1.6 EcoBoost**

CODE	Side	Ø mm	€/Pz
FG 175/FO74.5	15	74.5	44,00

3/8"



**Oil filter cup wrench**

CODE	Side	Ø mm	H/mm	€/Pz
FG 175/FO8	8	78	35	38,00
FG 175/FO10	10	95	43	49,00
FG 175/FO14	14	75	43	51,00



1/2"

**Oil filter cup wrench - Mercedes CDI**

CODE	Side	Ø mm	€/Pz
FG 175/FO14M	14	74	34,00



1/2"

**Oil filter cup wrench - Hyundai TUCSON**

CODE	Side	Ø mm	€/Pz
FG 175/Hi	14	81	65,00



1/2"

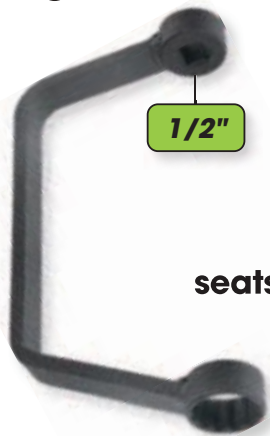

1/2"

**Special wrench for plastic seats of oil filters engines OPEL**

CODE	Ø mm	€/Pz
FG 175/A32	32	28,00

**Oil filter strap wrench**

CODE	Ø mm	€/Pz
FG 176/NA1	160	35,00
FG 176/NA2	240	40,00

*Spare tape*

CODE	FOR:	€/Pz
FG 176/NA1-R	FG 176/NA1	15,50
FG 176/NA2-R	FG 176/NA2	17,50



**Oil filter cup wrench - Mercedes**

CODE	Side	Ø mm	€/Pz
FG 175/FO84	14	84	55,00



1/2"

**Oil filter cup wrench - Toyota**

CODE	Side	Ø mm	€/Pz
FG 175/FO14T	14	79	29,00



1/2"

**Opel/Vauxhall oil filter wrench**

CODE	Side	Ø mm	€/Pz
FG 175/OP1	15	74,7	45,00

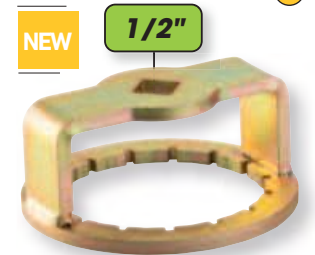

NEW

1/2"

**Adjustable oil filter wrench**

CODE	Ø mm	€/Pz
FG 176/RP	65 - 110	45,00
FG 176/RP2	110 - 150	48,00



**Adjustable oil filter wrench**

CODE	Ø mm	€/Pz
FG 176/RE	65 - 110	35,00

*Spare metal tape for FG 176/RE and FG 176/RP*

CODE	€/Pz
FG 176/RE-SP	8,50

**Oil filter wrench - double chain**

CODE	Ø mm	€/Pz
FG 177/FO1	60-115	82,50



1/2"

**Oil filter wrench - double chain**

CODE	Ø mm	€/Pz
FG 176/FO1	60-110	85,00
FG 176/FO2	60-160	90,00



*Spare chain*

CODE	FOR:	€/Pz
FG 176/FO1-C	FG 176/FO1	32,00
FG 176/FO2-C	FG 176/FO2	45,00
FG 177/FO1-C	FG 177/FO1	40,00



**Adjustable oil filter pliers**

CODE	Ø mm	■	€/Pz
FG 178/SD	95 - 165	1/2"	135,00



**Adjustable oil filter pliers**

CODE	Ø mm	■	€/Pz
FG 178/3L	60-120	1/2"	30,00



**Adjustable self-locking oil filter pliers**

CODE	Ø mm	€/Pz
FG 176/CJ	53 - 118	32,00



**Oil drain plug socket with XZN profile**

CODE	M	€/Pz
FG 175/XZN16	16	8,00



**Set for oil drain repair**

CODE	€/Pz
FG 175/S114	255,00

- M13x1.25
- M13x1.5
- M15x1.5
- M17x1.5
- M20x1.5
- M22x1.5

**Oil drain plugs**

CODE	€/Pz
FG 175/OD13x1.25	3,50
FG 175/OD13x1.5	3,50
FG 175/OD15x1.5	3,50
FG 175/OD17x1.5	3,40
FG 175/OD20x1.5	3,40
FG 175/OD22x1.5	4,20



**Washers**

CODE	€/Pz
FG 175/W13x1.5	0,50
FG 175/W15x1.5	0,50
FG 175/W17x1.5	0,60
FG 175/W20x1.5	0,80
FG 175/W22x1.5	0,90

**Taps**

CODE	€/Pz
FG 175/M13x1.25	16,00
FG 175/M13x1.5	15,00
FG 175/M15x1.5	16,00
FG 175/M17x1.5	18,50
FG 175/M20x1.5	19,50
FG 175/M22x1.5	21,50



**Oil plug wrench**

CODE	€/Pz
FG 175/A8X10	22,00

**NEW**



**Set of 18 oil drain plugs - magnetic**

CODE	€/Pz
FG 175/S15	130,00



CONTENT	
⬡	8,10, 12, 14, 17 mm
⊙	13, 14, 17, 18, 19, 21mm
⊗	TX45



**Tool set for plastic oil drain plugs**

CODE	€/Pz
FG 175/S4	70,00



Valid for::  
- VAG TFSI e TDI  
- FORD  
- BMW  
- CITROEN/PEUGEOT



**Set to 3pcs plastic oil drain plugs for VAG TFSI and TDI**

CODE	€/Pz
FG 175/PO	13,50

VAG 1.8, 2.0 TSI/TFSI  
VAG 1.6, 2.0 TDI



**Oil drain plug for FORD**

CODE	€/Pz
FG 175/PO2	13,50

FORD 1.5, 1.6 TDCI  
FORD 1.0, 1.6 EcoBoost  
FORD 1.5 - 5.2 benzina  
FORD 6.2, 6.7, 6.8 diesel



**Oil drain plug for FORD/PSA**

CODE	€/Pz
FG 175/PO1	11,50

FORD 2.0 TDCI  
PSA 2.0 HDI



**Oil drain plug for BMW**

CODE	€/Pz
FG 175/PO3	11,50

BMW 1.6 N13/N20  
BMW 1.6, 2.0 N26



**Universal oil funnel**

CODE	€/Pz
FG 178/UF	60,00



**Special funnel for oil and fluids**

CODE	€/Pz
FG 178/20L	95,00

20 Liters





### Special tools for installing bearings and oil seals

CODE	Ø/mm	€/Pz
FG 178/P1	9.5 - 50	85,00
FG 178/P2	18 - 90	110,00

### Transmission filling system, for gearboxes and differentials

(manual and automatic)

CODE	CAPACITY	€/Pz
FG 176/S13	7.5 Litri	445,00

- Supplied with 12 adaptors
- Equipped of non-Return valve



### Special filling funnel for AdBlue liquid

CODE	CAPACITY	€/Pz
FG 491/AD1	1.1 Litri	35,00
FG 491/AD2	1.1 Litri	36,00



### Fluid syringe

Supplied with 2 spare o-ring

CODE	€/Pz
FG 491/200	37,00

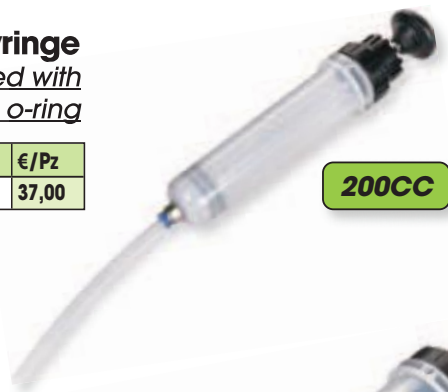

200CC

### In & Out fluid syringe

CODE	€/Pz
FG 491/AD550	125,00

550CC



Equipped with VITON o-ring

CODE	€/Pz
FG 491/1500	82,00

Not suitable for fuels and mineral oils



1.500CC

### Fuel line extraction syringe

CODE	€/Pz
FG 491/DF1500	135,00

Equipped with quick release connectors



1.500CC

### Pressure and depressure tester

CODE	€/Pz
FG 202/PV	220,00



### Airvac coolant refiller

- Purge tapped air from cooling system to eliminate possibility of engine damage due to overheating

CODE	€/Pz
FG 203/S7	160,00



### Radiator cap pressure kit

CODE	€/Pz
FG 203/S20	370,00



21Pz

### OPTIONAL CAPS



FG 203/BW1  
**BMW**



FG 203/FO1  
**FORD Fiesta from 2008**



FG 203/FO2  
**FORD**



FG 203/OP1  
**OPEL**



FG 203/TO1  
**TOYOTA**

CODE	€/Pz
FG 203/BW1	35,00
FG 203/FO1	35,00
FG 203/FO2	35,00
FG 203/OP1	35,00
FG 203/TO1	35,00

### Radiator drain plug tool

CODE	€/Pz
FG 203/A	23,00



3/8"



### Diesel fuel priming set

CODE	€/Pz
FG 201/S7	340,00



- New pump with double directions mode





## Universal injector removal set suitable for Bosch, Delphi, Denso and Siemens





- with hand sliding hammer 4.8KG



CODE	€/Pz
FG 191/S22	600,00

**M18**



CODE	DESCRIPTION		APPLICATION
FG 191/ES-1	Adaptor M14X1.5		Delphi
FG 191/ES-2	Adaptor M16X1.5		
FG 191/ES-3	Adaptor M25X0.5		Denso
FG 191/ES-4	Adaptor M25X0.75		Denso
FG 191/ES-5	Adaptor M27X1.0		Bosch
FG 191/ES-6	Adaptor M16X1.0		Denso
FG 191/ES-7	Adaptor M17X1.0		Bosch
FG 191/ES-8	Adaptor M20X1.0		Denso
FG 191/ES-9	Adaptor M25X1.0		Siemens
FG 191/ES-10	Adaptor M27X1.0		Siemens
FG 191/ES-11	Forch extractor 12 mm		Bosch
FG 191/ES-12	Forch extractor 13.5 mm		Bosch
FG 191/ES-13	Forch extractor 16 mm		
FG 191/ES-14	Forch extractor 26 mm		
FG 191/ES-15	Universal joint		
FG 190/A25	Electronic injector's connection socket 25mm		Siemens
FG 190/A27	Electronic injector's connection socket 27mm		Siemens
FG 190/A29	Electronic injector's connection socket 29mm		Bosch
FG 190/A30	Electronic injector's connection socket 30mm		Bosch
FG 190/EL	Puller for injector's electrodes ø 7.5mm		
FG 190/EL1	Puller for injector's electrodes ø 6.9mm		

**M16**

### Piezo Diesel injector's puller



17mm

CODE	€/Pz
FG 190/AD1	52,00



**M16**

### Bosch Diesel injector's puller



CODE	€/Pz
FG 190/AD2	34,00



### Injector washer extractor

CODE	€/Pz
FG 190/RI	55,00



### Injection nozzle extractor

CODE	€/Pz
FG 190/IP	48,00



### Opel injector extractor for petrol engines with direct injection

CODE	€/Pz
FG 190/OP	45,00

**NEW**





**Diesel Injector Puller M9R -  
Renault / Opel / Nissan**

NEW

CODE	€/Pz
FG 190/RE	235,00



**Sliding hammer for  
diesel injectors' puller**

CODE	€/Pz
FG 190/MI	85,00

M16

170mm



**Sliding hammer for  
diesel injectors' puller**

CODE	€/Pz
FG 190/MI2	96,00

M16

460mm



**Injector puller  
- special for VAG group**

CODE	€/Pz
FG 190/VW	92,00



**Injector pullers for  
BMW N54/MINI N14**

CODE	€/Pz
FG 190/S8	140,00



**Special puller for Diesel  
injector electrodes**

CODE	Ø mm	€/Pz
FG 190/EL	7.5	11,00



**Electronic injector  
connections sockets  
for Bosch and  
Siemens**

CODE	Ø mm		€/Pz
FG 190/A25	25	Siemens	42,00
FG 190/A27	27	Siemens	42,00
FG 190/A29	29	Bosch	42,00
FG 190/A30	30	Bosch	42,00

**Device for testing Common Rail  
diesel electrical injectors**

- 6 bottles  
- for BOSCH, SIEMENS, DENSO e DELPHI

CODE	€/Pz
FG 201/CR	240,00





**FASANO**  
TOOLS

**Diesel injection seat cutter set**

CODE	€/Pz
FG 190/S6B	165,00

**CONTENT:**

- 01 flat cutter 17x19mm
- 01 flat cutter 15x19mm
- 01 flat cutter 17x17mm
- 01 conical cutter 17x21mm
- 01 conical cutter 17x17mm



**Cleaning set for diesel injection seat and diesel spark plugs seat**

CODE	€/Pz
FG 190/S21	340,00

- 1/4"dr. flexible long bit holder
- Brush holder - 1/4"dr.
- Brush - ø 19mm
- Long brush - ø 7mm
- Universal brush
- Caps for central hose

- Caps-holder
- Universal tool for copper seal
- Main tool
- Centering cones
- Side milling tool
- Injector adaptor

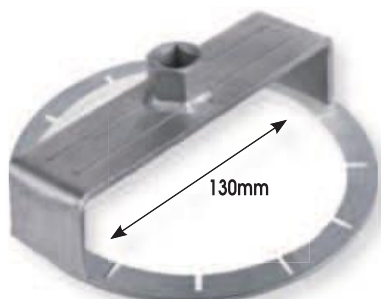

**Wrench for fuel tank floating ring nuts - FCA group**

CODE	€/Pz
FG 174/F2	70,00



**Adjustable wrench for fuel tank floating ring nuts  
Ø 88-170mm**

CODE	€/Pz
FG 174/SC	115,00



**Wrench for fuel tank floating ring nuts**

CODE	€/Pz
FG 175/FT1	65,00

for Fiat, VW, Opel, Mercedes, BMW



**Wrench for fuel tank floating ring nuts**

CODE	€/Pz
FG 175/FT2	80,00

for Citroen and Peugeot

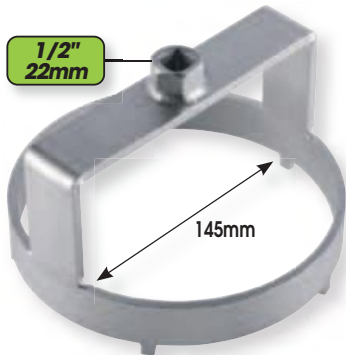

**Wrench for fuel tank floating ring nuts**

CODE	€/Pz
FG 175/FT3	80,00

for FCA (Fiat Freemont, 500L, 500X, Jeep Renegade, ecc)

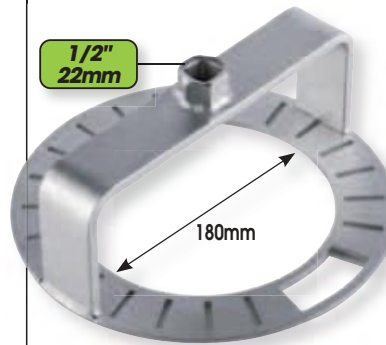

**Wrench for fuel tank floating ring nuts**

CODE	€/Pz
FG 175/FT4	70,00

for VAG group



**Wrench for fuel tank floating ring nuts**

CODE	€/Pz
FG 175/FT5	70,00

for OPEL group



**Diesel fuel filter wrench for HDI**  
- Ø 27mm  
- 1/2" drive

CODE	€/Pz
FG 175/FG3	19,00



**Multijet fuel filter Diesel wrench**  
- Ø 90mm  
- 1/2" drive

CODE	€/Pz
FG 175/FG2	90,00





**Glow plug remover and repair kit**

CODE	€/Pz
FG 182/S16	500,00

M8, M10, MULTIJET

Titanium drills

Centering cone and puller

	CODE	€/Pz
1	FG 72/GMC3	25,80
2	FG 182/S16-ES	62,00
3	FG 182/S16-PR	30,00
4	FG 182/S16-PU10	40,00
5	FG 182/S16-PR2	30,00
6	FG 139/3	1,20
7	FG 182/S16-GU	3,00
8	FG 75/HSS3.5	1,31
9	FG 182/S4-5	4,00
10	FG 182S16/S4-4	22,00
11	FG 182S16/S4-3	25,00
12	FG 182/S16-PU7	40,00
13	FG 182/S16-PU9	40,00
14	FG 72/GMC2	20,10
15	FG 182/S4-1	50,00
16	FG 182/S16-IF14	7,00
17	FG 624L/TX10	9,40
18	FG 72/M8X1	10,10
19	FG 72/M10x1	11,80
20	FG 182/S16-MA14	7,50

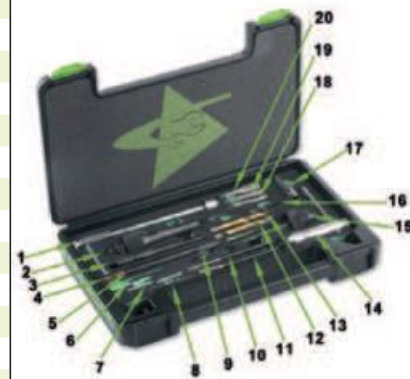

**Set of Diesel engine glow plug socket wrenches**

CODE	€/Pz
FG 183/S5	105,00

8, 9, 10, 12, 14mm



**Spark plug sockets**

3/8"

1/2"

CODE	Ø mm	€/Pz
FG 181/A14	14	18,00
FG 181/A16	16	19,00
FG 181/A18	18(11/16")	22,00
FG 181/A21	21(13/16")	24,00

CODE	Ø mm	€/Pz
FG 181/B14	14	16,00
FG 181/B16	16	17,00
FG 181/B18	18(11/16")	19,00
FG 181/B21	21(13/16")	22,00

1/4"

CODE	Ø mm	€/Pz
FG 183/B8	8	30,00
FG 183/B9	9	30,00
FG 183/B10	10	30,00
FG 183/B12	12	30,00
FG 183/B14	14	30,00

**Spark plug sockets - special for BMW**

CODE	€/Pz
FG 181/C14	27,50

14mm

3/8"



3/8"

**Spark plug sockets - 12PT**

CODE	Ø mm	L/mm	€/Pz
FG 181/RE1	14	250	38,50
FG 181/RE2	16	250	38,50

- 14mm: BMW Mini, Citroën, Peugeot, Renault e Mercedes  
- 16mm: BMW, Vauxhall/Opel, Jaguar e giapponesi



**Set of 2pcs spark plug sockets - 12PT**

CODE	CONTENT	€/Pz
FG 181RE/S2	14, 16 mm	77,00



**Handle wrenches for spark plugs**

CODE	Ø mm	€/Pz
FG 181T/A14	14	52,00
FG 181T/A16	16	53,00
FG 181T/A21	21	65,00

**Set of 3 Handle wrenches for spark plugs**

CODE	€/Pz
FG 181/S3	170,00



- 14mm  
- 16mm  
- 21mm

### Threaded coil insert repair set

- M14x1.25

CODE	€/Pz
FG 181/S17	115,00

### Insert coils

CODE	Ø mm	Min.	€/Pz
FG 193/M5	M5x0.8	50	0,60
FG 193/M6	M6x1.0	50	0,70
FG 193/M8	M8x1.25	50	0,80
FG 193/M10	M10x1.5	50	0,90
FG 193/M12	M12x1.75	25	1,20
FG 193/M14	M14x1.25	25	1,50

### Threaded coil insert repair set

CODE	€/Pz
FG 181/S130	275,00

- M5x0.8
- M6x1.0
- M8x1.25
- M10x1.5
- M12x1.75

CODE	€/Pz
FG 181/S115	360,00

- M6x1.0
- M8x1.25
- M10x1.5
- M12x1.75
- M14x1.25



### Metric feeler gauges

CODE	Blades	mm	€/Pz
FG 188/1	13	0.05 - 1.00	14,50
FG 188/2	20	0.05 - 1.00	19,50

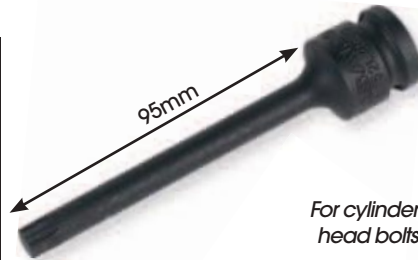

### Impact extra-long socket bit - XZN9

For cylinder head bolts

CODE	€/Pz
FG 152L/RM9	22,00

### Sockets for lambda probe

CODE	mm	L/mm	€/Pz
FG 183/B85	22	85	38,00
FG 183/B110	22	110	46,00



### Valve spring compressor

FOR BMW, MINI, CITROEN, PEUGEOUT

CODE	€/Pz
FG 190/SV2	400,00

### Piston ring pliers

CODE	Ø mm	€/Pz
FG 197/B1	50-100	30,00
FG 197/B2	80-120	32,00
FG 197/B3	110-160	37,00

### Piston ring compressors

CODE	Ø mm	€/Pz
FG 197/A3	50-100 x 76H	34,00
FG 197/A4	80-120 x 10H	40,00
FG 197/A6	110-160 x 152H	58,00



### Valve spring compressor kit

CODE	€/Pz
FG 190/SV	130,00





**Socket for CNG valve tank**

CODE	€/Pz
FG 800/2	120,00

FIAT MULTIPLA e PUNTO  
(VBE 517, VBE 520, VBE 474 e VALE 110)

36mm



**Socket for CNG valve tank**

CODE	€/Pz
FG 800/5	120,00

For Opel ZAFIRA

36mm



**Socket for CNG valve tank**

CODE	€/Pz
FG 800/3	120,00

FIAT PANDA, PUNTO EVO,  
VOLKSWAGEN

32mm

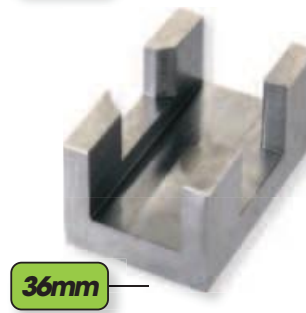

**Socket for CNG valve tank**

CODE	€/Pz
FG 800/6	120,00

For MCR 110 valves

36mm



**Socket for CNG valve tank**

CODE	€/Pz
FG 800/7	120,00

FIAT PANDA

36mm



**Socket for CNG valve tank**

CODE	€/Pz
FG 800/8	120,00

For Citroen C4 Picasso

36mm



**Battery liquid tester**

CODE	€/Pz
FG 172/BL	27,00

380mm



**Socket for LPG valve tank - VAG group**

CODE	€/Pz
FG 800/9	145,00

1/2"



**Special tester kit for TURBO system control**

CODE	€/Pz
FG 189/S13	230,00



- 31, 38 46, 51, 55, 60, 65, 70, 75, 80, 85, 90mm

**Universal tools for expanding air bag**

CODE	€/Pz
FG 185/S12	75,00



**Fuel and air condition line disconnect set**

CODE	€/Pz
FG 185/S27	112,00





**Set of 04pcs  
ignition pullers**

CODE	€/Pz
FG 195/S4B	90,00

**Ignition puller  
- Volkswagen group**

CODE	€/Pz
FG 195/VW	22,50



**Alternador pulley free  
wheel wrench - Renault**

CODE	€/Pz
FG 179/H28	13,00



**Alternador pulley free  
wheel wrench  
- Nippodenso**

CODE	€/Pz
FG 179/H32	15,00

19.45mm



**Alternador pulley free  
wheel wrench - BOSCH**

CODE	TEETH	•	€/Pz
FG 179/PA20	33	17mm	15,50

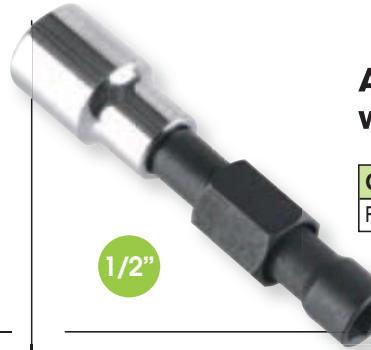

**Alternador pulley free  
wheel wrench**

CODE	€/Pz
FG 179/H10	24,00



**Alternador pulley free  
wheel wrench**

CODE	TX	€/Pz
FG 179/T50	TX50 - 31 TEETH	29,00

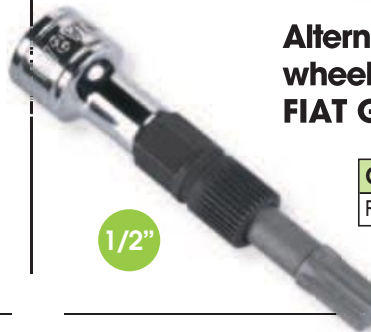

**Alternador pulley free  
wheel wrench  
FIAT GRANDE PUNTO**

CODE	€/Pz
FG 179/GP	29,00



**Tool set for alternators  
pulley free wheels**

CODE	€/Pz
FG 179/S16	155,00



**Universal clutch  
alignment kit**

CODE	€/Pz
FG 180/S12	82,50

Centerings' sizes:  
12-20mm







**Clutch alignment tools for SAC**

- 01 3-Arm Plate
- 01 4-arm plate
- 06 conical centers (15x23, 15x28, 15x34, 15x26.5, 15x32.5, 15x32.5mm)
- 09 centering pins (12, 14, 15, 15/22, 16, 17, 18, 19, 22/28mm)

CODE	€/Pz
FG 180/S38	700,00



**Dual mass flywheel special tool set (DMF)**

CODE	€/Pz
FG 180/S17	590,00



**12V extractor for brake fluid**

- 12V power supply via battery cables
- equipped with rear compartment door and oil recovery container
- equipped with liquid sensor
- adjustable pressure till 2 Bar
- Tank capacity: 5 liters
- Stainless steel body

CODE	€/Pz
FG 178/SF	1.760,00



**Specific caps for FORD motors**

CODE	€/Pz
FG 178SF/AD13	55,00
FG 178SF/AD14	55,00

**OPTIONAL**



**FG 178SF/AD13**  
Fiesta 2011-2016



**FG 178SF/AD14**  
Mondeo dal 2014  
Fiesta dal 2016  
Mazda CX3/CX5

**2 universal caps included**



42mm

44,45,46mm

**Set of special caps for asian vehicles**

CODE	€/Pz
FG 178/S6	330,00

- Toyota
- Hyundai
- Nissan
- Mitsubishi
- Mazda
- Subaru
- Honda
- Suzuki



**Pneumatic extractor for blade fluids**

CODE	€/Pz
FG 178/BF	255,00

- Capacity: 2 Liters
- Equipped with universal couplings



**Manual/Pneumatic fluid extractor**

CODE	€/Pz
FG 492/AL	245,00

- Capacity: 9 Liters
- Equipped with universal couplings



**Pneumatic wind back kit for disc brake pistons**

CODE	€/Pz
FG 199/PF	220,00



For left and right calipers



**Adaptor for worn calipers**

CODE	€/Pz
FG 199/PFP	22,00



FG 199/PM3

FG 199/PM2

FG 199/PM1

**Drum brake spring pliers**

CODE	L/mm	€/Pz
FG 199/PM1	210	35,00
FG 199/PM2	330	42,00
FG 199/PM3	540	112,00

**Extraction syringe for brake fluid**

Capacity: 200CC  
Equipped with specific fittings for brake circuit  
Internal VITON gasket

CODE	€/Pz
FG 199/SF	60,00



**Drum brake spring clamp pliers**

CODE	€/Pz
FG 199/FM	30,00

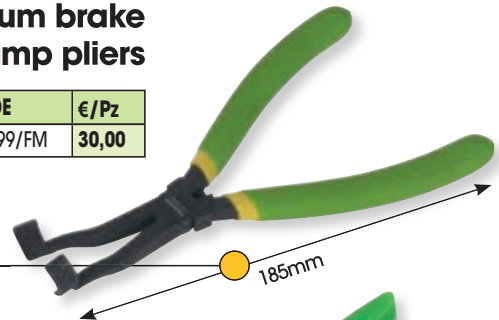

**Locking ring pliers**

CODE	€/Pz
FG 165/FC	48,00



**Drum brake spring pliers**

CODE	€/Pz
FG 199/A	52,00

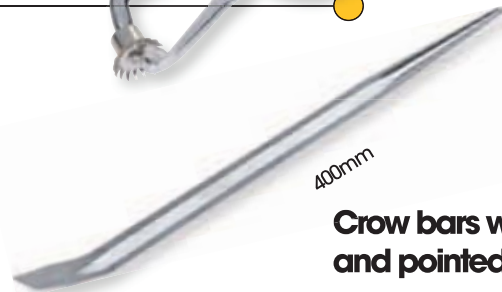
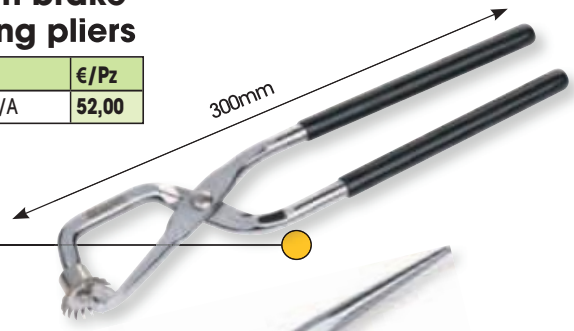

**Crow bars with closed and pointed edges**

CODE	€/Pz
FG 125/B400	25,00

**Brake caliper tool set**

CODE	€/Pz
FG 198/S11	135,00

BMW, Ford, VAG  
Mercedes



**Special socket for brake caliper**

CODE	€/Pz
FG 198/B7	16,50
FG 198/B9	16,50



NEW



**Digital depth gauge for tyre threads**

CODE	€/Pz
FG 198/DG	33,00





## Hub impact socket bits

CODE	mm	€/Pz
FG 152/RM12	12	13,50
FG 152/RM14	14	13,50
FG 152/RM16	16	13,50
FG 152/RM18	18	13,50

1/2"



## Set of 4pcs hub nut socket bits

CODE	€/Pz
FG 152RM/S4	77,00

- M12, M14, M16, M18



## Hub nut socket IVECO

CODE	€/Pz
FG 198/B4	98,00

3/4"



## Hub nut socket 6PT

CODE	mm	€/Pz
FG 197/A36	36	40,00

3/4"

## Hub nut socket 12PT

CODE	mm	€/Pz
FG 197/B36	36	40,00

3/4"



## Deep impact sockets for aluminum wheels

CODE	mm	€/Pz
FG 628R/L17	17	26,00
FG 628R/L19	19	26,00
FG 628R/L21	21	26,00

1/2"



CODE	Pz	CONTENT	€/Pz
FG 628L/S3	3	17, 19, 21mm	98,00



## Hub nut sockets

CODE	mm	Ø OUTSIDE	€/Pz
FG 198/A30	30	42mm	32,00
FG 198/A32	32	44mm	32,00
FG 198/A34	34	47mm	32,00
FG 198/A35	35	49mm	34,00
FG 198/A36	36	50mm	38,00

1/2"



## Hub nut sockets for Iveco Daily

CODE	mm	Ø OUTSIDE	€/Pz
	65	87	70,00

1"



## Deep impact sockets for aluminum wheels

CODE	mm	€/Pz
FG 628/R15	15	15,50
FG 628/R17	17	15,50
FG 628/R19	19	15,50
FG 628/R21	21	16,00
FG 628/R22	22	17,00

CODE	Pz	CONTENT	€/Pz
FG 628/S3	3	17, 19, 21mm	50,00
FG 628/S5	5	15, 17, 19, 21, 22mm	78,00



1/2"



## Set 3pcs deep impact sockets for aluminum wheels + adaptors for damaged nuts

CODE	€/Pz
FG 628/S7	115,00

NEW



**Deep impact sockets for aluminum wheels**

CODE	mm	€/Pz
FG 627/R17	17	28,00
FG 627/R19	19	28,00
FG 627/R21	21	28,00

1/2"



CODE	Pz	CONTENT	€/Pz
FG 627/S3	3	17, 19, 21mm	85,00

**Tyre valve lever**

CODE	€/Pz
FG 126/VP	21,50

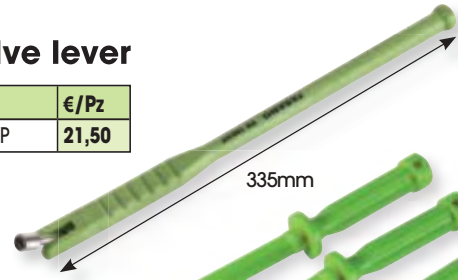

**4pcs nylon levers set**

CODE	€/Pz
FG 186P/S4	23,00



**ANTITHEFT WHEEL NUTS TOOL SET**

**Impact socket for wheel nuts - FORD**  
Size: 18.5x19.5mm  
Internal square drive: 1/2"

CODE	€/Pz
FG 628/R18.5	20,00



**Wheel balancing weight pliers**

CODE	€/Pz
FG 65/SR250	32,50



**Pliers for removing wheel balancing adhesive weights**

CODE	€/Pz
FG 198/PE	60,00



NEW



**Antitheft wheel nuts tools set - BMW**  
Equipped with sliding hammer and ABS box

CODE	€/Pz
FG 164/S3	250,00

**Antitheft wheel nuts tool set - BMW**

CODE	€/Pz
FG 164/S3B	165,00

To be used with hammer  
FG 190/MI  
FG 190/MI2



CODE	APPLICATION	€/Pz
FG 164/A	BMW	130,00



CODE	APPLICATION	€/Pz
FG 164/C	BMW	240,00
FG 164/D	Volkswagen	246,00
FG 164/E	Audi	260,00



Do not use with screwdrivers percussion

**Universal desmounting set for antitheft wheel nuts**

CODE	€/Pz
FG 164/S10	175,00





**Tyre lever for aluminum wheels**

CODE	€/Pz
FG 126/P500	45,00

**Tyre lever**

CODE	L/mm	€/Pz
FG 126/A300	300	18,00
FG 126/A500	500	33,00
FG 126/A600	600	42,00

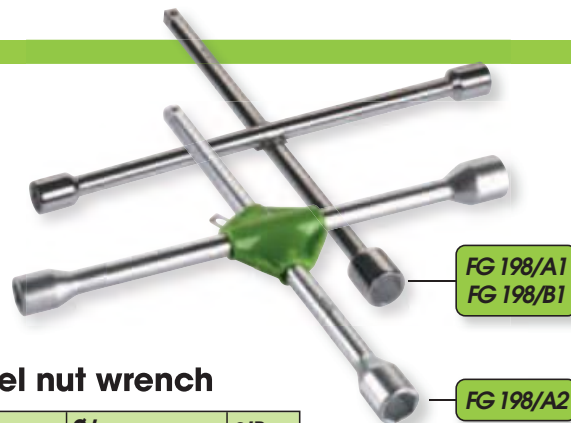

**Wheel nut wrench**

CODE	Ø/mm	€/Pz
FG 198/A1	17x19x22x1/2"	36,00
FG 198/B1	24x27x32x3/4"	125,00
FG 198/A2	17x19x22x1/2"	36,00

**Brushless impact wrench, 18V**

CODE	€/Pz
FG 166/LT2	920,00

**18v-5.0A**

**Mar Torque**

**2.900**

**1.000 Nm**

**650**



**BRUSHLESS MOTOR**

Supplied with 2 battery packs and 1 charger



**L mode:** -900RPM -1.200 strokes for minutes  
**M mode:** -1.200RPM -1.600 strokes for minutes  
**H mode:** -1.900RPM -2.400 strokes for minutes  
**Soft mode:** allows a controlled speed to be applied until the bolt is still locked

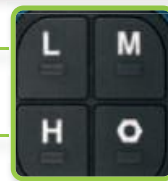

**Brushless impact wrench, 18V (with 1 battery pack)**

CODE	€/Pz
FG 166/LT	750,00

**Li-Ion battery pack 5.0Ampere, 18 Volt**

CODE	€/Pz
FG 166/BA	250,00



**Charger for FG 166/BA**

CODE	€/Pz
FG 166/CB	70,00





**Shock absorber spring compressors - with 2 extra bars**

CODE	L/mm max	€/Pz
FG 159/PM	65 - 200mm / 65 - 370mm	220,00



**Set of 5 sockets for shock absorber nuts**

CODE	€/Pz
FG 159/S5	55,00

- 10.5x3.5
- 12.5x3.5
- 14x2.5
- 14x3
- 14.5x5



**Ball joint socket - PSA group**

CODE	Ømm	€/Pz
FG 169/A44	44	55,00

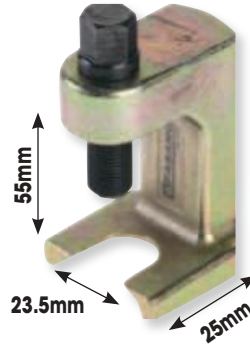

**Ball joint puller**

CODE	€/Pz
FG 168/E	95,00

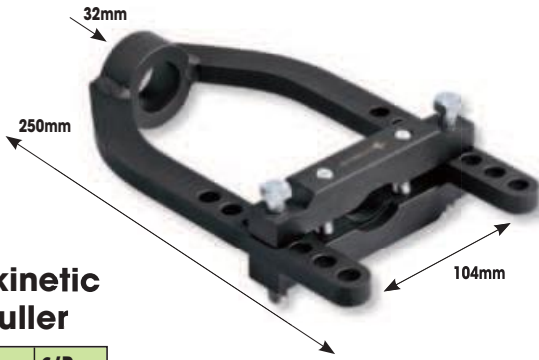

**Homokinetic joint puller**

CODE	€/Pz
FG 165/GO1	180,00

**Ball joint pullers**

CODE	Ømm	€/Pz
FG 168/1	18	52,00
FG 168/2	25	65,00
FG 168/3	30	98,00
FG 168/4	40	130,00



**Ball joint pullers**

CODE	€/Pz
FG 169/FO1	43,00
FG 169/FO2	43,00
FG 169/FO3	43,00



**Homokinetic joint tool**

CODE	€/Pz
FG 165/GO2	150,00

**NEW**

**Ball joint puller**

CODE	Ømm	€/Pz
FG 169/1	19	60,00
FG 169/2	22	78,00

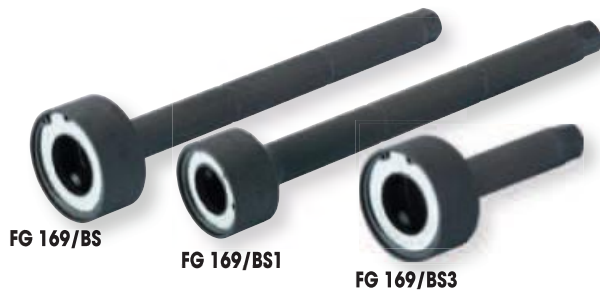

**Special tool for installing and removing steering arms**

CODE	Ø/mm	Ø mm OUTSIDE	●/mm	L/mm	€/Pz
FG 169/BS	35 - 45	89	1/2" o 27mm	400	125,00
FG 169/BS1	28 - 35	73	1/2" o 27mm	400	115,00
FG 169/BS3	35 - 45	89	1/2" o 27mm	195	115,00

**Ball joint pullers**

CODE	Ømm	€/Pz
FG 169/3	23	140,00





**Special tool set for installing and removing SILENT BLOCK**

CODE	€/Pz
FG 165/S26	700,00

- sockets for Ø 44-82mm
- 4 threaded bars M10, M12, M14, M16



**Hydraulic wheel hub puller**

CODE	€/Pz
FG 198/DF	350,00

- Plate with 10 holes
- Usefull till M12



**Special tool set for installing and removing SILENT BLOCK Fiat Panda 4x4 and Panda CNG**

CODE	€/Pz
FG 165/S7	175,00



**Special tools for installing and removing wheel bearings**

CODE	€/Pz
FG 166/S28	460,00

- instalSideon Ø 34-45mm
- disinstalSideon Ø 60-84mm

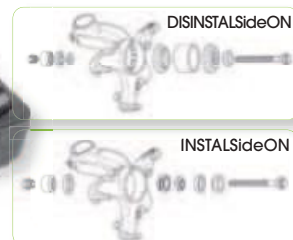

**Inner bearing puller set**

CODE	€/Pz
FG 166/S7	600,00

- Pliers: Ø 40-45mm, 45-51mm, 50-55mm, 55-61mm
- Wrenches: Ø 82.7mm, 58.9mm



**Crimping pliers set + Weather pack terminals**

CODE	€/Pz
FG 185/S190	150,00

### Lower engine bracket

CODE	L/mm	€/Pz
FG 213/SM	1.050	690,00



### Lower engine bracket

CODE	L/mm	€/Pz
FG 213/SM1	1.100	590,00

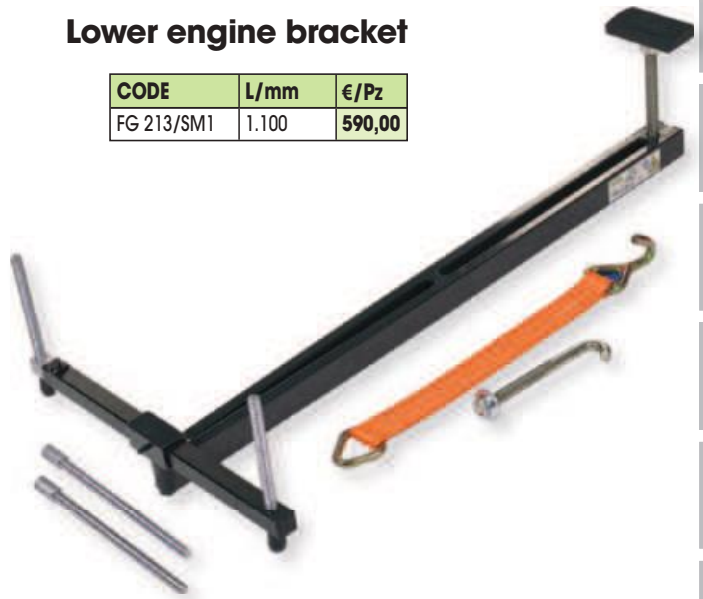

Useful to support the engine or gearbox during maintenance work (shift belt, clutch, alternator, water pump, etc.) of car and commercial vehicles.

Special extended version, which can also be used on gearboxes particularly wide



Extensions included

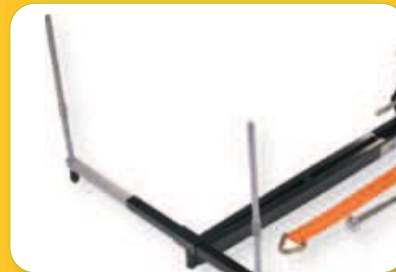

### Lever for pulling arm and shock absorbers

CODE	L/mm	€/Pz
FG 213/LT	750	310,00



### Transmission support

CODE	€/Pz
FG 213/SU	590,00



Equipped with adaptor for under bridge jack Ø 25-30-35-45mm

Suitable for passenger cars and commercial vehicles





### Chain pin remover&installer

CODE	€/Pz
FG 172/TC	54,00



### Hose clip pliers

CODE	€/Pz
FG 172/CL	48,50



### Hose clip pliers

CODE	€/Pz
FG 172/FA	70,00



### Automatic hose ring pliers with interchangeable cables

CODE	CAPACITY	€/Pz
FG 172/AS2	3 - 52mm	108,00



### Interchangeable cables

CODE	CAPACITY	€/Pz
FG 172/AS2-A	3 - 52mm	26,00
FG 172/AS2-B	0 - 75mm	50,00
FG 172/AS2-C	0 - 24mm	30,00
FG 172/AS2-D	Per connettori carburante	33,00

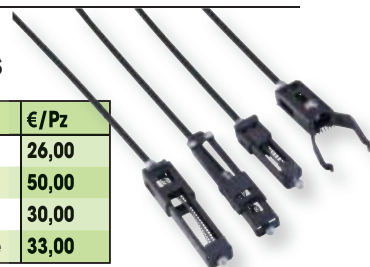

### Flug flanger pliers

CODE	€/Pz
FG 172/GO2	105,00



### Flug flanger pliers

CODE	€/Pz
FG 172/OT	54,00



**CV clamp banding tool with cutter**

CODE	Ø/mm	€/Pz
FG 172/PA	4.7 - 9.5	65,00

For Panduit ties



**Hose removal pliers**

CODE	€/Pz
FG 172/TG	49,50



**Fuel feed pipe pliers**

CODE	€/Pz
FG 171/N	28,50



**Quick coupler swivel pliers for fuel pipes, with articulated jaws**

CODE	€/Pz
FG 171/FL	50,00

**NEW**



**Wedges for releasing diesel fuel filter fittings**

CODE	€/Pz
FG 172/S4	48,00



**Valve seal removal pliers**

CODE	€/Pz
FG 174	38,00



**Plastic hose pliers**

CODE	Ø mm	€/Pz
FG 170/1	8-15	13,50
FG 170/2	15-25	15,50
FG 170/3	25-45	17,50



**Set of 3 plastic hose pliers**

CODE	€/Pz
FG 170/S3	48,00

**Fuel feed pipe pliers**

CODE	€/Pz
FG 171/B	40,00



**Fuel feed pipe pliers**

CODE	€/Pz
FG 172/MJ	25,00

For MULTIJET



**External butt-ended circlip pliers**

CODE	CAPACITY'	€/Pz
FG 55/SP	30 - 100mm	45,00

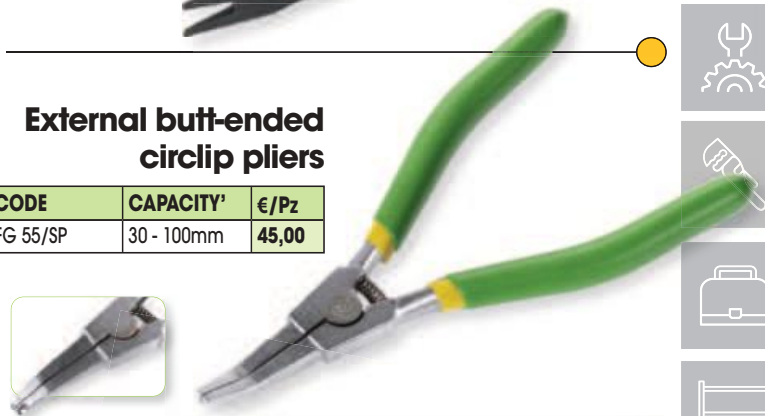

**Spark-plug pliers**

CODE	Ø	€/Pz
FG 172/CA	14mm	56,00

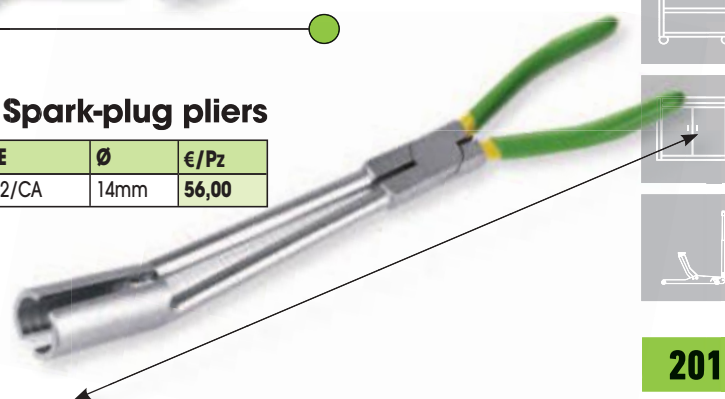

### Special tool for Opel nozzle adjusting

CODE	€/Pz
FG 195/U	11,00

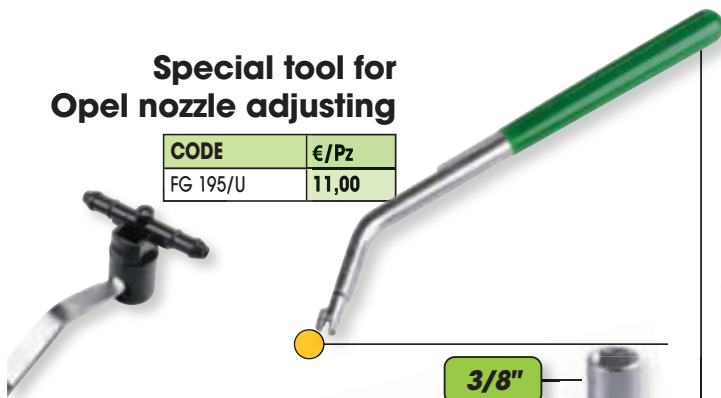

3/8"

### Turbo charger wrench

CODE	€/Pz
FG 196/A12	27,00

22mm

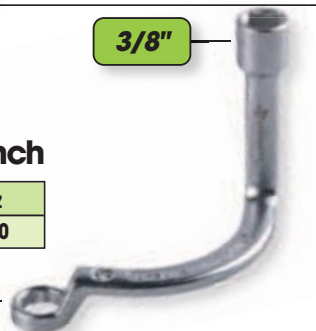

### Relay removal pliers

CODE	Ø	€/Pz
FG 172/RL1	15 - 50mm	22,00



### Relay removal pliers

CODE	Ø	€/Pz
FG 172/RL2	15 - 50mm	24,00

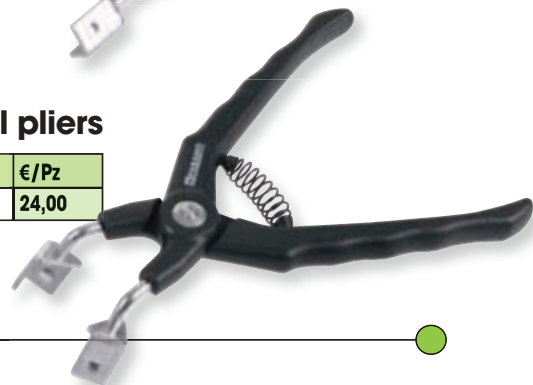

### Start booster

CODE	VOLT	PICKUP CURRENT	€/Pz
FG 99	12	2.000A	550,00
FG 99/B	12	2.500A	670,00
FG 99/C	12 - 24	5.000A (α 12V)-2.500A (α 24V)	1.900,00

#### TECHNICAL FEATURES

- Sealed lead acid battery (AGM)
- Current: 220V and 12V



### Set service for garage

CODE	€/Pz
FG 141010	300,00

#### Parts:

CODE	DESCRIPTION	€/Pz
FG 141015	50pcs set seat covers	80,00
FG 141065	50pcs set carpet covers - 450x350mm	30,00
FG 141060-BO	Steering wheels film cover	10,00
FG 141060-MA	Lever	12,00





**Timing chain splitting and fitting tool kit**

CODE	€/Pz
FG 184/S24	450,00



**Set for locking of pulley puller**

CODE	€/Pz
FG 184/BP	210,00

**Damper pulley puller holder wrenches**

CODE	Ø/mm	€/Pz
FG 184/B13	13	28,00
FG 184/B15	15	28,00
FG 184/B16	16	28,00
FG 184/B17	17	28,00
FG 184/B19	19	28,00



CODE	€/Pz
FG 184/FT1	70,00

**Belt tensioner wrench  
FIAT, Ford, Citroen, Peugeot**



**Set of damper pulley puller holder wrenches**

CODE	CONTENT	€/Pz
FG 184/S5	13, 15, 16, 17, 19mm	150,00
FG 184TX/S5	E10, E12, E14, E16, E18	170,00



**Set of damper pulley puller holder wrenches**

CODE	€/Pz
FG 184/S6	95,00

*Content:*  
- TX40, TX45, TX60  
- H8, H10



**Ribbed drive pulley puller**

CODE	€/Pz
FG 181/PM	148,00

- Capacity: 30 -157mm  
- Step throat: 3.56mm



**Ribbed drive pulley puller**

CODE	€/Pz
FG 181/PM2	90,00

**NEW**

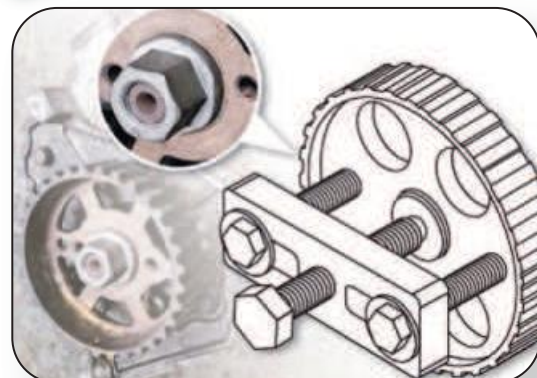



### Digital compression tester

**Technical features:**

- precision: 1%FS
- software in 7 languages (IT, EN, DE, FR, ES, PT, GR, PL)
- touch screen LCD display, 4,3"



CODE	€/Pz
FG 215	950,00

**Accessories included:**

- 0-80 bars sensor
- Terminals for 12V battery connection
- kit of couplings + hose for petrol system
- hose for Diesel system



FG 215 allows to test the compression power of **Diesel** and **Petrol** systems. Designed, engineered and manufactured entirely in **Italy!**

**Principal menu of FG 215**

**ALTERNATOR TEST FUNCTION**

**PROVE DI PRESSIONE SU CILINDRI**

**Dati Cliente**  
Nome: FLORIANO Cognome: CAMPA Luogo e Data di Nascita:

**Dati Autoveicolo**  
Marca: Mokka Anno: Targa:

**Dati Misurazione**

Misura Esigete - I valori minimi sono evidenziati in rosso				
N. Cil.	C1	C2	C3	C4
P/(BAR)	14,0	15,0	15,8	16,0
Tens.(V)	10,0	11,0	11,8	11,0

Data: 09/10/2014 11:04:00 Firma e Timbro:

**COMPRESSIION TEST & BATTERY TENSION TEST**

**Able to download and store datas into PC, personalizing the data sheet with the informations of own garage and own customers**



**Set of fake glow plugs, injectors and fake adaptors for Petrol system**

CODE	€/Pz
FG 215/S39	600,00

**Glow plug adaptors**



CODE	SIZE	L/mm	€/Pz
FG 215/CA1	12x1.25	17.5	26,00
FG 215/CA2	12x1.25	20.0	27,00
FG 215/CA3	10x1.25	28.5	27,00
FG 215/CA4	10x1.25	42.0	30,00
FG 215/CA5	10x1.25	45.0	30,00
FG 215/CA6	10x1.25	44.0	30,00
FG 215/CA7	10x1.0	54.0	30,00
FG 215/CA8	10x1.0	43.0	30,00
FG 215/CA9	12x1.25	26.0	30,00
FG 215/CA10	10x1.25	32.0	32,00
FG 215/CA11	10x1.0	35.0	32,00
FG 215/CA12	12x1.25	58.0	33,00
FG 215/CA13	10x1.0	71.0	34,00
FG 215/CA14	10x1.0	59.0	35,00
FG 215/CA15	8x1.0	61.0	35,00

CODE	SIZE	L/mm	€/Pz
FG 215/CA16	10x1.25	85.0	40,00
FG 215/CA17	10x1.0	80.0	55,00
FG 215/CA19	10x1.25	102.0	56,00
FG 215/CA20	9x1.0	88.0	40,00
FG 215/CA21	10x1.25	85.0	55,00
FG 215/CA22	10x1.0	73.0	52,00

**90° adaptor**

CODE	€/Pz
FG 215/AD90	33,00



**High pressure hose complete of quick coupling**

CODE	€/Pz
FG 215/TU	105,00

**Injector adaptors**

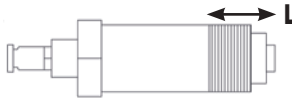

CODE	SIZE	L/mm	€/Pz
FG 215/FI23	22x1.5	43.0	42,00
FG 215/FI24	24x1.5	28.0	48,00
FG 215/FI25	20x1.5	29.0	54,00
FG 215/FI26	24x2.0	26.0	55,00



**Adaptors for truck, marine and agriculture**

CODE	€/Pz
FG 215MP/S9	195,00

**Hose for petrol vehicles**

CODE	€/Pz
FG 215TU/BE	40,00



**Fake spark plugs for petrol vehicles**



CODE	SIZE	€/Pz	CODE	SIZE	€/Pz
FG 215BE/M10	M10	11,00	FG 215BE/M14F	M14 - FORD ZETEC	22,00
FG 215BE/M12	M12	11,00	FG 215BE/M16	M16	11,00
FG 215BE/M14	M14	11,00	FG 215BE/PR	Prolunga universale	70,00





**Accessories included**



**Digital compression tester**

Complete with fake injectors and fake glow plugs for Diesel systems

CODE	€/Pz
FG 215/S40	1.550,00

FG 215 allows to test the compression power of **Diesel** and **Petrol** systems. Designed, engineered and manufactured entirely in **Italy!**

**ALTERNATOR TEST FUNCTION**

Principal menu of FG 215

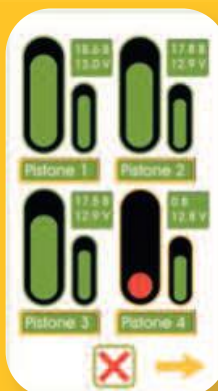

**COMPRESSION TEST & BATTERY TENSION TEST**

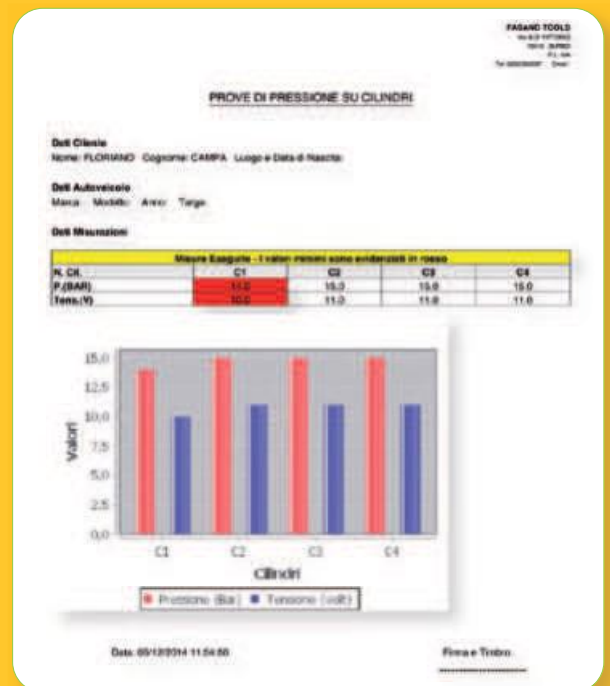

Able to download and store datas into PC, personalizing the data sheet with the informations of own garage and own customers



## Multi-function digital tester for engine compression, fuel pressure and engine oil pressure

### Technical features:

- precision: 1%FS
- software in 8 languages (IT, EN, DE, FR, ES, PT, GR, PL)
- touch screen LCD display, 4.3"
- sensors 0-80Bar and 0-2.500Bar

CODE	€/Pz
FG 219/S	3.200,00



Able to download and store data into PC, personalizing the data sheet with the informations of own garage and own customers



**ALTERNATOR TEST  
ENGINE COMPRESSION TEST  
BATTERY TEST**



**FUEL PRESSURE TEST  
(HIGH and LOW PRESSURE)**



**OIL PRESSURE TEST**



CODE	€/Pz
FG 220/BT	420,00

**NEW**

## 12v and 24v automotive storage battery tester

### Technical Features:

Dimensions: 90X50X235 mm  
Operating voltage: from 9V to 35V DC  
Battery check time: about 1 minute  
Internal battery for date and time memory:  
CR1220 (1 piece)



<b>FEATURES:</b>	BACKLIT DISPLAY
	LANGUAGES: Italian; Spanish; Polish; English; German; French
	REPORT PRINTING BOX
	FALSE DETECTION SYSTEM COLLET CONNECTION CONTACT
<b>APPLICATIONS:</b>	STORAGE BATTERY TESTER 12 E 24V
	ALTERNATOR TEST (INTELLIGENT AND NORMAL) 12-24V LOAD
	STARTING SYSTEM TEST
<b>BATTERIES SUPPORTED:</b>	PB, WET, GEL AGM, AGM FLAT, EFB
<b>APPLICATIONS:</b>	CCA: 100-1700; IEC: 100-1000; EN: 100-1700; DIN: 100-1000; JIS
<b>CABLE LENGTH:</b>	570 mm





# TIMING TOOLS SET

## INSTRUCTIONS

In each User Manual there's the correspondece between **FASANO tools** and OEM tools. This feature permits a fast research and using of each individual tools

## SPARE PARTS

**FASANO Tools** permits to buy the complete set available on the Catalogue and also individual tools which compose each set

## TOOL FINDER

In the home of webiste [www.fasanotools.com](http://www.fasanotools.com) it's possible to use a fast research tool only writing the most important datas of veichule.



IN COOPERATION WITH:  
**Autodata**  
It's what we know

Autodata non è responsabile per l'uso improprio di informazioni tecniche allegate ai prodotti FASANO Tools



### Timing tool set for BMW 2.0 N47, N47S, N57 - chain

**Models:**  
118D(E81/E87); 120D(E81/E82/E87);  
123D(E81/E82/E87); 318D(E90/E91);  
320D(E90/E91/E92); 520D(E60/E); X3 2.0D(E83)

**Engines:** 1.6D, 2.0D, 3.0D  
**Motor codes:** N47, N47S, N57

CODE	€/Pz
FG 192/BW4	180,00

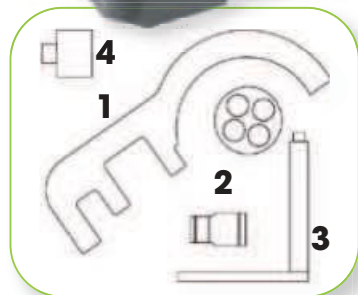

CODE	DESCRIPTION	€/Pz
1: FG 192/BW4-1	Attrezo di allineamento alberi a camme	69,80
2: FG 192/BW4-2	Attrezo per la rotazione puleggia albero motore	58,20
3: FG 192/BW4-3	Perno di fasatura volano/piastra di comando	17,50
4: FG 192/BW4-4	Attrezo smontaggio pignone pompa carburante alta pressione	32,00

### Puller for injection pump pulley - BMW

**Motor codes:** M41, M51

CODE	€/Pz
FG 192/BW1	42,00



### Puller for injection pump pulley - BMW

**Motors:** M47, M47TU, M57, M57TU

CODE	€/Pz
FG 192/BW2	55,00



CODE	€/Pz
FG 192/BW16	250,00



### Balance alignment tool for BMW e MINI B47, B48

**BMW:** Serie 1, Serie 2 Active Tourer, Serie 2 Cabriolet, Serie 2 Coupe, Serie 2 Gran Tourer, Serie 3, Serie 3 Gran Turismo, Serie 4 Cabriolet, Serie 4 Coupe, Serie 4 Gran Coupe, Serie 5, X1, X3, X4, X5

**MINI:** Clubman, Mini Hatch, Clubman, Convertible, Countryman

**Engines:**  
2.0 D; 2.0 benzina

**Motor codes:**  
2.0 D: B47; B47 C20A; B47 C20B; B47 D20A; B47 D20B  
2.0 benzina: B48 A20A; B48 A20B; B48 B20A; B48 B20B



### Crankshaft holding tool for N47/N47S/N57 BMW engines



**Models:**  
118D(E81/E87);120D(E81/E82/E87);123D(E81/E82/E87);  
318D(E90/E91); 320D(E90/E91/E92); 520D(E60/E); X3 2.0D(E83)

**Engines:** 1.6D, 2.0D, 3.0D  
**Motor codes:** N47, N47S, N57

CODE	€/Pz
FG 192/BW3	54,00



### Balancer shaft timing tools suitable for BMW (N47/N47S)



**Models:**  
118D(E81/E87);120D(E81/E82/E87);123D(E81/E82/E87);  
318D(E90/E91); 320D(E90/E91/E92); 520D(E60/E); X3 2.0D(E83)

**Engines:** 1.6D, 2.0D  
**Motor codes:** N47, N47S

CODE	€/Pz
FG 192/BW4B	340,00



### Timing tool set for BMW-MINI B37/B47 1.5, 2.0 Diesel (Timing chain)



**Models:**  
BMW: 214d; 216d; sDrive 16d; 114d; 116d; xDrive25d; 218d;  
220d; sDrive 18d; xDrive 18d; xDrive 20d; 316d; 318d; 418d;  
420d; 518d; 225d;  
MINI: Mini Hatch; One D; Convertible; Cooper D; Cooper SD

**Engines:** 1.5, 2.0  
**Motor codes:** B37 C15A; B37 D15A; B47  
C20A; B47; B47 D20A; B47 D20B

CODE	€/Pz
FG 192/BW9B	480,00

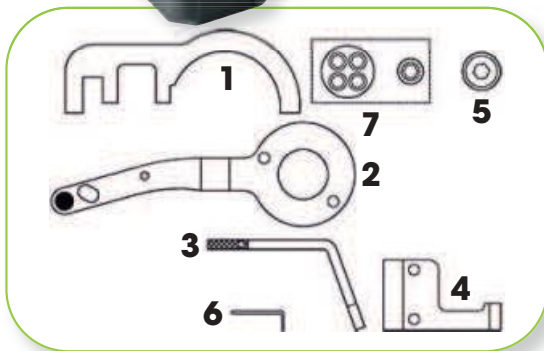

CODE	DESCRIPTION	€/Pz
1: FG 192/BW4-1	Camshaft alignment tool	69,80
2: FG 192/ BW9B-2	Crankshaft holding tool	140,00
3: FG 192/ BW9B-3	Flywheel/drive plate timing pin	30,00
4: FG 192/ BW9B-4	AT: Drive plate timing pin adapter	120,00
5: FG 192/BW4-4	High-pressure fuel pump sprocket removal tool	32,00
6: FG 192/ BW9B-6	Tensioner locking pin	5,00
7: FG 192/BW4-2	Crankshaft pulley turning tool	58,20



### Crankshaft turning tool & flywheel holding tools for BMW-MINI B37/B47 1.5, 2.0 Diesel

CODE	€/Pz
FG 192/BW4C	140,00





**Timing tool set for BMW M47 /M57  
LAND ROVER 2.0 - 3.0 Diesel TD4/TD6; OPEL 2.5 D**



**Models:**

**BMW M47/M47TU:** 120d, 318d, 318td Compact, 320d, 520d, X3  
**BMW M57/M57TU:** 330d,335d,530d,535D,635d,730d,X3,X5,X5D Turbo,X6  
**LAND ROVER:** Freelander (Td4) 2000-2006; **Range Rover:** Td6 (02-13)  
**VAUXHALL/OPEL:** Omega-B (01-03)

**Engine:** 2.0; 2.5; 3.0 Diesel

**Engine code:** M47: 20 4D 1; M47TU: 20 4D 4 / M57: 306D1;  
 M57: YD30T2, 204D3TD4 / M57TU: 306D2, 306D5,306D1 / TD6:Y25DT

CODE	€/Pz
FG 192/BW5	190,00

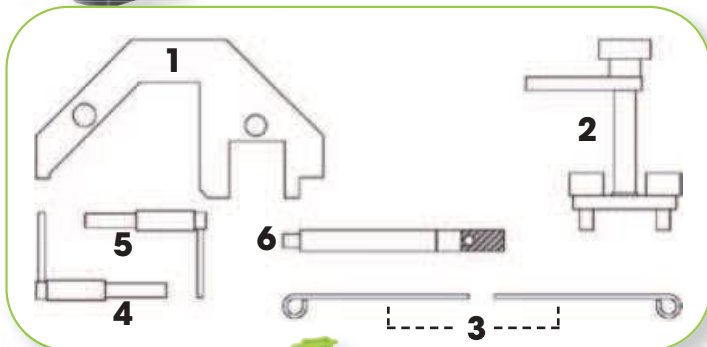

CODE	DESCRIPTION	€/Pz
1: FG 192/BW5-1	Camshaft alignment tool	56,70
2: FG 192/BW5-2	Camshaft locking tool	47,30
3: FG 192/BW5-3	Tensioner locking pins (2 pcs)	9,00
4: FG 192/BW5-4	Flywheel timing pin 1	11,00
5: FG 192/BW5-5	Flywheel timing pin 2	11,00
6: FG 192/BW5-6	Flywheel timing pin	15,80



**Timing tool set for BMW-MINI B38/B48/B58  
1.5, 2.0, 3.0 (Timing chain)**



**Models:**

**BMW:** 116i; 118i; 225xe; 218i; 220i; 225i; 120i; 125i; 320i; 330i; 420i; 430i;  
 530i; 520i; 730i; 740e iPerformance; sDrive 20i; xDrive 25i; 214d; 216d;  
 sDrive 16d; 114d; xDrive25d; 218d; 220d; sDrive 18d; xDrive 18d;  
 xDrive 20d; 316d; 318d; 418d; 420d; 518d; 225d;

**MINI:** Mini Hatch; One D; Convertible; Cooper D; Cooper SD

**Engine:** 1.5, 2.0

**Engine code:** B38 A15A; B38 B15A; B38 K15A; B48 A20B; B48  
 B20A; B48 B20B; B48 A20A; B38 A12A

CODE	€/Pz
FG 192/BW15	850,00

**Camshaft adjuster control valve socket for  
BMW/MINI B38/B48 engines**



CODE	€/Pz
FG 192/BW15A	35,00

**Crankshaft holding tool BMW/MINI N47/N47T/N47S  
(from May 2013 on)**

**Models:**

**BMW:** 123d; 116d; 316d; 118d; 120d; 220d; 118d xDrive; 120d xDrive; 218d; 316d;  
 318d; 420d; 520d; sDrive16d; sDrive18d

**MINI:** Clubvan; Countryman; Mini; Paceman; Roadster; Clubman; Coupe;

**Engine:** 1.6 Diesel; 2.0 Diesel

**Engine code:**

1.6 Diesel: N47 C16U1, N47 C16K1, N47 C16A/U1, N47 D16C, N47 D16  
 2.0 Diesel: N47 C20K1, N47 C20U1, N47 C20A/K1, N47S D20B/D/T0, N47 D20C/K1,  
 N47 D20C, N47 D20C/U1, N47 D20C/O1, N47 D20D, N47 D20D/T1, N47T D20O1, N47  
 D20C/O,N47 D20A, N47 D20C/O1, N47 D20U0



CODE	€/Pz
FG 192/BW4E	96,00





### Timing tool set for BMW N40, N45

**MODEL:**

N40: (E46) 316i/316ti/316Ci  
N45: (E81/E87) 116i; (E90) 316i

**ENGINE:** 1.6

**CODE motore:** N40 B16A; N45TB16AC, N45B16A

CODE	€/Pz
FG 192/BW6	400,00

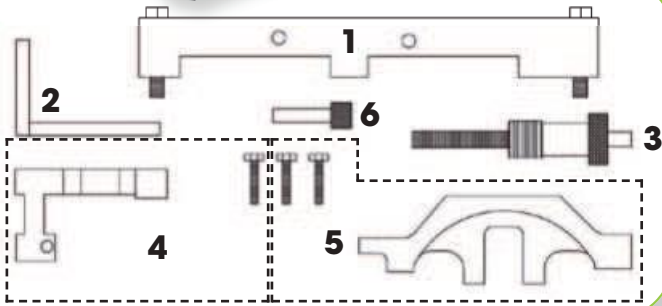

CODE	DESCRIPTION	€/Pz
1: FG 192/BW6-1	Sensor gear alignment tool	159,40
2: FG 192/BW8-2	Flywheel timing pin	16,80
3: FG 192/MI10-4	Timing chain pre-tensioning tool	32,50
4: FG 192/BW6-4	Camshaft alignment tool	153,80
5: FG 192/BW6-5	Camshaft alignment tool	195,80
6: FG 192/BW6-6	Camshaft alignment tool	11,20



### Timing tool set for BMW N42, N46, N46T

**Models:**

N42: (E46) 316i / 316ti / 318ti/318i  
N46: (E87) 118i / 120i; (E90/E91) 318i/320i; Z4 (E85)

**Engine:** 1.8, 2.0

**Engine code:** N42 B18A; N42 B20A  
N46 B18; N46 B20; N46 B20B

CODE	€/Pz
FG 192/BW8	420,00

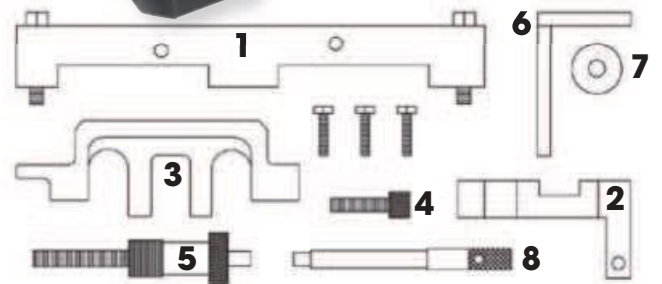

CODE	DESCRIPTION	€/Pz
1: FG 192/BW8-1	Sensor gear alignment tool	119,30
2: FG 192/BW8-2	Inlet camshaft alignment tool	97,60
3: FG 192/BW8-3	Exhaust camshaft alignment tool	135,60
4: FG 192/BW8-4	Camshaft alignment tool	10,80
5: FG 192/MI10-4	Timing chain pre-tensioning tool	32,50
6: FG 192/BW8-6	Flywheel timing pin 2	13,60
7: FG 192/BW8-7	Flywheel timing pin 1	21,70
8: FG 192/BW8-8	Inlet camshaft turning tool	16,30



### Timing tool set for BMW VALVETRONIC

**Models:**

N42: (E46) 316i / 316ti / 318ti/318i  
N46: (E87) 118i / 120i; (E90/E91) 318i/320i; Z4 (E85)

**Engine:** 1.8, 2.0

**Engine code:** N42 B18A; N42 B20A  
N46 B18; N46 B20; N46 B20B

CODE	€/Pz
FG 192/BW18	510,00





**Timing tool set for BMW N62/N73**



**Models:**

**N62:** 540i, 545i, 550i (E60/61); 645i, 650i (E63864), 735i, 740i, 745i 750i (E65/66), X5 (E53/E70)

**N73:** 760i (E65/66)

**Engine:** 3.6-4.0-4.4-4.8

**Engine code:** N62 B40A; N62 B44A; N62 B48B; N62 B36A  
N73 B60A

CODE	€/Pz
FG 192/BW7	<b>350,00</b>

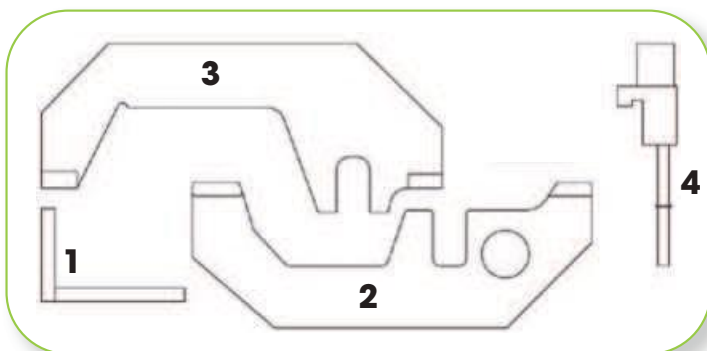

CODE	DESCRIPTION	€/Pz
1: FG 192/BW8-6	Crankshaft pulley alignment tool	<b>13,60</b>
2: FG 192/BW7-2	Inlet camshaft alignment tool	<b>141,00</b>
3: FG 192/BW7-3	Exhaust camshaft alignment tool	<b>141,00</b>
4: FG 192/BW7-4	Camshaft locking tool	<b>55,10</b>



**Timing tool set for BMW N43 1.6 & 2.0**



**Models:**

116i; 118i; 120i; 316i; 318i; 320i; 520i

**Engine:** 1.6; 2.0

**Engine code:** N43 B16A/AA; N43 B16AA; N43 B20K0;  
N43 B20AY; N43 B20A; N43 B20AA;  
N43 B16AA/OO; N43 B20U0

CODE	€/Pz
FG 192/BW9	<b>580,00</b>

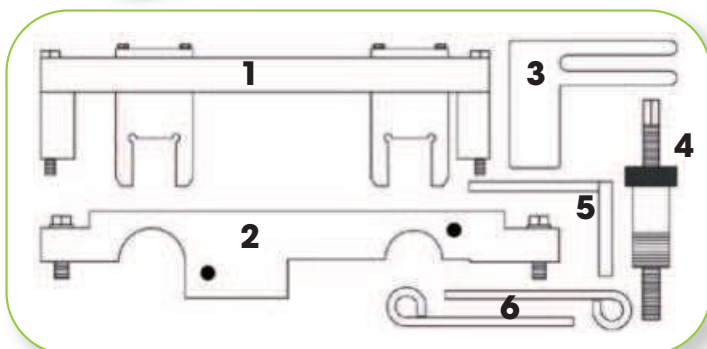

CODE	DESCRIPTION	€/Pz
1: FG 192/BW9-1	Camshaft alignment tool 1, 2, 3	<b>297,50</b>
2: FG 192/BW9-2	Camshaft position (CMP) sensor disc setting tool 1 & 2	<b>158,60</b>
3: FG 192/BW9-3	Balancer shaft alignment tool	<b>35,30</b>
4: FG 192/M110-4	Timing chain pre-tensioning tool	<b>32,50</b>
5: FG 192/BW8-6	Flywheel timing pin	<b>13,60</b>
6: FG 192/BW5-3	Tensioner locking pin (2pcs)	<b>9,00</b>



## Timing tool set for BMW N13 e N18



### Models:

**BMW:** Serie 1 (114i; 116i; 118i); Serie 3 (316i; 320i)

**MINI:** Clubman (Cooper S (R55)); Clubman (JCW (R55)); Countryman (Cooper / Cooper S (R60), JCW (R60)); Coupe (Cooper S / JCW (R58)); Mini (Cooper S (R56/R87); Paceman (Cooper / JCW (R61)); Roadstar (Cooper S/JCW(R59))

**Engine:** 1.6 benzina

**Engine code:** N13, B16A (cambio manuale), N18 B16A; N18 B16M0; N18 B16C; N18 B16A/MO; N18 B16C/TO

CODE	€/Pz
FG 192/BW8B	285,00

CODE	DESCRIPTION	€/Pz
1: FG 192/BW8B-1	Camshaft alignment tool + screws (3 pcs)	170,00
2: FG 192/BW8B-2	Crankshaft timing pin (Manual Transmission)	15,00
3: FG 192/MI10-4	Timing chain pre-tensioning tool	32,50
4: FG 192/MI10-3	Crankshaft timing pin	12,00

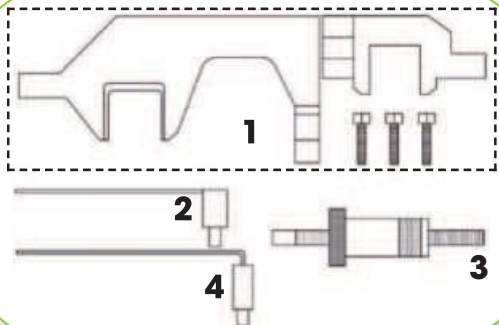

## Timing tool set for BMW N20 e N26



### Models:

Serie 1 (125i); Serie 3 (320i/xDrive; 328i/xDrive);

Serie 5 (520i; 528i/xDrive); X1 (sDrive18i; sDrive20i; xDrive28i);

X3 (xDrive20i; xDrive28i); Z4 (sDrive18i; sDrive20i; sDrive28i)

**Engine:** 2.0 benzina

**Engine code:** N20 B20A; N20 B20B/U0; N20; N26 B20

CODE	€/Pz
FG 192/BW8C	400,00

CODE	DESCRIPTION	€/Pz
1: FG 192/BW8C-1	Camshaft alignment tools	195,00
2: FG 192/BW8C-2	Sensor gear adjusting tool	106,00
3: FG 192/MI10-4	Timing chain pre-tensioning tool	32,50
4: FG 192/BW8C-4	Flywheel/drive plate locking tool	16,00

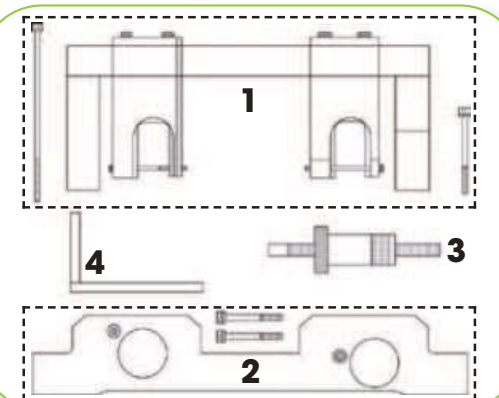



### Timing tool set for ALFA ROMEO 1.4, 1.6, 1.8 2.0



#### Models:

145, 146, 155, 156, 166, 147, GTV, Spider

**Engine:** 1.4, 1.6, 1.8, 2.0 benzina

**Engine code:** 162.01/323.01; 322,01; 335,03; 676,01; 41,03

CODE	€/Pz
FG 192/AF4	170,00

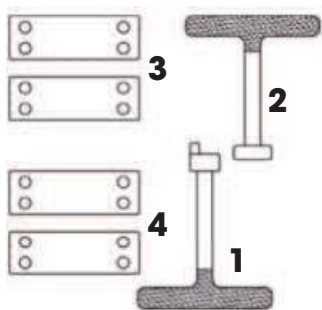

CODE	DESCRIPTION	€/Pz
1: FG 192/AF4-1	Timing belt tensioning tool	19,00
2: FG 192/AF4-2	Balancer shaft belt tensioning tool	20,20
3: FG 192/AF4-3	Camshaft locking tool (purple: 1.4 engines)	59,30
4: FG 192/AF4-4	Camshaft locking tool (blue: 1.8 and 2.0 engines)	59,30



### Timing tool set for ALFA ROMEO 1.75 Tbi



#### Models:

159; BRERA; GIULIETTA; SPIDER. LANCIA: DELTA

**Engine:** 1,75 Tbi; 1,75 DI Turbo

**Engine code:** 939B1.000; 940A1.000

CODE	€/Pz
FG 192/AF4B	260,00



### Timing tool set for ALFA ROMEO 1.6 Eco 105 Hp



**Models:** 147

**Engine:** 1,6 Eco 105 Hp

**Engine code:** 372.03

CODE	€/Pz
FG 192/AF2	60,00



### Timing tool set for ALFA ROMEO 2.0 JTS 165 HP



**Models:** GT, 156

**Engine:** 2.0 JTS

**Engine code:** 932A2.000

CODE	€/Pz
FG 192/AF4C	95,00



### Flywheel locking tool for FIAT

**Models:**

**FIAT:** Punto/Punto Classic; Grande Punto; Punto Evo; Palio Weekend; Stilo; Croma; Idea; Multipla; Strada Pick-Up; Marea; Marea Weekend; Sedici; Doblo'; Doblo' Cargo; Linea; Bravo

**LANCIA:** Lybra; Musa; Delta

**ALFA:** 145; 146; 147; 156; 159

**Engine:** 1.8 petrol

1.6 Multijet, 1.9 JTD - 1.9 Multijet, 2.0, 2.4

CODE	€/Pz
FG 192/FT1	36,00



### Timing tool set for FIAT CROMA, OPEL 2.2 16V



**Models:**

**FIAT:** CROMA

**OPEL:** ASTRA, VECTRA, VX220 SPEEDSTER, ZAFIRA, SIGNUM,

**Engine:** 2.2 16V (petrol with chain)

**Engine code:** 194A1.000; Z22SE; Z22YH

CODE	€/Pz
FG 192/FT3	78,00



### Special tool for holding of water pump for FIAT CROMA, OPEL



**Models:**

**FIAT:** CROMA

**OPEL:** ASTRA, VECTRA, VX220 SPEEDSTER, ZAFIRA, SIGNUM,

**Engine:** 2.2 16V (petrol with chain)

**Engine code:** 194A1.000; Z22SE; Z22YH

CODE	€/Pz
FG 192/FT4	85,00







## Timing tool set for FIAT 1.6 16V



### Models:

Brava; Bravo; Marea; Multipla; Stilo; Palio Weekend

### Engine: 1.6 16V

**Engine code:** 178B3.000; 182A4.000; 182A6.000; 182B6.000

CODE	€/Pz
FG 192/FT5	285,00

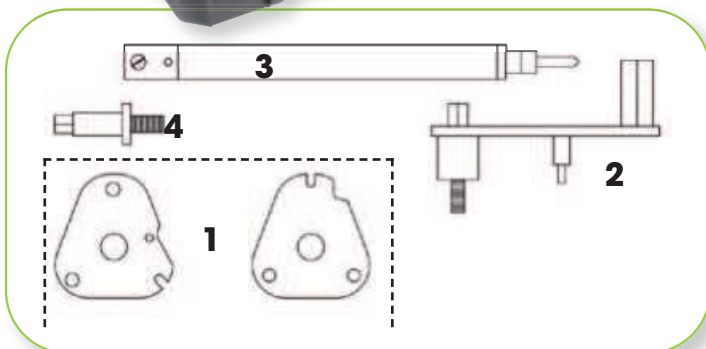

CODE	DESCRIPTION	€/Pz
1: FG 192/FT5-1	Camshaft locking tools	140,00
2: FG 192/FT5-2	Tensioning tool	44,00
3: FG 192/FT5-3	Dial gauge adaptor	41,20
4: FG 192/FT5-4	Flywheel locking tool	9,20

## Flywheel locking tool for FIAT

**Models:** Brava; Bravo; Multipla

**Engine:** 1.6 16V

**Engine code:** 182B6.000, 182A4.000

CODE	€/Pz
FG 192/FT5A	20,00



## Timing tool set for FIAT 1.2/1.4 16V



### Models:

FIAT: Punto, Brava, Bravo, Marea, Stilo, Palio Weekend  
LANCIA: YPSILON, MUSA

### Engine: 1.2 16V, 1.4 16V

**Engine code:** 176B9.000; 182B2.000; 188A5.000; 843A1.000

CODE	€/Pz
FG 192/FT5B	252,00

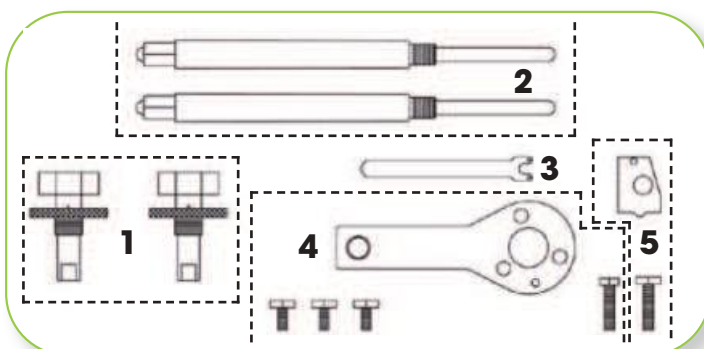

CODE	DESCRIPTION	€/Pz
1: FG 192/FT5B-1	Camshaft locking tools (2 pcs)	70,50
2: FG 192/FT5B-2	Piston position tools (2 pcs)	94,90
3: FG 192/FT12-1	Tensioning tool	9,50
4: FG 192/FT12-3	Crankshaft locking tool	29,00
5: FG 192/FT5B-5	Camshaft sprocket locking tool	33,90



### Timing tool set FIAT, ALFA ROMEO, CHEVROLET, OPEL 1.6, 1.8



**Models:** **FIAT:** Croma; **ALFA ROMEO:** 159;  
**CHEVROLET:** Aveo; Cruze  
**OPEL:** Corsa; Astra, Meriva, Zafira, Vectra, Signum, Insigna  
**Engine:** 1.4, 1.6, 1.8 benzina  
**Engine code:** 939A4.000; G14D; LXV(F16D4); 2HO(Z18XER); Z16LEL; Z16LER; Z16LET; Z16XE1; Z16XEP; Z16XER; A16XER; A18XER; 2HO/A18XEL

CODE	€/Pz
FG 192/FT7	178,00

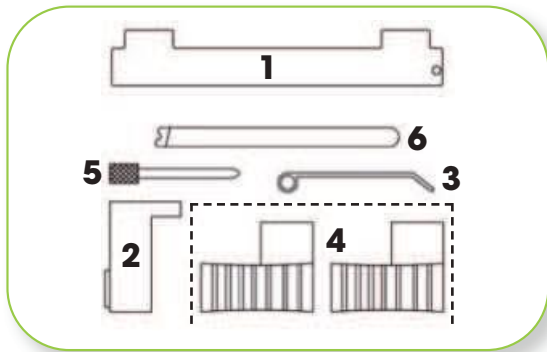

CODE	DESCRIPTION	€/Pz
1: FG 192/FT7-1	Camshafts timing tool	17,80
2: FG 192/FT7-2	Flywheel locking tool	17,80
3: FG 192/FT7-3	Tensioner pulley locking pin	5,10
4: FG 192/FT7-4	Camshaft sprockets locking tool (2 pcs)	91,50
5: FG 192/FT7-5	Auxiliary drive belt tensioner locking tool	10,20
6: FG 192/FT7-6	Flywheel locking tool	7,60



### Timing tool set FIAT 1.2 8V, 1.4 8V



**Models:**  
FIAT 500, Grande Punto, Doblo, Panda EVO2.  
LANCIA Musa

**Engine:** 1.2 8V / 1.4 8V  
**Engine code:** 169A4.000 - 199A4.000 - 350A1.000

CODE	€/Pz
FG 192/FT12	320,00

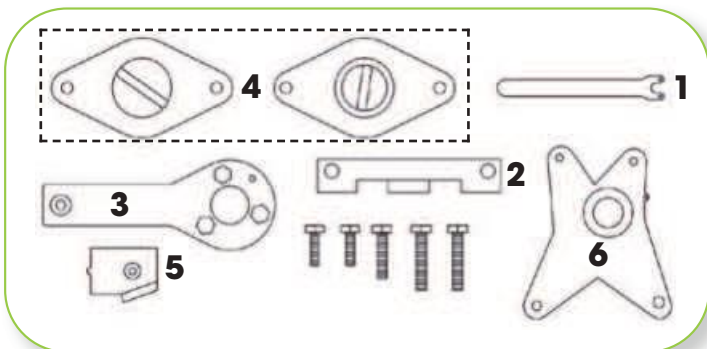

CODE	DESCRIPTION	€/Pz
1: FG 192/FT12-1	Tensioning tool	9,50
2: FG 192/FT12-2	Camshaft locking tool	26,00
3: FG 192/FT12-3	Crankshaft timing tool	29,00
4: FG 192/FT12-4	Camshaft aligning tool	125,00
5: FG 192/FT12-5	Camshaft locking tool	15,00
6: FG 192/FT12-6	Cylinder head cover alignment tool	99,00





### Timing tool set FIAT 1.3 Multijet, 1.3 CDTi, 1.3 DDiS



#### Models:

FIAT: Panda, Punto, Idea, Doblo. LANCIA: Musa, Ypsilon  
OPEL: Agila, Corsa, Combo, Tigra, Meriva, Astra  
SUZUKI: Ignis, Swift

**Engine:** 1.3 Multijet, 1.3 CDTi, 1.3 DDiS

**Engine code:** 188A8.000; 188A9.000; 199A2.000;  
199A3.000; 169A1.000; 223A9.000; Z13DT; Z13 DTH

CODE	€/Pz
FG 192/FT6	245,00

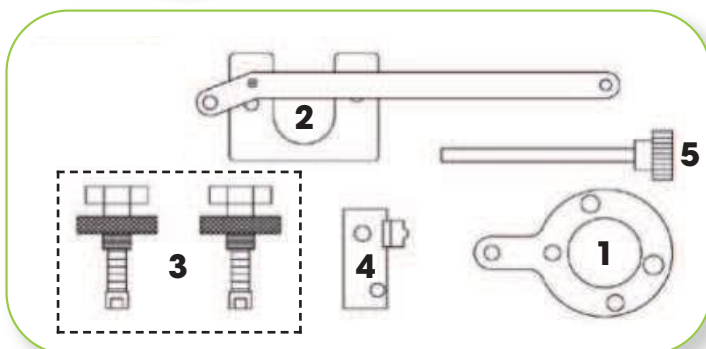

CODE	DESCRIPTION	€/Pz
1: FG 192/FT6-1	Crankshaft timing tool	35,00
2: FG 192/FT6-2	Tensioner Tool	81,40
3: FG 192/FT6-3	Camshaft locking tool (2 pcs)	65,00
4: FG 192/FT6-4	Flywheel locking tool	42,00
5: FG 192/FT6-5	Pin (8 mm)	11,50



### Camshaft locking tools for FIAT 1.3 Multijet, 1.3 CDTi

#### Models:

FIAT: 500/500X, Grande Punto, Punto, Doblò, Panda, Idea  
OPEL: Corsa-E

**Engine:** 1.3 Multijet, 1.3 CDTi

**Engine code:** 188A8.000; 188A9.000; 199A2.000;  
199A3.000; 169A1.000; 223A9.000; LKU/B13DTE;  
LKV/B13DTC; LKU/B13DTR

CODE	€/Pz
FG 192/FT2	55,00



### Attrezzatura bloccaggio mozzo puleggia albero motore e bloccaggio albero a camme per nuovi motori FIAT Multijet



#### Models:

Punto; Grande Punto; Punto Evo; Fiorino; Panda/Panda  
Classic; 500/500C; Doblò; Doblò Cargo; Qubo

**Engine:** 1.3 JTDM; 1.3 JTDM; 1.3 MultiJet 75;

1.3 MultiJet 85; 1.3 MultiJet 90; 1.3 MultiJet 95

**Engine code:** 199A3.000; 199B1.000; 199B4.000;  
169A1.000; 223A9.000; 263A2.000

CODE	€/Pz
FG 192/FT6A	125,00



## Timing tool set FIAT, ALFA ROMEO, LANCIA, OPEL 1.6, 1.9, 2.0, 2.4 JTD Multijet



### Models:

ALFA ROMEO: Mito; Giulietta; 145; 147; 156; 166  
 FIAT: Bravo; Cromia; Grande Punto; Punto EVO; Stilo;  
 Doblo'/Doblo' Cargo; Stilo; Multipla; Marea  
 LANCIA: Delta; Lybra  
 OPEL: Zafira; Vectra; Astra; Insigna  
 SAAB: 9-3

**Engine:** 1.6, 1.9, 2.0, 2.4 JTD

**Engine code:** 192A5.000; 937A5.000; 192B1.000;  
 939A2.000; 250A1.000; 182B9.000; 937A2.000; 937A3.000  
 939B3.000; 955A4.000; Z19DT; Z19DTH; Z19DTJ; Z19DTL;  
 A19DTR

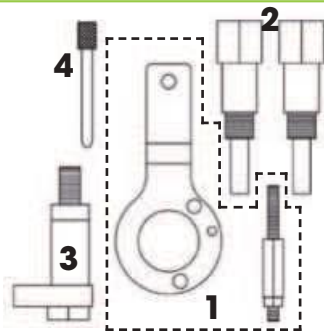

CODE	€/Pz
FG 192/FT6B	158,00

CODE	DESCRIPTION	€/Pz
1: FG 192/FT6B-1	Crankshaft timing tool	42,50
2: FG 192/FT6B-2	Camshaft locking tool (2 pcs)	55,00
3: FG 192/FT17-4	Flywheel locking tool	42,00
4: FG 192/FT6B-4	Pin	6,50



## Timing tool set FIAT 2.3JTD



**Models:** FIAT DUCATO, IVECO DAILY

**Engine:** 2.3D JTD, 2.3D-3.0D Multijet, 2.3D HPI; 3.0 HPI

**Engine code:** F1AE0481C; F1AE0481A; F1AE0481B;  
 F1AE0481H; F1AE0481F; F1AE0481G; F1AE0481R; F1AE0481FA;  
 F1AE0481HA; F1AE0481UA; F1AE0481VA; F1AE0481D; F1A-  
 E0481N; F1AE0481E; F1CE3481N; F1CE3481M; F1CE0481D;  
 F1CE3481E; F1CE3481A; F1CE3481B; F1CE3481H; F1CE3481F

CODE	€/Pz
FG 192/FT5C	130,00

CODE	DESCRIPTION	€/Pz
1: FG 192/FT5C-1	Crankshaft timing pin	36,00
2: FG 192/FT5C-2	Crankshaft timing pin	12,00
3: FG 192/FT5C-3	Camshaft timing pins	45,00
4: FG 192/FT17-12	Camshaft sprocket aligning pin	22,50

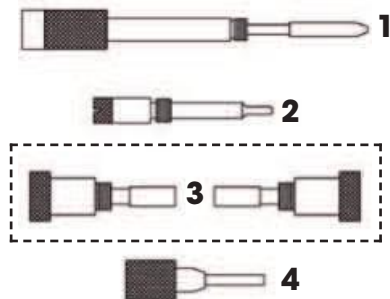

## Timing belt tensioner tool for JTD / MultiJet engines



**Alfa Romeo:** 145, 146, 147, 156, 159, 166, Brera, Giulietta, GT, Mito, Spider  
**Fiat:** 500L, 500X, Brava, Bravo, Cromia, Doblò, Ducato, Freemont, Grande Punto, Idea, Marea, Multipla, Punto, Stilo  
**Lancia:** Delta, Kappa, Lybra, Musa, Thesis  
**Saab:** 9-3, 9-5  
**Suzuki:** SX4

CODE	€/Pz
FG 192/JTD	86,00

**Engine:** 1.6 JTD, 1.9 JTD/JTDM; 2.0 JTD; 2.4 JTD; 1.6 D; 2.0 D; 1.9 D; 1.9 CDTI;  
 2.0 CDTI; 1.9 TiD/TiTD; 2.0 TiD; 2.2 TiTD; 1.9 DDiS





### Timing tool set FIAT TWINAIR

**Models:** 500/500C (07-); Panda (2012)

**Engine:** 900 Twinair Turbo

**Engine code:** 312A2.000



CODE	€/Pz
FG 192/FT6C	125,00

CODE	DESCRIPTION	€/Pz
1: FG 192/FT6C-1	Camshaft locking tool	75,00
2: FG 192/FT6C-2	Crankshaft pulley locking tool	19,50
3: FG 192/FT6C-3	Flywheel/drive plate locking tool	13,00

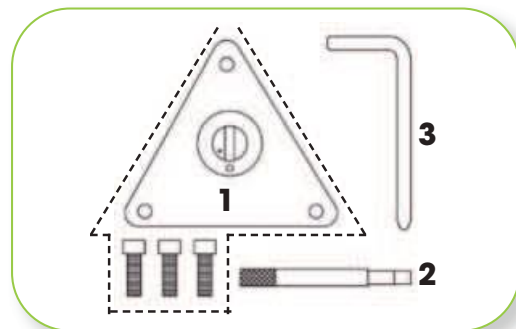

### Balancer shaft alignment tool for Fiat Twinair

**Models:** Ypsilon, 500, 500C, 500L, Punto, Panda, Mito

**Engine:** 900 Twinair, 900 Twinair Turbo Turbo

**Engine code:** 312A5.000, 312A2.000, 199B6.000, 312A7.000

CODE	€/Pz
FG 192/FT6D	78,00



### Timing tool set MULTIAIR

**Models:**

Punto EVO, Punto EVO Abarth, Bravo, 500 Alfa MITO, Giulietta

**Engine:** 1.4 Multicair 16V

**Engine code:** 940A2.000, 955A6.000, 955A2.000, 955A7.000, 955A8.000, 198A7.000



CODE	€/Pz
FG 192/FT10	145,00

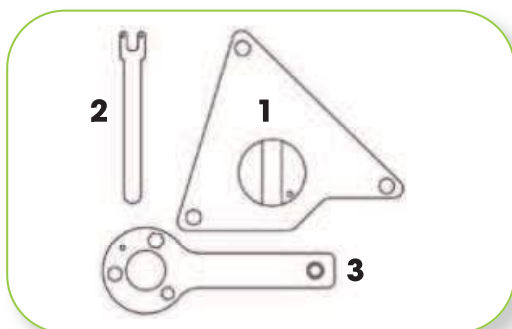

CODE	DESCRIPTION	€/Pz
1: FG 192/FT10-1	Camshaft timing tool	82,00
2: FG 192/FT12-1	Crankshaft locking tool	9,50
3: FG 192/FT10-3	Tensioner pulley adjusting tool	27,00



### Timing tool set FIAT TWINAIR e MULTIAIR

**Models:** 500/500C (07-); Panda (2012), Punto EVO, Punto EVO Abarth, Bravo, 500, Alfa MITO, Giulietta

**Engine:** 900 Twinair Turbo, 1.4 Multiair 16V  
**Engine code:** 312A2.000, 940A2.000, 955A6.000, 955A2.000, 955A7.000, 955A8.000, 198A7.000

CODE	€/Pz
FG 192/FT16	270,00

### Spring compression tool for electro-hydraulic valve control - MULTIAIR and MULTIAIR TURBO

**Models:** Punto EVO, Punto EVO Abarth, Bravo, 500 Alfa MITO, Giulietta, Lancia Delta

**Engine:** 1.4 Multiair 16V  
**Engine code:** 940A2.000, 955A6.000, 955A2.000, 955A7.000, 955A8.000, 198A7.000

CODE	€/Pz
FG 192/FT10C	370,00



### Timing tool set FIAT, IVECO, FORD, PEUGEOT, CITROEN

**Models:** FIAT: Ducato, IVECO: Daily, CITROEN: Relay/Jumper III  
PEUGEOT: Boxer III, FORD: Transit Van

**Engine:** 2.2 - 2.3 - 3.0 JTD MJ (catena o cinghia)  
**Engine code:** 4HU(P22DTE); 4HV(P22DTE); P8FA; P8FB; QVFA; QWFA; SRFA; SRFB; SRFC; SRFD; SRFE; PGFA; PGFB; F1AE0481A/B/C/D/E/F/FA/G/H/HA/N/R/UA/VA F1CE3481/A/B/E/F/H/M

CODE	€/Pz
FG 192/FT17	650,00

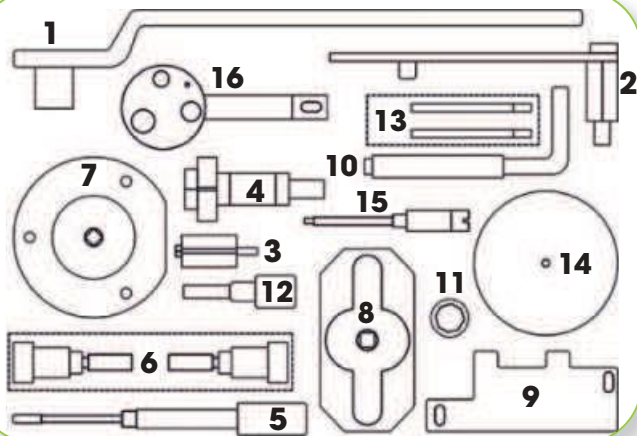

CODE	DESCRIPTION	€/Pz
1: FG 192/FT17-1	Crankshaft holding/turning tool (2.2 MJ)	95,00
2: FG 192/FT17-2	Crankshaft alignment tool (2.2 MJ)	56,00
3: FG 192/FT17-3	Flywheel Locking Tool (2.3 MJ)	32,00
4: FG 192/FT17-4	Flywheel Locking Tool (3.0 MJ)	42,00
5: FG 192/FT17-5	Crankshaft timing pin (2.3 - 3.0 MJ)	29,50
6: FG 192/FT17-6	Camshaft timing pins (2x) (2.3 - 3.0 MJ)	36,50
7: FG 192/FT17-7	Extract/introduce tool for oil case (distribution) (2.2 MJ)	67,00
8: FG 192/FT17-8	Crankshaft holding/turning tool (3.0 MJ)	67,00
9: FG 192/FT17-9	Setting plate (Oil Pump) (2.2 MJ)	12,50
10: FG 192/FT17-10	Crankshaft position (CKP) sensor alignment tool (2.2 MJ)	18,00
11: FG 192/FT17-11	Water sensor instalSideon socket (2.2 MJ)	12,50
12: FG 192/FT17-12	Camshaft sprocket aligning pin (2.3 MJ)	22,50
13: FG 192/FT17-13	Camshaft sprocket timing pin (2x) (2.2 MJ)	29,50
14: FG 192/FT17-14	Timing cover centring plate (2.2 MJ)	77,00
15: FG 192/FT17-15	Crankshaft timing pin (2.3 MJ)	10,00
16: FG 192/FT17-16	Crankshaft timing tool (2.2 MJ)	40,00





### Timing tool set for FORD 1.0 ECOBOOST

**Engine:** B-MAX; Fiesta; C-MAX; Grand C-MAX; Focus; EcoSport;

**Engine:** 1.0 EcoBoost; 1.0 SCTi EcoBoost

**Engine code:** SFJA; SFJB; M1DA; M2DA; M1JC;  
M1JE; P4JA; P4JB

CODE	€/Pz
FG 192/FO16	660,00



### Crankshaft pulley bolt removal/installation tool FORD 1.0 EcoBoost

**Engine:** B-MAX; Fiesta; C-MAX; Grand C-MAX; Focus; EcoSport;

**Engine:** 1.0 EcoBoost; 1.0 SCTi EcoBoost

**Engine code:** SFJA; SFJB; M1DA; M2DA; M1JC;  
M1JE; P4JA; P4JB



CODE	€/Pz
FG 192/FO16A	1.250,0



### Timing tool set for FORD 2.0 ECOBOOST

**Engine:** Focus, Mondeo, Galaxy, S-Max

**Engine:** 2,0 Ti-VCT; 2,0 SCTi EcoBoost; 2,0 EcoBoost

**Engine code:** MGDA; TNBA; TNBB; TNWA; TNWB; TPBA;  
TPWA; XQDA; R9CB; R9CF; R9CH; TNCC; TNCD; TNCF

CODE	€/Pz
FG 192/FO16B	210,00



### Timing tool set for FORD 1.4/1.6 TDCi, VOLVO 1.6/2.0, CITROËN 1.6/2.0/2.2 HDi, FIAT 1.6/2.0/2.2 Multijet

**Ford:** C-MAX, Fiesta, Focus, Focus, Focus C-MAX

**CITROËN:** Dispatch/Jumpy III, C4, C4 Picasso/Grand Picasso, C5 II, C5 III, C6, C8

**FIAT:** Scudo

**VOLVO:** C30, C70, S40, S80, V50, V70

**Engine codes:**

-G8DA, G8DB, G8DC, G8DD, G8DE, G8DF, H8DA, H8DB, F6JA, F6JB, F6JC, H8JA, H8JB, H8JC, H8JD, H8JE, H8JF

-9HU (DV6UTED4), 4HP (DW12BTED4), 4HR (DW12BTED4), 4HS (DW12BTED4), 4HT

(DW12BTED4), RHK (DW10UTED4), RHR (DW10BTED4)

-9H07, 9HU (DV6UTED4), RHK (DW10UTED4), RHR (DW10BTED4)

-D4164T, D4164T DRIVE, D4204T, D4204T2

**Engine:** 1.4, 1.6 TDCi / 1.6 HDi, 2.0 HDi, 2.2 HDi / 1.6, 2.0, 2.2 Multijet / 1.6, 2.0



CODE	€/Pz
FG 192/FO6	102,00



### Balancer shaft locking set for FORD, LAND ROVER 2.2 D

**Models:**

**FORD:** Galaxy, S-Max, Mondeo

**LAND ROVER:** Freelander 2; Range Rover Evoque; Discovery Sport

**Engine:** 2.2

**Engine code:** KNWA; Q4BA; Q4WA; DW12CTED4; 224DT

CODE	€/Pz
FG 192/FO7C	110,00





## Timing tool set FORD 1.25/1.4/1.6/1.6 Ti-VCT (petrol), 2.0 TDCI

### Models:

FORD: C-Max; Gran C-Max; Focus; Fiesta; Mondeo;  
Kuga; Galaxy; Fusion; S-Max  
VOLVO: S60; S80; V70

**Engine:** 1.6 / 1.6 Ti-VCT (benzina); 2.0 TDCI

**Engine code:** HXDA; HXDB; SIDA; IQDA; IQDB; PNDA; XTDA; U5JA;  
RHBA; G6DA; G6DB; G6DC; G6DD; G6DE; G6DF; IXDA; TXDA; TXDB;  
TYDA; UKDA; UKDB; UFWA; F8JA; F8JB; FUJA; FUJB; M7JA; M7JB; SNJA;  
SNJB; STJA; STJB; ASDA; ASDB; FXJA; FXJB; FXJC; SPJA; SPJC; SPJD; FYJA;  
FYJB; FYJC; HWDA; HWDB; SHDA; SHDB; SHDC; JQDA; JQMA; JQMB;  
JTMA; IQJA; JQDA; JTWA; JTWB; KGBA; B4164T; B4164T3; B4164T2

CODE	€/Pz
FG 192/FO4	185,00



CODE	DESCRIPTION	€/Pz
1: FG 192/VW7-5	Tensioner locking pin	7,10
2: FG 192/FO4-2	Tensioner locking pin	16,50
3: FG 192/FO4-3	Camshaft sprocket locking tool	78,00
4: FG 192/FO4-4	Flywheel timing pin	12,00
5: FG 192/FO4-5	Camshaft sprocket locking tool	8,50
6: FG 192/FO24-4	Camshaft setting bar	12,00
7: FG 192/FO4-7	Crankshaft pulley alignment tool	22,00

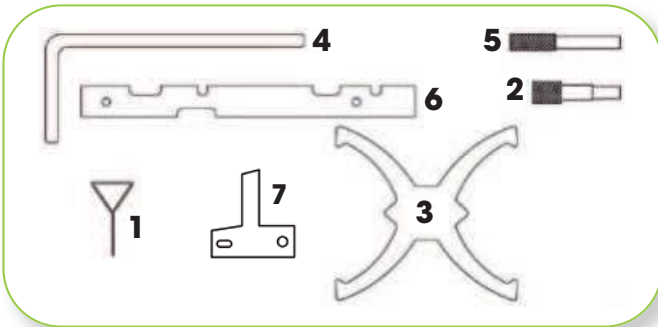

## Camshaft setting bar - FORD 1.6 ECOBOOST

### Models:

B-Max; C-Max; Fiesta; Focus; Galaxy; Gran C-Max; Kuga;  
Mondeo; S-Max; Tourneo Connect; Transit Connect

**Engine:** 1.6 ECOBOOST

**Engine code:** JQMA; JQMB; JTMA;

IQJA; JQDA; IQDA; JTWA; JTWB; KGBA



CODE	€/Pz
FG 192/FO4A	80,00

## Timing tool set FORD 2.0 EcoBlue Diesel TDCi

### Models:

Transit; Transit Custom; Tourneo Custom

### Engine:

2.0 EcoBlue TDCi (dal 2016 in poi)

### Engine codes:

YLFS; YLF6; YLR6; YMF6; YMFS; YMR6; YNF6; YNFS; YNR6

CODE	€/Pz
FG 192/FO15	550,00



## Injection pump remover/installers for FORD 2.0 EcoBlue Diesel TDCi

### Models:

Transit; Transit Custom; Tourneo Custom

### Engine:

2.0 EcoBlue TDCi (from 2016 on)

### Engine codes:

YLFS; YLF6; YLR6; YMF6; YMFS; YMR6; YNF6; YNFS; YNR6



CODE	€/Pz
FG 192/FO15A	250,00







### Timing tool set FORD Transit 2.2 TDCI

**Models:** Ford Transit

**Engine:** 2.2 TDCI

**Motor code:** CYFA; CYFB; DRFA; USR6; SRFA; SRFB; SRFC; SRFD; SRFE; UHFA; QVFA; QWFA; PGFA; PGFB



CODE	€/Pz
FG 192/FO7	95,00

CODE	DESCRIPTION	€/Pz
1: FG 192/PS15-8	Camshaft timing pins (6mm)	15,00
2: FG 192/FO24-20	Crankshaft alignment pin	12,50
3: FG 192/FO7-3	Crankshaft sprocket locking tool	52,50

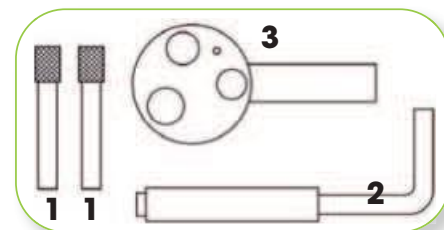

### Crankshaft holding tool for FORD Transit 2.2 TDCII

CODE	€/Pz
FG 192/FO7B	105,00



### Crankshaft locking tool FORD 2.2 TDCI

**CODE motore:**

CYRA; CVRA; CVRB; DRRR; DRRB; USRA; USRB

CODE	€/Pz
FG 192/FO7E	35,00



### Timing tool set FORD/MAZDA

**Models:**

**FORD:** C-Max; Courier; Fiesta; Focus; Focus C-Max; Galaxy; Grand C-Max; S-Max; Mondeo; Tourneo; Transit

**MAZDA:** 121

**Engine:**

1.25, 1.4, 1.6, 1.8, 2.0, 2.9, 1.4D, 1.6D, 1.8D, 1.9D, 2.0D, 1.8D Turbo, 1.8 XR2i, 1.8 TDDi, 1.8D TDCi, 1.4D TDCi, 1.6 TDCi, 1.9 TDI, 1.9D TDI PD, 2.0D TDCi, 2.0 SR150, 2.5 DI/Turbo/TCI

**Engine code:**

BHPA; KKDA; HCPA; TZJA; T1DA; C9DC; RTN/RTQ; RTP; DHA; C9DC; UBJA; C9DA/B; FFDA; F9DA/B; BHDA/B; QYWA; FFWA; ANU; UBJA; CFBA; R3PA; HCPA; HCPB; R2PA; P9PA; P7PA; R3PA; RWPA; RWPC; BHPA; 4CA; 4CB; 4FD; 4AB; 4BB; 4BA; 4AE; 4GA; DHA

CODE	€/Pz
FG 192/FO24	280,00

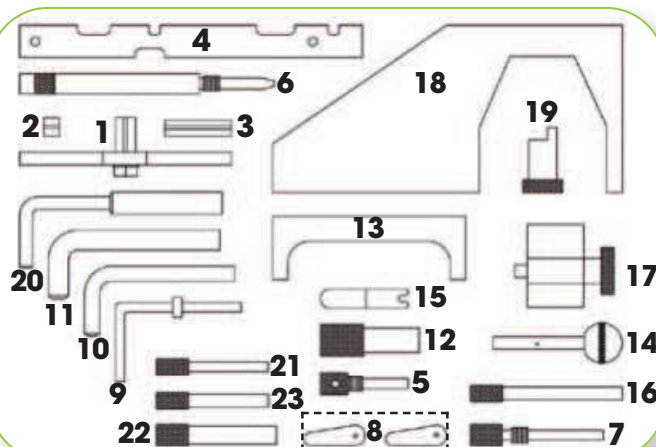

CODE	DESCRIPTION	€/Pz
1: FG 192/FO24-1	Flywheel locking tool	41,90
2: FG 192/FO24-2	Adaptor for flywheel locking tool	9,70
3: FG 192/FO24-3	Adaptor for flywheel locking tool	12,90
4: FG 192/FO24-4	Camshaft locking bar	12,00
5: FG 192/FO24-5	Crankshaft timing pin (65x7,5mm)	13,00
6: FG 192/FO24-6	Crankshaft timing pin	17,50
7: FG 192/FO24-7	Crankshaft timing pin (Ø6mm)	8,30
8: FG 192/FO24-8	Thickness	12,90
9: FG 192/FO24-9	Camshaft timing pin (Ø12,7mm)	12,50
10: FG 192/FO24-10	Camshaft timing pin	6,20
11: FG 192/FO24-11	Flywheel timing pin	6,20
12: FG 192/FO24-12	Locking pin for gear of Injection pump	8,10
13: FG 192/FO24-13	Camshaft locking bar	8,10
14: FG 192/FO24-14	Injection pump locking pin	14,20
15: FG 192/FO24-15	Two pins wrench	3,20
16: FG 192/FO24-16	Pin	6,40
17: FG 192/FO24-17	Locking pin for gear of crankshaft	29,00
18: FG 192/FO24-18	Camshaft alignment tool	22,50
19: FG 192/FO24-19	Crankshaft tool	19,30
19: FG 192/FO24-20	Flywheel locking tool	12,50
20: FG 192/FO24-21	Crankshaft alignment tool	12,00
21: FG 192/FO24-22	Flywheel locking tool	4,80
22: FG 192/FO24-23	Camshaft locking tool	15,00

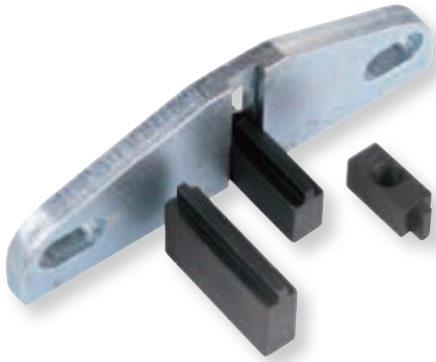

## Flywheel locking tool for FORD

Diesel, Petrol - Belt and Chain

CODE	€/Pz
FG 192/FO3	52,00



## Timing tool set FORD ZETEC and DURATEC

**Models:**

**FORD:** Fiesta, Fusion, Courier, Escort, Focu, Puma, Mondeo, Transit, Connect, CougarOrion, Kombi, Galaxy

**MAZDA:** 121 benzina

**VOLVO:** S40, V50 benzina

**Engine:** 1.2,2.4,1.6,1.6 16V, 1.7 16 cinghia, 1.8D, 1.8TD, 1.8 e 2.0 16V cinghia e catena

**Motor code:** DHA, DHB, DHC, DHD, DHE, DHE, DHG, FHA, FHE, 4HA

CODE	€/Pz
FG 192/FO8	95,00

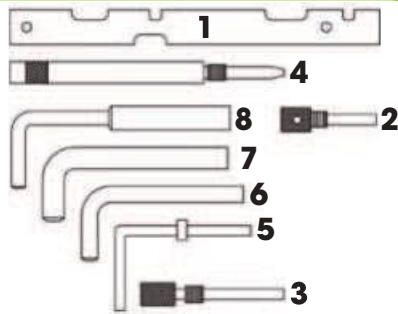

CODE	DESCRIPTION	€/Pz
1: FG 192/FO24-4	Camshaft locking bar	12,00
2: FG 192/FO24-5	Cranckshaft timing pin (40x5mm)	13,00
3: FG 192/FO24-7	Cranckshaft timing pin (65x7,5mm)	8,30
4: FG 192/FO24-6	Cranckshaft timing pin	17,50
5: FG 192/FO24-9	Camshaft timing pin (Ø6mm)	12,50
6: FG 192/FO24-10	Camshaft timing pin (Ø9,5mm)	6,20
7: FG 192/FO24-11	Camshaft timing pin (Ø12,7mm)	6,20
8: FG 192/FO24-20	Flywheel locking tool	12,50



## Timing tool set FORD 2.0,2.2, 2.4, DURATORQ 16V

**Models:**

Mondeo, Transit, Focus

**Engine:** 2.0, 2.2 & 2.4 DURATORQ 16V

**Engine code:** FMBA/B, HJBA, HJBB, HJBC, HJBE, SDBA, D5BA, D6BA, QJBA, QJBB, QJBC, ABFA, D3FA, F3FA, FIFA, D2FA, D4FA, DOFA, F4FA, FXFA, H9FA

CODE	€/Pz
FG 192/FO11	248,00

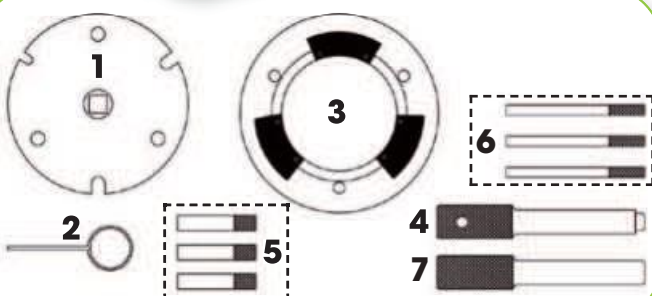

CODE	DESCRIPTION	€/Pz
1: FG 192/FO11-1	Plate for disassembly / assembly of fuel pump cover	77,10
2: FG 192/FO11-2	Tensioner pin ø 1.9	3,00
3: FG 192/FO11-3	Locking plate for gear of Injection Fuel pump	83,10
4: FG 192/FO11-4	Flywheel locking pin ø 14 ø 10	23,70
5: FG 192/FO11-5	Fuel pump locking Pins	17,80
6: FG 192/FO11-6	Sprockets camshafts locking pins ø 6	17,80
7: FG 192/FO11-7	Flywheel locking pin ø 14	23,70





## Set fasatura motori JAGUAR e LAND ROVER 2.0 INGENIUM DIESEL

### MODEL:

**JAGUAR:** E-Pace (X540) D150/D180/D240; F-Pace (X761) 20d/25d/E-Performance, XE(X760) 20d/25d/E-Performance, XF(X260)  
**LAND ROVER:** Discovery Sd4/Td4, Discovery Sport Td4/Sd4, Range Rover Evoque eD4/TD4/Sd4, Range Rover Evoque Convertible eD4/Td4/Sd4, Range Rover Velar D180/D240

**ENGINE:** 2.0 D

**CODE motore:** 204DT, 204DTA, AJ-200D/204DT, AJ-200D, 204DTD

CODE	€/Pz
FG 192/LR11	820,00



## Timing tool set JAGUAR e LAND ROVER 3.2, 3.5, 4.0, 4.2, 4.4 V8

### Models:

**JAGUAR:** XJ8, XJ8 Sport, Sovereign, XJR V8, XKR, S-Type, XK8  
**LAND ROVER:** Range Rover Supercharged, Discovery 3, Range Rover

**DAIMLER:** V8, Super V8

**Engine:** 3.2, 3.5, 4.0, 4.2

**Engine code:** AC, KB, KC, RB, BC, CC, CE, LB, LC, MA, MB, NB, NC, 1B, 2B, 3B, 1G, 5G, 9G, HB, HG, SB, TB, PC, 428PS, 448PN, BC, DC

CODE	€/Pz
FG 192/LR9	370,00



## Timing tool set JAGUAR e LAND ROVER 2.0 GTDI

### Models:

**JAGUAR:** XE, XJ, XF  
**LAND ROVER:** Discovery Sport, Freelander 2  
**RANGE ROVER:** Evoque

**Engine:** 2.0 GTDI

**Engine code:** 204PT

CODE	€/Pz
FG 192/LR8	315,00



## Crankshaft pulley removal/installation set for JAGUAR & LAND ROVER V8

### Models:

**JAGUAR:** XJ8; XJ8 Sport; Sovereign; XJR V8; XKR; S-Type; XK8  
**LAND ROVER:** Range Rover Supercharged; Discovery 3; Range Rover

**Engine:** 3.2; 3.5; 4.0; 4.2

**Engine code:** AC, KB, KC, RB, BC, CC, CE, LB, LC, MA, MB, NB, NC, 1B, 2B, 3B, 1G, 5G, 9G, HB, HG, SB, TB, PC, 428PS, 448PN, BC, DC

CODE	€/Pz
FG 192/LR6	275,00



## Timing tool set Land Rover TD5

**Models:** LAND ROVER: Defender, Discovery II

**Engine:** 2.5 Diesel

**Engine code:** 10P, 15P, 16P

CODE	€/Pz
FG 192/LR2	55,00





### Timing tool set BMW Mini One, Cooper, Cooper S 1.6 (R50/R52/R53)

**Models:**

Mini Cooper 2001-09; Mini Cooper S 2002-2004;  
Mini One 2001-2009

**Engine:** 1.6 benzina

**Engine code:** W10B16BA; W11B16AA; W10B16AA

CODE	€/Pz
FG 192/MI6	210,00

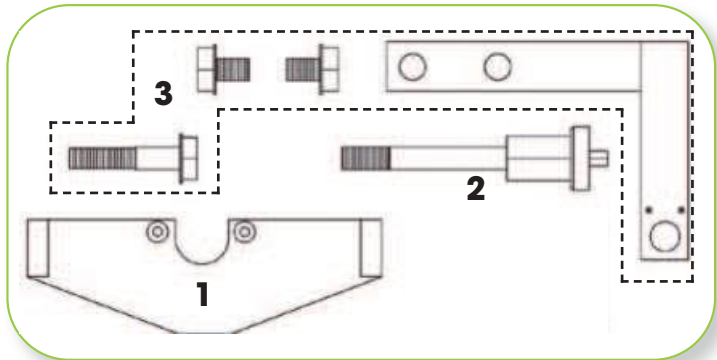

CODE	DESCRIPTION	€/Pz
1: FG 192/MI6-1	Camshaft sprocket holding tool	70,20
2: FG 192/MI6-2	Engine support bracket	39,00
3: FG 192/MI6-3	Tensioner assembly tool	101,40



### Timing tool set for MINI, PSA 1.4, 1.6 VTI

CODE	€/Pz
FG 192/MI10B	320,00

**Models:**

*Mini:* Clubman

*Citroen:* C3 III; C4 II; DS3/DS3 Cabrio; Berlingo III; C3 Picasso;  
C4 Picasso/Grand Picasso II; C5 III (2010 - 2013); DS4

*Peugeot:* 308; 207; 208; 3008; 308; 308 CC; 5008; 508; Partner III

**Engine:** 1.4 VTI, 1.6 VTI

**Engine code:** 8FR(EP3C); 5FS (EP6C); 5FW (EP6);  
EP3C (8FR); EP6C (5FS); EP3 (8FS)

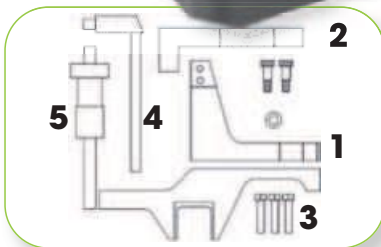

CODE	DESCRIPTION	€/Pz
1: FG 192/MI10B-1	Inlet camshaft locking tool	185,00
2: FG 192/MI10B-2	Exhaust camshaft locking tool	110,00
3: FG 192/MI10B-3	Screw	8,50
4: FG 192/MI10B-4	Flywheel locking tools	30,00
5: FG 192/MI10-4	Crankshaft timing pin	32,50



### Timing tool set for MINI, PSA 1.4, 1.6 16V N12&N14



**Models:**

*Mini:* Mini One, Mini Couper, Mini Couper S, Mini Clubman

*Citroen:* C4, C4 Picasso

*Peugeot:* 207, 308

**Engine:** 1.4 (N12/N14), 1.6 THP

**Engine code:** R55, R56, EP3, EP6, EP6DT, DTS

CODE	€/Pz
FG 192/MI10	365,00

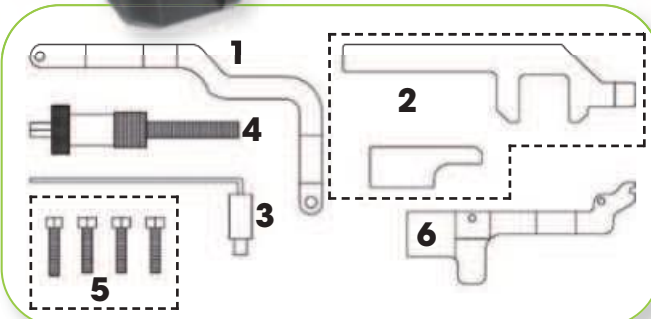

CODE	DESCRIPTION	€/Pz
1: FG 192/MI10-1	Inlet camshaft alignment tool (N12)	98,00
2: FG 192/MI10-2	Inlet camshaft alignment tool (N14)	110,00
3: FG 192/MI10-3	Crankshaft timing pin	12,00
4: FG 192/MI10-4	Timing chain pre-tensioning tool	32,50
5: FG 192/MI10-5	Screw	3,10
6: FG 192/MI10-6	Exhaust camshaft alignment tool (N12&N14 motors)	95,00





### Timing tool set motori MW MINI 1.6 W16D

#### Models:

MINI: Clubman (Cooper D) (R55), Cooper D (R56/57), One D (R56/57)

CITROEN: Berlingo III, Berlingo/Berlingo First I/II, C2, C3 I/II/First/Classic, C3 Picasso, C4, C4 Picasso/Grand Picasso, C5 II, C5 III, Xsara Picasso, C4 Aircross, C4 II, DS3/DS3 Cabrio, DS4, DS5, Dispatch/Jumpy III

PEUGEOT: 1007, 206, 206 CC, 207, 207 CC, 3008, 307, 308, 308 CC, 407, 5008, Partner III, Partner/Partner Origin/Ranch I/II, Expert III

**Engine:** 1.6 D, 1.6 Hdi, 1.6 e-HDi Airdream, 1.6 e-Hdi

**Engine code:** W16 D16 (9HZ), W16 D16U0

CODE	€/Pz
FG 192/MI9	78,00



### Timing tool set for 1.8/2.1 MERCEDES-BENZ CDI Diesel -M651 from 2012

#### Models:

Classe A, Classe B, Classe C, Classe E, CLS, Sprinter, Viano, Vito

**Engine:** 1.8 CDI, 2.1 CDI

**Engine code:** M651 dal 2012 in poi

CODE	€/Pz
FG 192/MB3C	256,00



### Timing tool set for 1.8/2.1 MERCEDES-BENZ CDI Diesel -M651

#### Models:

Classe-A, Classe-B, Classe-C, Classe-C Coupe, CLA, CLS, Classe E, Classe E, Coupe/Cabriolet, GLK, Classe-M, Classe-S, SLK, Sprinter, Viano, Vito

**Engine:** 1.8 CDI, 2.1 CDI

**CODE motore:** 651.901, 651.910, 651.911, 651.912, 651.913, 651.916, 651.922, 651.924, 651.925, 651.930, 651.940, 651.955, 651.956, 651.957, 651.960, 651.961, 651.980

CODE	€/Pz
FG 192/MB3	235,00

### Balance shaft locking tool for MERCEDES-BENZ 1.8/2.1 CDI Diesel (M651)

#### Models:

Classe-A, Classe-B, Classe-C, Classe-C Coupe, CLA, CLS, Classe E, Classe E, Coupe/Cabriolet, GLK, Classe-M, Classe-S, SLK, Sprinter, Viano, Vito

**Engine:** 1.8 CDI, 2.1 CDI

**CODE motore:** 651.901, 651.910, 651.911, 651.912, 651.913, 651.916, 651.922, 651.924, 651.925, 651.930, 651.940, 651.955, 651.956, 651.957, 651.960, 651.961, 651.980

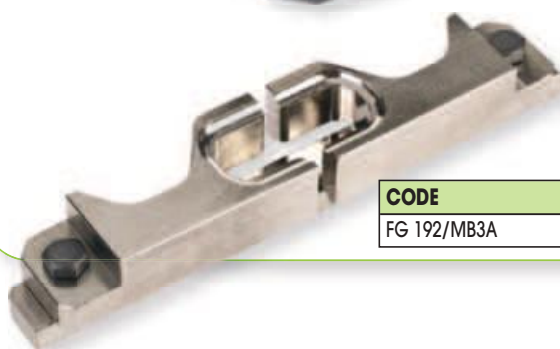

CODE	€/Pz
FG 192/MB3A	205,00



## Camshaft clamping tools - MERCEDES-BENZ 1.6 / 2.0 petrol engines

### Models:

Classe A, Classe B, CLA, Classe C, Classe C Coupe, Classe E, GLK

**Engine:** 1.6, 2.0 Benzina

**Engine code:** 270.910, 270.920, 133.980, 274.910, 274.920

CODE	€/Pz
FG 192/MB24	820,00

CODE	DESCRIPTION	€/Pz
1: FG 192/MB24-1	Gruppo bloccaggio albero a camme (estremità catena) (dal 2009 al 2014)	220,00
2: FG 192/MB24-2	Gruppo bloccaggio albero a camme (estremità catena) (dal 2014 -)	150,00
3: FG 192/MB24-3	Gruppo bloccaggio albero a camme (estremità scatola del cambio)	250,00
4: FG 192/MB24-4	Blocchi per albero a camme di diametro ridotto	60,00
5: FG 192/MB24-5	Viti per gruppo di bloccaggio albero a camme	8,00
6: FG 192/MB24-6	Chiave a bussola di sicurezza	15,00

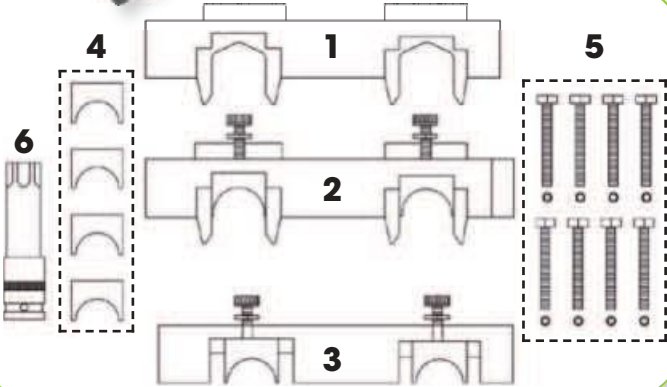

## Timing tool set for Mercedes-Benz 1.8

### Models:

Classe-C; Classe C Coupe; Classe CLC; CLK;  
Classe E; SLK; Sprinter

**Engine:** 1.8 Benzina

**Engine code:** 271.820; 271.860; 271.861; 271.921; 271.940;  
271.941; 271.942; 271.944; 271.946; 271.948; 271.950; 271.951;  
271.952; 271.954; 271.955; 271.956; 271.957; 271.958

CODE	€/Pz
FG 192/MB5	360,00

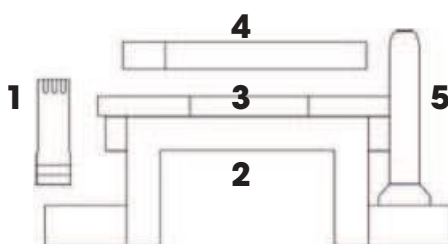

CODE	DESCRIPTION	€/Pz
1: FG 192/MB5-1	Socket wrench	19,00
2: FG 192/MB5-2	Timing chain to camshaft sprocket holder	129,00
3: FG 192/MB5-3	Camshaft holding tool	118,00
4: FG 192/MB5-4	Tensioner rail wedge	38,00
5: FG 192/MB5-5	Chain tensioner drift	29,00



## Timing tool set for MERCEDES-BENZ M642

### Models:

Classe C; CLK; CLS; CLASSE E; CLASSE GL; GLK;  
CLASSE M; CLASSE R; CLASSE S; SPINTER; VITO; VIANO

**Engine:** 3.0 Diesel

**Engine code:** M642 (642,82; 642,822; 642,83; 642,835;  
642,836; 642,838; 642,992; ...)

CODE	€/Pz
FG 192/MB10	160,00





### Timing tool set for 2.1, 2.2, 2.7, 3.2 CDI/CRD Mercedes-Benz e Chrysler

CODE	€/Pz
FG 192/MB6	175,00

#### Models:

*Mercedes-Benz:* Classe-C; Classe-CLC; CLK; Classe-E; Viano; Vito; Sprinter; Classe-M; Classe-S

*Chrysler:* PT Cruiser

**Engine:** 2.1 CDI; 2.2 CDI; 2.7 CDI; 3.2 CDI; 2.2 CRD

**Engine code:** 611.960; 611.961; 611.962; 611.987; 611.980; 611.981; 612.961; 612.962; 612.963; 612.965; 612.967; 613.960; 613.961; 646.811; 646.812; 646.820; 646.821; 646.951; 646.961; 646.962; 646.963; 646.980; 646.981; 646.982; 646.984; 646.985; 646.986; 646.989; 646.990; 647.961; 648.961; 648.960; EDJ

CODE	DESCRIPTION	€/Pz
1: FG 192/MB6-1	Flywheel/drive plate locking tool with M6x90 mm bolts	56,00
2: FG 192/MB6-2	Flywheel/drive plate locking tool (starter motor aperture)	73,00
3: FG 192/MB6-3	Camshaft timing pins (2 pieces)	35,00

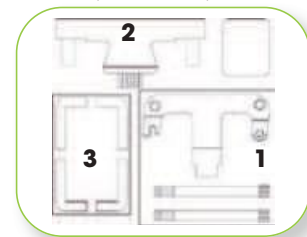

### Timing tool set for CHRYSLER, JEEP, DODGE

#### Models:

*CHRYSLER:* Grand Voyager

*JEEP:* Cherokee, Wrangler

*DODGE:* Nitro

**Engine:** 2.8 Diesel

**Engine code:** VM64C, ENS, ENS (51C), 49C, 50C, ENS VM10D

CODE	€/Pz
FG 192/CH3	145,00



### Timing tool set for JEEP and CHRYSLER 2.5 CRD / 2.8 CRD

#### Models:

*JEEP:* Cherokee. LDV: Maxus

*CHRYSLER:* Grand Voyager, Voyager.

**Engine:** 2.5CRD, 2.8CRD

**Engine code:** R2516C, R2816C5.05A, R2516K, R2816K4, R2516L VM39/40B, R2516L7 VM57/58C

CODE	€/Pz
FG 192/CH8	220,00

CODE	DESCRIPTION	€/Pz
1: FG 192/CH8-1	Inlet camshaft locking pin	34,40
2: FG 192/CH8-2	Exhaust camshaft locking pin	24,60
3: FG 192/CH8-3	Flywheel locking pin (Voyager/Grand Voyager 2.5/2.8 and LVD Maxus)	29,50
4: FG 192/CH8-4	Flywheel locking pin (Jeep Cherokee 2.8)	27,00
5: FG 192/CH8-5	Flywheel locking pin (Jeep Cherokee 2.5)	27,00
9: FG 192/VW1D	Tensioner pulley tool	26,00
10: FG 192/CH8-7	Balancer shaft locking pin	14,70
11: FG 192/CH8-8	Flywheel locking pin (Balancer Shaft)	29,50

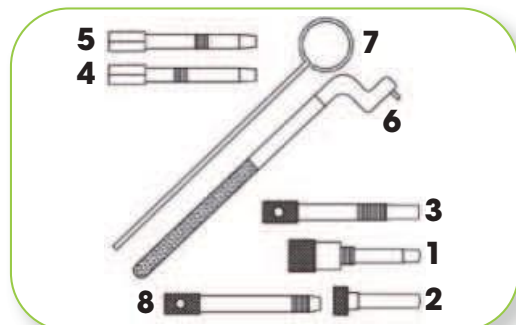

### Timing tool set for JEEP GRAND CHEROKEE 3.0 CRD (Multijet (from 2011))

#### Models:

*JEEP:* Grand Cherokee

**Engine:** 3.0 CRD/Multijet

**Engine code:**

EXF VM23D; EXF VM44D; EXF

CODE	€/Pz
FG 192/JE9	285,00



CODE	DESCRIPTION	€/Pz
1: FG 192/JE9-1	Camshaft alignment tool (RH bank)	120,00
2: FG 192/JE9-2	Camshaft alignment tool (LH bank)	140,00
3: FG 192/JE9-3	Tensioner locking pin (2 pcs)	6,00
4: FG 192/JE9-4	Crankshaft timing pin	65,00

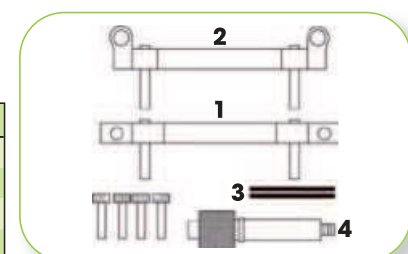



### Timing tool set OPEL 1.0, 1.2, 1.4 - CHAIN

**Models:**

Corsa; Combo; Agila; Astra; Meriva; Tigra

**Engine:** 1.0 12V; 1.0 16V; 1.2 16V; 1.4 16V

**Engine code:** X10XE, Z10XE, Z10XEP, Z12XE, Z12XEP, Z14XEP, Z14XEL

CODE	€/Pz
FG 192/OP5	115,00

CODE	DESCRIPTION	€/Pz
1: FG 192/OP5-1	Camshaft position (CMP) sensor disc setting tool	67,00
2: FG 192/OP5-2	Tensioner locking tool 4mm	6,50
3: FG 192/OP5-3	Timing chain tensioner locking pin 2,5 mm	6,50
4: FG 192/OP5-4	Crankshaft locking pin	21,00
5: FG 192/OP5-5	Camshaft locking tool	15,00

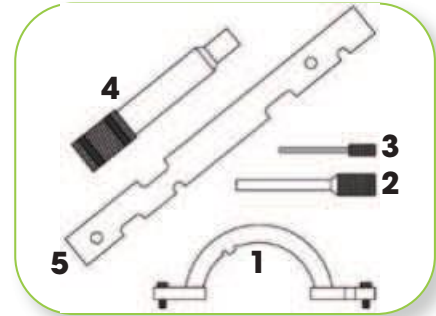

### Updating set for FG 192/OP5

**It permits the timing also for below motors:**

Adam, Ampera, Astra-J, Insignia, Meriva-B, Mokka, Zafira-C Tourer, Astra-G, Astra-H, Barina, Meriva-A, Tigra-B

**Additional engines :** 1.0 ecoFLEX, 1.2 ecoFLEX, 1.4 ecoFLEX, 1.4 Turbo ecoFLEX

**Additional engine code :** LWD, L2Z, LDD, LUU/A14XFL, LDD/A14XEL, LDD/A14XER, LUJ/A14NEL, LUJ/A14NET, A10XEP, A12XEL, AA12XER, A14XER, A14NEL, LUJ/A14NET, LUH/A14NEL, A14NET

CODE	€/Pz
FG 192/OP7B	230,00

### Timing tool set for OPEL 1.0, 1.2, 1.4 Chain and ecoFLEX



**Models:**

Adam, Agila, Ampera, Astra-J, Corsa-D, Insignia, Meriva-B, Mokka, Zafira-C Tourer, Corsa-B, Corsa-C, Astra-G, Astra-H, Combo, Combo-C, Barina, Meriva-A, Tigra-B

**Engine:** 1.0, 1.0 ecoFLEX, 1.2, 1.2 ecoFLEX, 1.4, 1.4 ecoFLEX, 1.4 Turbo ecoFLEX,

**Engine code:** LWD, L2Z, LDD, LUU/A14XFL, LDD/A14XEL, LDD/A14XER, LUJ/A14NEL, LUJ/A14NET, A10XEP, A12XEL, A12XER, A14XER, A14NEL, LUJ/A14NET, LUH/A14NEL, A14NET

CODE	€/Pz
FG 192/OP7	325,00



### Timing tool set for OPEL 1.4-2.2 16V ECOTEC

**Models:**

Astra F, G e H; Corsa B e C; Combo; Tigra; Vectra B e C; Zafira A e B; Meriva; Signum; Calibra; Omega B; Frontera A e B

**Engine:** 1.4 16V; 1.6 16V; 1.8 16V; 2.0 16V; 2.2 16V

**Engine code: 1.4 16V:** X14XE, Z14XE, X16SEJ, X16XE, X16XEL, Y16XE, Z16XE, Z16YNG

**1.8 16V:** C18XEL, X18E1, X18XE, X18XE1, Z18XE, Z18XEL

**2.0 16V:** C20SEL, X20XE, Z20LEH; Z20LEL; Z20LER; Z20LET

**2.2 16V:** X22SE, X22XE, Y22SE, Y22XE, Z22X

CODE	€/Pz
FG 192/OP2	55,00





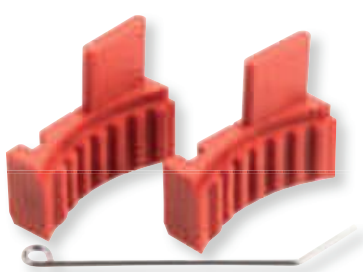

### Timing tool set for OPEL 1.6 16V



**Models:**

Astra G e H; Astra H Turbo; Corsa D

**Engine:** 1.6 16V

**Engine code:** Z16XE1, Z16XER, Z16XEP, Z16LET, Z16LER

CODE	€/Pz
FG 192/OP3	55,00



### Timing tool set for OPEL 1.0/1.4 B10/B14



**Models:** Astra-K; Karl; Karl Rocks; Mokka X; Viva

**Engine:**

1.4; 1.4 Turbo; 1.0; 1.0 ecoFLEX; 1.0 LPG ecoFLEX;

1.0 LPG ecoFLEX

**Engine code:** LV7/B14XE; LE2/B14XFL; LE2/B14XFT; L5Q/B10XE; LWT/B10XL

CODE	€/Pz
FG 192/OP3B	245,00



### Timing tool set for OPEL 1.0, 1.4 B10/B14



**Models:**

Adam; Adam Rocks; Astra-K; Corsa-E; Mokka X

**Engine:**

1.0; 1.0 Turbo SIDI; 1.0 Turbo SIDI ecoFLEX; 1.4; 1.4 Turbo

**Engine code:** LE1/B10XFL; LE1/B10XFT; LE1/B10XHL; LV7/B14XE; LE2/B14XFL; LE2/B14XFT

CODE	€/Pz
FG 192/OP3A	110,00



### Timing tool set for OPEL 1.3 CDTi

**Models:**

Astra, Corsa, Agila, Combo, Meriva

**Engine:** 1.3 CDTi

**Engine code:** Z13DT, Z13 DTH, Z13 DTJ

CODE	€/Pz
FG 192/OP4	105,00

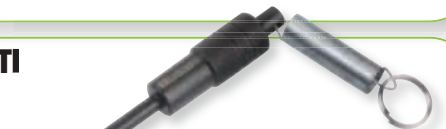

### Flywheel locking tool for OPEL 1.3 CDTi



CODE	€/Pz
FG 192/OP1	16,00



### Timing tool set for OPEL 1.3 CDTi

**Models:** Corsa-E

**Engine:** 1.3 CDTi

**Engine code:** LKU/B13DTE; LKV/B13DTC; LKU/B13DTR

CODE	€/Pz
FG 192/OP4D	550,00



### Timing tool set OPEL 1.6 CDTi e 1.6 SIDI Turbo (from 2013)



**Models:**

Astra-J; Astra-K; Insignia; GTC; Meriva-B; Mokka; Zafira-C Tourer; Cascada

**Engine:** 1,6 CDTi; 1.6CDTi ecoFLEX; 1.6SIDI Turbo;

1.6SIDI Turbo ecoFLEX

**Engine code:** LVL/B16DTH; LVL/B16DTJ; LVL/B16DTN; LVM/B16DTL; LVM/B16DTC; LWQ/B16DTC; LWQ/B16DTE; LVK/ B16DTR; LWV/B16DTU; LWC/A16SHT; LWC/B16SHL; LWC/B16SHT; LVP/A16XHT

CODE	€/Pz
FG 192/OP4B	355,00



### Timing tool set OPEL 2.0 CDTI, CHEVROLET 2.0D VCDi

CODE	€/Pz
FG 192/OP6	110,00

**Models:**

Antara, Captiva, Epica, Nubira, Lacetti, Evada

**Engine:** 2.0 CDTi

**Engine code:** Z20DMH, Z20DM, Z20S1, RA420



### Timing tool set for OPEL 2.0, 2.2



**Models:**

OPEL: Omega-B, Vectra-B, Astra-G, Zafira-A, Signum, Frontera-B  
SAAB: 9-3, 9-5

**Engine:** 2.0 DTi, 2.2 DTi, 2.2 TiD

**Engine code:** X20DTH, X20DTL, Y20DTH, X22DTH, Y22DTR, D223L

CODE	€/Pz
FG 192/OP8	180,00



### Timing tool set OPEL 2.0 CDTi



**Models:**

OPEL: Cascada; Insignia-A Country Tourer;  
Insignia-A; Zafira-C Tourer

**Engine:** 2.0 CDTi, 2.0 CDTiEcoflex

**Engine code:** LFS/B20DTH

CODE	€/Pz
FG 192/OP15	520,00



### Timing tool set for OPEL, SAAB 2.0 TURBO



**Models:**

OPEL: Signum, Vectra-C

SAAB: 9-3

**Engine:** 2.0, 2.0 Turbo

**Engine code:** Z20NET; B207E; B207L

CODE	€/Pz
FG 192/OP10	210,00



### Timing tool set for Opel, Saab, Chevrolet 2.0 e 2.4 Turbo



**Models:**

Opel: Astra; Astra-J; Insignia; Antara

Saab: 9-5

Chevrolet: Captiva; HHR; Malibu

**Engine:** 2.0 e 2.4 D (OPC; OPC/VXR); Turbo; Turbo ecoFLEX

**Engine code:** LHU/A20NFT; LKD/A20NHT; A24XE; A24XF; LE5; LE9

CODE	€/Pz
FG 192/OP9	360,00



## Timing tool set PSA 1.4 e 1.6HDI

### Models:

**Peugeot:** 107, 206, 206 Cc 207, 307, 307 Cc, 308, 406, 406 Coupe, 407, 607, 806, Expert I/II, Expert III, 807

**Citroen:** Xsara Picasso, Xsara II, C1, C3, C3 Pluriel, C4, C4 Picasso, Grand Picasso, Berlingo/Berlingo First I/II, C5 I, C5 II, C8, Dispatch/Jumpy III, Synergie/Evasion

**Cil:** 1,4D Hdi, 1,6D Hdi, 1,8, 1,8 16V, 2,0, 2,0 16V, 2,0 Hpi, 2,0 Gti 180/RC, 2,2

**Engine code:** EW10A(RFJ), EW10D(RLZ), EW10J4(RFR), W10J4L5(RFN), EW10J4S(RFK), EW12J4(3FY/3FZ), EW12J4/5(3FZ), EW7A(6FY), EW7J4(6FZ), 9H Y/9HZ(DV6TED4), 9HX(DV6ATED4), 9HW(DV6BTD4), 9HU(DV6UTED4), DV4TD (8HT/8HX/8HW/8HV/8HY/8HZ)

CODE	€/Pz
FG 192/PS13	205,00

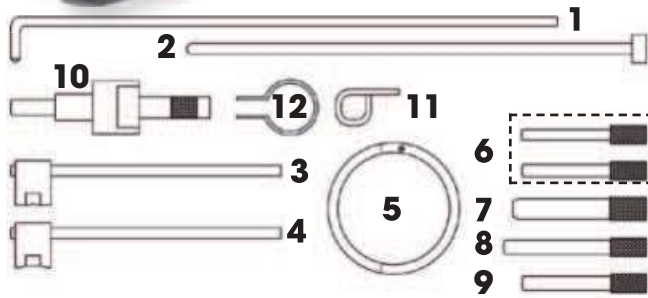

CODE	DESCRIPTION	€/Pz
1: FG 192/PS13-1	Tensioner pin	16,10
2: FG 192/PS13-2	Tensioner pulley locking tool	16,10
3: FG 192/PS15-6	Tensioning tool	14,29
4: FG 192/PS15-5	Tensioning tool	14,29
5: FG 192/PS13-5	Tensioner pulley adjusting tool	51,50
6: FG 192/PS13-6	Timing pin	25,80
7: FG 192/FO24-22	Timing pin	8,10
8: FG 192/PS15-7	Timing pin	15,00
9: FG 192/FO24-23	Timing pin	15,00
10: FG 192/PS13-10	Flywheel/drive plate locking tool	32,20
11: FG 192/PS13-11	Locking Pin	4,80
12: FG 192/PS13-12	Crankshaft sprocket centralizing tool	3,20



## Timing tool set PSA

### 1.9D, 2.0D HDi, 2.2D HDi

### Models:

Xsara; 307; 406; 607; 806; Expert I/II; 807; 206; 306; Boxer; 406 Coupe

**Engine:** 1.9D, 2.0D HDi, 2.2D HDi

**Engine code:** DW8/L3(WJZ), DW10TD(RHY), W10ATED(RHS), W10ATED(RHZ), DW10ATED4/L4(RHT), DW10BTED(RHX), W10ATED4(RHW), DW10TD(RHY), DW10UTD(RHV), W12ATED(4HX), DW12ATED(4HZ), DW12UTED(4HY), DW8(WJY), DW8/L/W3(WJZ), DW8B/L4(WJY)

CODE	€/Pz
FG 192/PS15	270,00

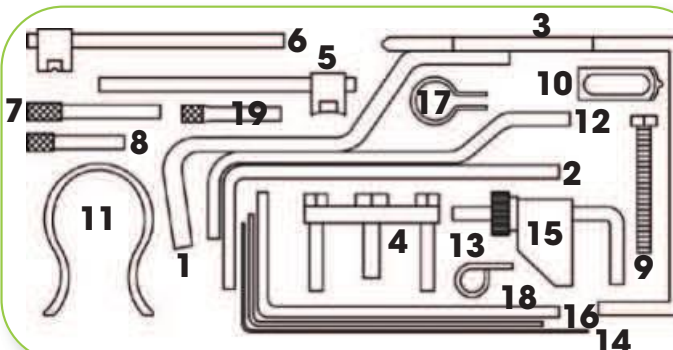

CODE	DESCRIPTION	€/Pz
1: FG 192/PS15-1	Flywheel locking tool	9,10
2: FG 192/PS15-2	Flywheel locking tool	10,37
3: FG 192/PS15-3	Flywheel timing pin -8 mm	4,80
4: FG 192/PS15-4	Crankshaft pulley puller	26,03
5: FG 192/PS15-5	Tensioning tool	14,29
6: FG 192/PS15-6	Tensioning tool	14,29
7: FG 192/PS15-7	Flywheel locking tool 8mm	15,00
8: FG 192/PS15-8	Flywheel locking tool 6mm	15,00
9: FG 192/PS15-9	M8x80mm	1,27
10: FG 192/PS15-10	Flywheel locking tool	9,10
11: FG 192/PS15-11	Timing belt retaining clip	5,19
12: FG 192/PS15-12	Flywheel timing pin	9,10
13: FG 192/PS13-11	Tensioner retaining tool	3,91
14: FG 192/PS15-14	Tensioner locking tool	7,83
15: FG 192/PS15-15	Timing belt clamp	98,83
16: FG 192/PS15-16	Auxiliary drive belt tensioner pulley locking tool	6,46
17: FG 192/PS15-17	Crankshaft sprocket centralizing tool	5,19
18: FG 192/PS15-18	Flywheel timing pin	7,80
19: FG 192/PS15-19	Exhaust camshaft sprocket timing pin	15,00



### Timing tool set PSA, LAND ROVER, JAGUAR

Models:

PEUGEOT: 407, 607

CITROEN: C5 III, C6

LAND ROVER: Discovery 3, Discovery 4, Range Rover Sport.

JAGUAR: S-Type, XF, XJ6.

Engine: 2.7, 2.7 TDV6, 2.7 TDVi, 2,7 HDI

Engine code: 276DT, 276DT (7B/7G), 7G,  
UHZ (DT17BTED4), DT17TED4 (UHZ)



CODE	€/Pz
FG 192/PS7	215,00

CODE	DESCRIPTION	€/Pz
1: FG 192/PS7-1	Flywheel locking tool (AT)	45,00
2: FG 192/PS7-2	Flywheel timing tool (MT)	53,00
3: FG 192/PS7-3	Camshaft sprocket aligning tool	5,10
4: FG 192/PS7-4	Camshaft sprocket timing pins	12,70
5: FG 192/PS7-5	Water pump pulley locking tool	6,40
6: FG 192/PS7-6	Flywheel locking tool	12,70
7: FG 192/PS15-11	Timing belt retaining clip	5,19
8: FG 192/PS7-8	Water pump support	50,00

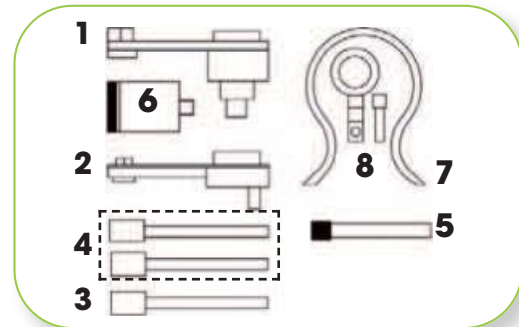

### Timing tool set PSA / FIAT 2.5D, 2.8 - CHAIN

Models:

PEUGEOT: Relay/Jumper

CITROEN: Boxer, Boxer II

FIAT: Ducato, Croma, Talento

Engine: 2.8, 2.8 TDi, 2.8 HDI

Engine code: 8140,63, 8140.43S, 8140.43N, 8144,67,  
8140,27, 8140.47R, 8144,21, 8140,47



CODE	€/Pz
FG 192/PS4	55,00

### Timing tool set PSA 1.0VTi, 1.2VTi

Models:

PEUGEOT: 208, 308, 2008

CITROEN: C3 III, DS3/DS3 Cabrio

Engine: 1,0 VTi, 1,2 VTi

Engine code: EBO(ZMZ), EB2(HMZ), ZMZ(EBO)



CODE	€/Pz
FG 192/PS2	215,00

### Stretch belt installation tool for PSA e OPEL 1.0/1.2 3 cylinders (from 2012 on)

Models:

Peugeot: 108, 208, 301, 308, 408, 2008, 3008, 5008, Partner

Opel: Crossland X

Citroen: C1, C3, C3 Picasso, C3 Aircross, C4,

C4 Picasso, C4 Cactus, Berlingo, DS3, DS4, DS4S, DS5LS

Engine:

1.0, 1.2 benzina 3 cilindri



CODE	€/Pz
FG 192/PSA	35,00

### Timing tool set PSA 1.4 16V

Models:

CITROEN: Berlingo/Berlingo First I/II; C2

PEUGEOT: 1007; 206; 207; 307

Engine: 1.4 benzina a cinghia

Engine codes: KFW(TU3A); KFW(TU3JP/L4); KFW(TU3A);  
KFW(TU3JP); ET3J4(KFU); ET3JP4(KFU); TU3A(KFV)





### Timing tool set RENAULT & NISSAN 1.4, 1.6 16V, 1.8 16V, 2.0 16V

**Models:**

Clio, Megane, Megan Scenic, Laguna, Espace, Grand Espace, Kubistar, Primastar

**Engine:** 1.4, 1.6 16V, 1.8 16V, 2.0 16V

**Engine code:** K4J, K4M, F4P, F4R

CODE	€/Pz
FG 192/RE5	188,00



CODE	DESCRIPTION	€/Pz
1: FG 192/RE3-1	Camshaft sprocket locking tool	71,00
2: FG 192/RE5-2	Camshaft locking bar	56,90
3: FG 192/RE3-3	Crankshaft timing pin (1.4/1.6)	15,00
4: FG 192/RE3-2	Camshaft timing pin (1.8/2.0)	9,70
5: FG 192/RE5-5	Crankshaft locking pin (1.8/2.0)	10,70

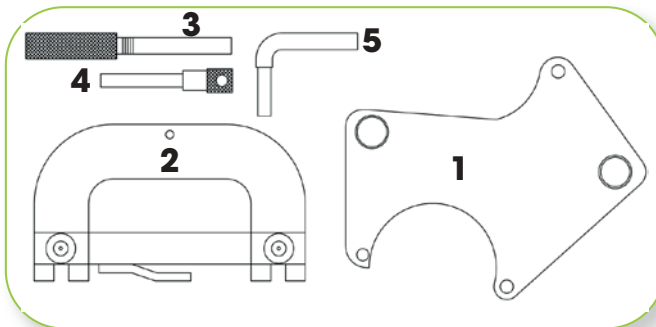

### Timing tool set RENAULT 1.5dCi, 1.4 & 1.6 16V

**Models:** Clio, Kangoo, Megane, Scenic, Grand Scenic II, Clio III

**Engine:** 1.5dCi, 1.4 & 1.6 16V

**Engine code:** 1.5 dCi: K9K dal 2001;

1.4&1.6 16V: K4M, 708, 716, 730, 732, 750, 752, 753, 760, 761, 766, 782, 800, 801, 812, 813

CODE	€/Pz
FG 192/RE3	115,00



CODE	DESCRIPTION	€/Pz
1: FG 192/RE3-1	Camshaft sprocket locking tool	71,00
2: FG 192/RE3-2	Camshaft timing pin (1.8/2.0)	9,70
3: FG 192/RE3-3	Crankshaft timing pin (1.4/1.6)	15,00

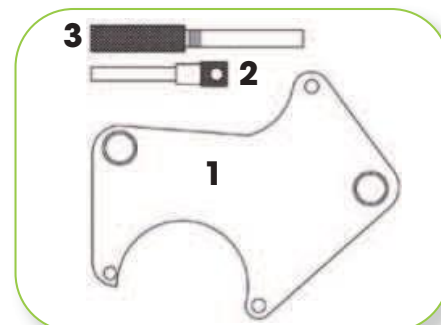

### Timing tool set RENAULT, NISSAN 1.6 dCi

**Models:**

*Nissan:* Qashqai; Qashqai+2; X-Trail

*Renault:* Espace; Fluence; Megane III; Scenic/Grand Scenic III; Trafic III

**Engine:** 1.6dCi

**Engine code:** 1.5 dCi: K9K dal 2001;

R9M; R9M 410; R9M 409; R9M 452; R9M 402;

R9M 404; R9M 408; R9M 413; R9M 450; R9M 452

CODE	€/Pz
FG 192/RE4	245,00



CODE	DESCRIPTION	€/Pz
1: FG 192/RE4-1	Camshaft holding/alignment tool	90,00
2: FG 192/RE4-2	Crankshaft timing pin	18,00
3: FG 192/RE6-5	Crankshaft pulley holding tool	47,30
4: FG 192/RE6-6	Two-piece inlet camshaft gear alignment tool	57,80

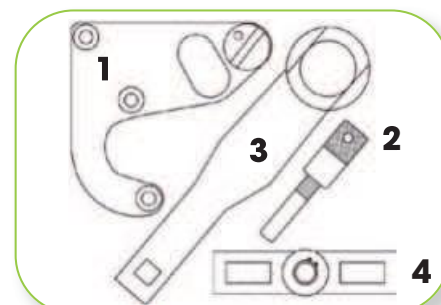



## Camshaft sprocket locking plate for RENAULT 1.8 and 2.0 16V

**Models:** Clio III; Laguna III Turbo/GT Turbo; Megane II; Megane III; Laguna; Megane; Scenic  
**Engine:** 1.8 e 2.0 16V benzina  
**Engine code:** F4R 830; F4R 832; F4RT 800; F4RT 802; F4RT 820; F4RT 810; F4RT 811; F4RT 813; F4RT 774; F4RT 776; F4RT 872; F4RT 874; F4RT 870; F4RT 874; F4P 760; F4P 720; F4P 722

CODE	€/Pz
FG 192/RE7	98,00



## Timing tool set RENAULT, OPEL, NISSAN 1.5, 1.9, 2.2, 2.5 DCI

**Models:** Clio, Kangoo, Megane, Scenic, Grand Scenic, Modus, Logan, Almera, Micra, Qashqai, Kubistar, Laguna, Trafic II, Movano, Vivaro, Primera, Interstar, Primastar, Espace, Grand Espace  
**Engine:** 1.5, 1.9, 2.2, 2.5 dCi  
**Engine code:** 1.5 dCi: K9K, 1.9 dCi: F9Q, 2.2 dCi: G9T, 2.5 dCi: G9U, 750, 752, 753, 760, 761, 766, 782, 800, 801, 812, 813

CODE	€/Pz
FG 192/RE13	315,00

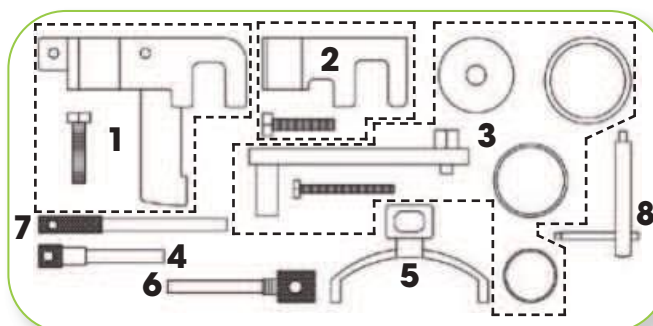

CODE	DESCRIPTION	€/Pz
1: FG 192/RE13-1	Exhaust camshaft locking tool	65,00
2: FG 192/RE13-2	Inlet camshaft locking tool	42,50
3: FG 192/RE13-3	Tensioning tool	115,00
4: FG 192/RE3-2	TDC timing pin	7,20
5: FG 192/RE13-5	Injection pump sprocket locking tool	30,00
6: FG 192/RE13-6	Crankshaft timing pin	12,00
7: FG 192/RE13-7	Crankshaft Timing Pin	9,00
8: FG 192/RE13-8	Injection pump gear holding tool	15,00



## Injection pump sprocket puller RENAULT, OPEL, NISSAN

**Models:** Nissan: Interstar  
Renault: Espace/Grand Espace IV; Laguna II; Master II; Trafic II; Vel Satis  
Opel: Movano-A; Vivaro  
**Engine:** 2.2 dCi/DTi; 2.5 dCi/DTi/CDTi  
**Engine code:** G9U...; G9T...

CODE	€/Pz
FG 192/RE13A	135,00



## Timing tool set RENAULT 2.0D dCi

Suitable also for OPEL VIVARO e NISSAN PRIMASTAR

**Models:** Renault: Scenic, Grand Scenic II, Megane II, Laguna, Espace, Grand Espace, Trafic, Koleas  
Nissan: Qashqai, Primastar  
Opel: Vauxhall: Vivaro  
**Engine:** 2.0D dCi  
**Engine code:** RENAULT: M9R 700, 721, 724, 740, 752, 760, 761, 780, 805, 830, 832, 833  
NISSAN: M9R, M9R780  
OPEL: M9R780, 750, 752, 753, 760, 761, 766, 782, 800, 801, 812, 813

CODE	€/Pz
FG 192/RE6	240,00

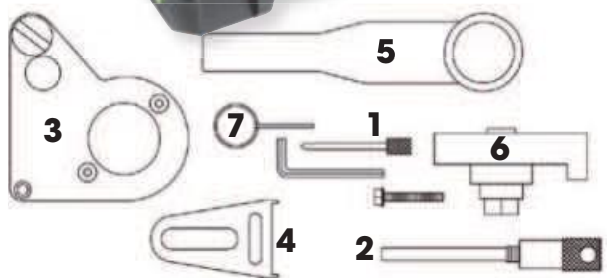

CODE	DESCRIPTION	€/Pz
1: FG 192/RE6-4	Auxiliary belt tensioner locking pin (3,60mm)	6,50
2: FG 192/RE6-2	Crankshaft Locking pin	13,10
3: FG 192/RE6-3	Locking tool / camshaft alignment tool + M6 bolt	52,50
4: FG 192/RE6-4	Flywheel locking tool	18,40
5: FG 192/RE6-5	Crankshaft pulley holding tool	47,30
6: FG 192/RE6-6	Two-piece exhaust camshaft gear alignment tool	57,80
7: FG 192/RE6-7	Crankshaft pulley holding tool (2,90mm)	2,60





### Pulley locking tool for VAG 1.4 16V e 1.6 16V



#### Models:

**Volkswagen:** Polo, Lupo, Bora, Golf, Golf Estate, Caddy, Caddy Maxi, Polo Classic, Beetle

**Skoda:** Fabia, Octavia, Octavia Tour, Octavia II

**Seat:** Cordoba, Ibiza, Arosatoledo, Leon, Inca

**Audi:** A2

**Engine:** 1.4 16V e 1.6 16V

**Engine code:** AFH, AFK, AHW, AJV, AKQ, APE, AQQ, ATN, AUA, AUB, AUS, AXP, AZD, BAD, BBY, BBZ, BCA, BCB, BKY

CODE	€/Pz
FG 192/VW1	55,00



### Belt holder for VW, AUDI, SEAT, SKODA



CODE	€/Pz
FG 192/VW1B	28,00



### Belt holder for VW, AUDI, SEAT, SKODA



CODE	€/Pz
FG 192/VW1C	30,00



### Belt holder for VW, AUDI, SEAT, SKODA



CODE	€/Pz
FG 192/VW1D	32,00

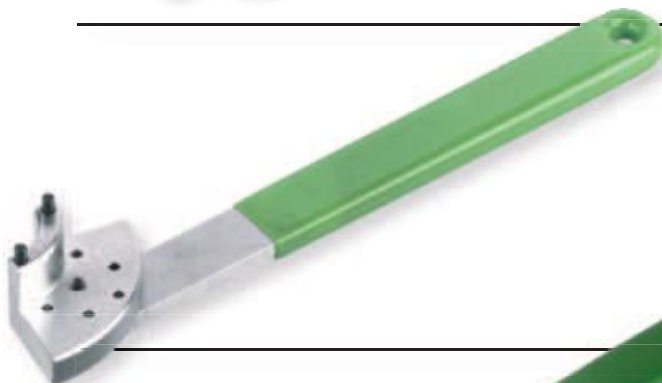

### Belt holder for VW, AUDI, SEAT, SKODA



CODE	€/Pz
FG 192/VW1E	48,00



### Camshaft sprocket holding tool for VW, AUDI, SEAT, SKODA

CODE	€/Pz
FG 192/VW1F	95,00





### Timing tool set AUDI 3.0 V6 BELT DRIVE



**Models:**

AUDI: A4, A4 Cabrio, A4 quattro, A6, A8

**Engine:** 3.0 Benzina

**Engine code:** ASN, BBJ

CODE	€/Pz
FG 192/VW5B	275,00

CODE	DESCRIPTION	€/Pz
1: FG 192/VW5B-1	Crankshaft locking tool	11,20
2: FG 192/VW5B-2	Camshaft sprocket adjusting tool	14,00
3: FG 192/VW5B-3	Tensioner locking pins	9,80
4: FG 192/VW5B-4	Camshaft locking tools (2 pcs)	291,00

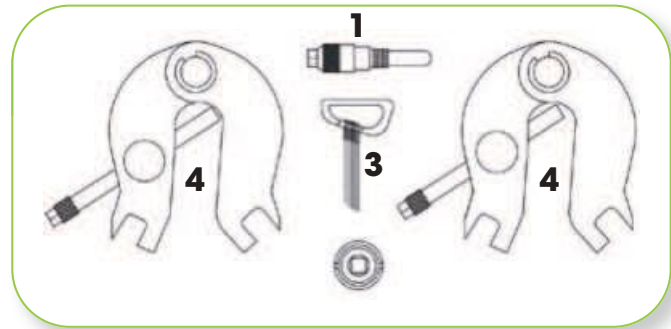

### Timing tool set for VAG 1.0 3 cylinders

**Models:**

SEAT: Mii

SKODA: Citigo, Fabia

VOLKSWAGEN: Up, Polo

**Engine:** 1.0 Benzina

**Engine code:** ASN, BBJ: CHYA, CHYB, CPGA

CODE	€/Pz
FG 192/VW4B	260,00

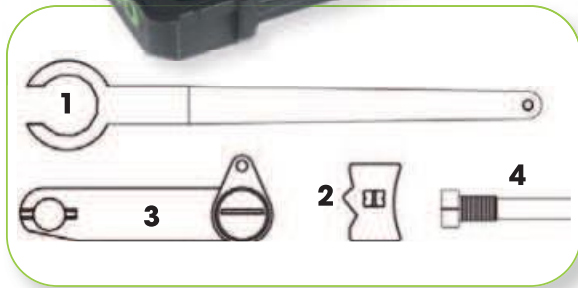

CODE	DESCRIPTION	€/Pz
1: FG 192/VW4B-1	Tensioner pulley holding tool	92,00
2: FG 192/VW4B-2	Camshaft locking tool	15,00
3: FG 192/VW4B-3	Camshaft timing tool	118,00
4: FG 192/VW4B-4	Crankshaft locking tool	18,00

### Camshaft alignment tools suitable for VOLKSWAGEN, AUDI, SKODA 1.2 TSi



**Models:**

VOLKSWAGEN: Beetle/Maggiolino, Caddy/Caddy Maxi, Golf Plus, Golf VI, Golf VI Cabrio, Golf VI Estate, Jetta, Polo, Touran

AUDI: A1, A2, A3 Cabrio

SEAT: Altea/Altea XL, Ibiza, Leon

SKODA: Fabia II, Octavia, Praktik, Roomster, Yeti

**Engine:** 1.2 TSi

**Engine code:** CBZA, CBZB, CBZC

CODE	€/Pz
FG 192/VW2	72,00







### Timing tool set VAG 1.2 3 cilindros 6v e 12v

**Models:**

*Volkswagen:* Polo, Fox    *Seat:* Cordoba, Ibiza  
*Skoda:* Fabia, Roomster  
*Seat:* Cordoba, Ibiza

**Engine:** 1.2 3 CIL. 6V e 12V

**Engine code:** AWY, BMD, AZQ, BME

CODE	€/Pz
FG 192/VW4	142,00

CODE	DESCRIPTION	€/Pz
1: FG 192/VW4-1	Camshaft alignment tool (2 pcs)	41,20
2: FG 192/VW4-2	Camshaft alignment tool	45,80
3: FG 192/VW4-3	Flywheel locking tool	36,60

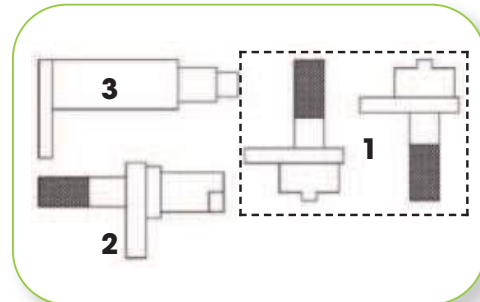

### Timing tool set VAG 1.4 FSI, 1.6 FSI, 1.4 TSI, 1.6 16V

**Models:**

*Volkswagen:* Polo; Golf V; Touran; Golf Plus; Eos; Golf Plus; Jetta; Passat; Beetle; Tiguan; Golf VI; Scirocco; Passat; Sharan  
*AUDI:* A1; A3  
*SEAT:* Ibiza; Toledo; Leon; Althea; Alhambra; Cordoba  
*SKODA:* Fabia II; Roomster; Rapid; Rapid Spaceback; Yeti; Octavia II; Superb II

**Engine:** 1.4 FSI, 1.6 FSI, 1.4 TSI, 1.6 16V

**Engine code:**

AUX; BKG; BLN; BAG; BLF; BLP; CAVD; CAVA; CAVB; CAVC; CAVE; CTHD; CAXA; CAVA; CAVD; BMY; CDGA; CKMA; CTHA; CTHB; CTHC; BTS; CTHE; CNKA; CFNA

CODE	€/Pz
FG 192/VW3B	270,00



### Timing tool set VAG 1.2/1.4 TSi e TFSi

**Models:**

A3,A3 Sportback,A3 Saloon,A3 Cabrio,A3 Sedan,A1,A1 Sportback,Q3  
 Leon, Leon ST, Ibiza  
 Fabia III, Fabia III Estate, Octavia III  
 Polo, Jetta, Golf VII, Golf VII Estate, Golf VII Wagon, Passat, Golf SV

**Engine:** 1,2TSI, 1,2TFSI, 1,4TSI, 1,4TFSI, 1,4 TSI ACT, 1,4GTE, 1,4 GTE Hybrid, 1,4TGI BlueMotion, 1,4g-tron, 1,4e-tron, 1,4TFSI COD

**Engine code:** CJZA, CJZB, CJZC, CJZD, CYVD, CYVA, CYVB, CZCA, CXSA, CXSB, CPWA, CHPB, CUKB, CZDA, CPTA, CZEA

CODE	€/Pz
FG 192/VW4C	305,00



CODE	DESCRIPTION	€/Pz
1: FG 192/VW4C-1	Camshaft timing tool	76,00
2: FG 192/VW4C-2	Camshaft timing tool	86,00
3: FG 192/VW4C-3	Camshaft timing tool locking pin	11,90
4: FG 192/VW4C-4	Camshaft timing check pin	14,50
5: FG 192/VW3-4	Crankshaft locking tool	19,80
6: FG 192/VW4C-6	Tensioner pulley holding tool	21,50
7: FG 192/VW7-4	Auxiliary drive belt tensioner locking pin	10,00

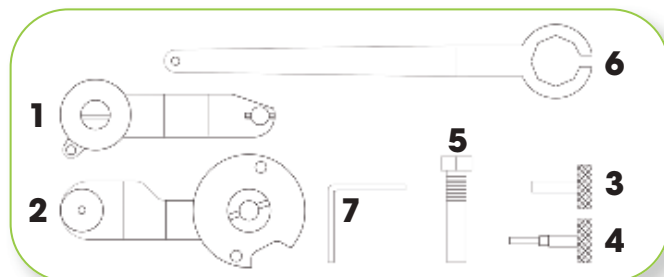

## Timing tool set VAG 1.8 e 1.8T

**Models:** AUDI: A3; S3; TT ;A6 - VW: Golf; Passat  
SEAT: Ibiza; Cordoba ; Leon; Toledo; Alhambra Octavia

**Engine:** 1.8, 1.8 T benzina

**Engine code:** ADR, AEB, AFY, AGN, AGU, AJH, AJL, AJP, AJQ, AMK, AMU, ANB, APG, APH, APP, APT, APU, APX, APY, AQA, AQX, AGR, ARX, ARY, ARZ, ATC, ATW, AUM, AUQ, AVC, AWC, AWP, AWU, AWV, AYP, BAM, BEA, BFV, BKF, BNU, BVP, BVR



CODE	€/Pz
FG 192/VW5	40,00



## Timing tool set VAG 1.8/2.0 TFSi 4V (CHAIN)

**Models:**

VW: Tiguan; CC; Golf VI; Passat; Beetle/Maggiolino; Eos; Scirocco.

AUDI: A4; A4 quattro; A5 Coupe/Cabriolet; A5 Sportback; Q5; TT

SKODA: Octavia II; Superb; Yeti

**Engine:** 1.8 TFSi; 2.0 TFSi

**Engine code:**

CCZA; CCZB; CCZC; CCZD; CDAA; CDAB; CDHB; CDNC; CFKA; CDNB; CETA; CJEB; CESA; CDHA

CODE	€/Pz
FG 192/VW8	340,00

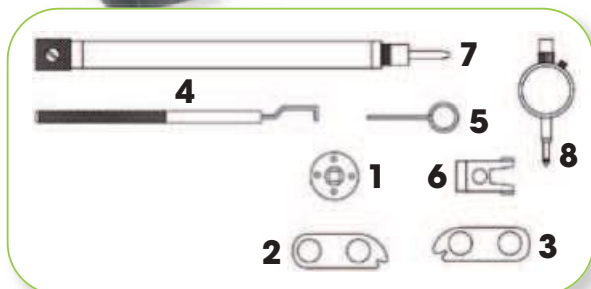

CODE	DESCRIPTION	€/Pz
1: FG 192/VW8-1	Camshaft Control Valve Removal Tool	37,80
2: FG 192/VW8-2	Camshaft Clamp (Exhaust)	65,00
3: FG 192/VW8-3	Camshaft Clamp (Inlet)	65,00
4: FG 192/VW8-4	Oil Pump Tensioner Locking Pin	16,00
5: FG 192/VW8-5	Tensioner Locking Pin 1.4mm	4,30
6: FG 192/VW8-6	Timing Chain Tensioner	5,40
7: FG 192/PM	Dial gauge holder	70,00
8: FG 192/CO	DTI Gauge	88,00

## Crankshaft assembling tool for VAG 1.8/2.0 TFSi 4V (CHAIN)

CODE	€/Pz
FG 192/VW8C	330,00

## Crankshaft seal installer tool VAG 1.8/2.0 TFSi 4V

CODE	€/Pz
FG 192/VW8D	480,00

## Crankshaft holding tool for VAG 1.8/2.0 TFSi 4V (CHAIN)

CODE	€/Pz
FG 192/VW8B	120,00

## Timing tool set VW / AUDI 2.0 FSI & TFSI

**Models:**

AUDI: A3, A4, TT, A4 Cabrio, S3

VOLKSWAGEN: Golf VI, Touran, Passat, Eos, Jetta, Golf Plus, Scirocco, Golf V

**Engine:** 2.0, 2.0 FSI, 2.0 TFSI

**Engine code:** AXW, BHD, BMB, AWA, AXX, BPY, BWA, BUL, BPJ, BGB, BWE, BLR, BLX, BLY, BVY, BWT, BPG, CDLA, CDLB, CDLC, CDMA, AXW, CDLF

CODE	€/Pz
FG 192/VW7C	205,00





### Timing tool set AUDI 2.5 TFSI / RS PLUS

**Models:**  
RS Q3; Q3; TT

**Engine:** 2.5 TFSI / RS PLUS

**Engine code:** CZGA; CZGB; CEPA; CEPB; CTSA

CODE	€/Pz
FG 192/VW7D	360,00

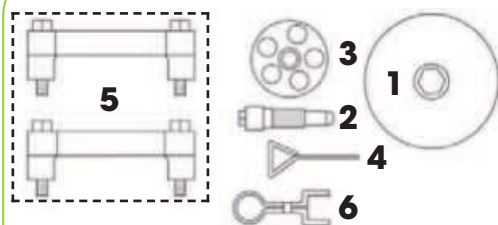

CODE	DESCRIPTION	€/Pz
1: FG 192/VW7D-1	Camshaft adjuster holding tool	50,00
2: FG 192/VW7D-2	Crankshaft alignment pin	13,90
3: FG 192/VW7D-3	Crankshaft pulley bolt adaptor	85,00
4: FG 192/VW7-5	Timing chain tensioner locking pin	7,10
5: FG 192/VW7D-5	Camshaft locking tool (2 pcs)	195,00
6: FG 192/VW7D-6	Timing chain tensioner locking pin (2 pcs)	11,50



### Timing tool set VW 1.2, 1.4, 1.6, 1.9, 2.0D TDI PD

**Models:**

**Volkswagen:** Bora, Golf, Golf Estate, Golf Plus, Passat, Lupo, Polo, Sharan, Beetle, Touran, Transporter, Jetta, Caddy, Caddy Maxi, Eos

**Audi:** A2, A3, A4, A4 Cabrio, A4 Quattro, A6

**Seat:** Arosa, Cordoba, Ibiza, Alhambra, Leon, Toledo, Altea, Altea XI

**Skoda:** Fabia, Octavia, Octavia Tour, Octavia li, Superb, Roomster

**Engine:** 1.2D TDI PD, 1.4D TDI PD, 1.6D TDI PD, 1.9D TDI PD, 2.0D TDI PD

**Engine code:** AJM, AMF, ANU, ANY, ARL, ASZ, ATD, ATJ, ATL, AUY, AVB, AVF, AVQ, AWX, AXB, AXC, AXR, AYZ, AZV, BAY, BDJ, BDK, BGW, BHC, BHW, BJB, BKC, BKD, BKE, BKP, BKQ, BLB, BLS, BLT, BMA, BMM, BMN, BMP, BMR, BMS, BMT, BNA, BNM, BNV, BPW, BPX, BRA, BRB, BRC, BRE, BRF, BRM, BRT, BRU, BSS, BSV, BSU, BSW, BTB, BUK, BUY, BUZ, BVA, BVE, BVF, BVG, BVH, BVK, BWV, BXE, BXF

CODE	€/Pz
FG 192/VW7	145,00

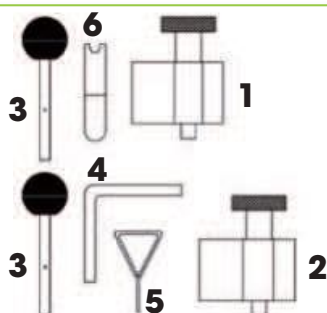

CODE	DESCRIPTION	€/Pz
1: FG 192/VW14-2	Crankshaft sprocket locking tool - round version	35,60
2: FG 192/VW7-2	Crankshaft sprocket locking tool - oval version	35,60
3: FG 192/VW7-3	Camshaft/high-pressure fuel pump locking tool (2 pcs)	14,20
4: FG 192/VW7-4	Auxiliary drive belt tensioner locking pin	10,00
5: FG 192/VW7-5	Chain tensioner locking pin	7,10
6: FG 192/FO24-15	Two-pin wrench	3,20





### Timing tool set for new VAG 1.4, 1.6, 2.0 TDi CR



**Models:**

**Volkswagen:** Golf VII, Golf VII Estate, Golf VII Wagon, Polo  
**Audi:** A3 Cabrio, A3 Saloon, A3/A3 Sportback, A4, A4 allroad, A4 quattro, A5 Coupe/Cabriolet, A5 Sportback, A6, Q5, TT  
**Seat:** Leon, Leon ST  
**Skoda:** Octavia III

**Engine:** 1.4TDI CR, 1.6TDI CR, 1.6TDI CR GreenLine/BlueMotion/Ecomotive, 2.0TDI CR / RSTDI / TDI CR Ultra

**Engine code:** CKFB, CKFC, CLHA, CLHB, CNHA, CNHC, CRBC, CRBD, CRFA, CRFC, CRKA, CRKB, CRLB, CRLC, CRMB, CRVA, CRVC, CSUA, CSUB, CUNA, CUPA, CUTA, CUSA, CUSB

CODE	€/Pz
FG 192/VW10B	380,00

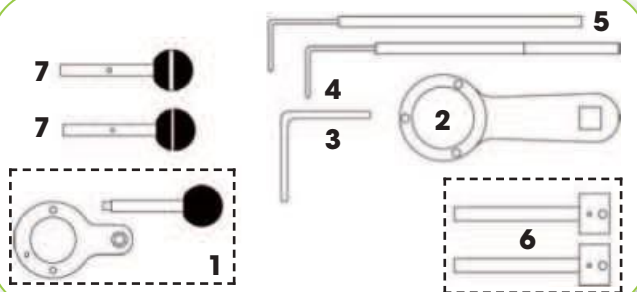

CODE	DESCRIPTION	€/Pz
1: FG 192/VW10B-1	Crankshaft sprocket locking tool	145,00
2: FG 192/VW10-7	High-pressure fuel pump sprocket holding tool	70,00
3: FG 192/VW7-4	Auxiliary drive belt tensioner locking pin	10,00
4: FG 192/VW10-6	Tensioner pulley adjusting tool	15,00
5: FG 192/VW10-5	Tensioner pulley locking tool	15,00
6: FG 192/VW10B-6	High-pressure fuel pump locking tool	72,50
7: FG 192/FO24-14	Camshaft locking tool	14,20



### Timing tool set VAG & FORD



**Models:**

**Volkswagen:** Transporter, Caddy, Golf, Golf Estate, Passat, Polo, Polo Classic, Polo Estate, Sharan, Vento, Bora, Beetle, Lupo  
**Audi:** 80, 90, 100, A6, A3, A4, A8, Allroad  
**Seat:** Cordoba, Ibiza, Toledo, Alhambra, Inca, Arosa  
**Skoda:** Felicia, Van, Pick, Up, Octavia, Octavia Tour, Fabia  
**Ford:** Galaxy

**Engine:** 1.2D TDI PD, 1.4D TDI PD, 1.6, 1.6D, 1.6D TURBO, 1.7D SDI, 1.8, 1.8 TURBO, 1.9D, 1.9D TURBO, 1.9D TDI, 1.9D TDI PD, 2.0, 2.4D, 2.5D TDI, 2.5D SDI, 3.7, 4.2

**Engine code:** 1X, 1Y, 1Z, AAB, AAT, AAZ, ABL, ABZ, ACE, ACV, ADP, ADR, AEB, AEF, AEL, AEY, AEW, AFB, AFF, AFN, AGD, AGP, AGR, AGX, AHB, AHC, AHD, AHF, AHH, AHL, AHU, AJA, AJM, AKE, AKN, AKU, AKW, ALE, ALH, ALT, AMF, ANU, ANY, AQM, ARL, ASV, ASX, ASZ, ATD, ATJ, AUJ, AVB, AVF, AVG, AVJ, AWW, AXR, AYM, AYZ, BAY, CY, JK, RA, SB

CODE	€/Pz
FG 192/VW14	295,00

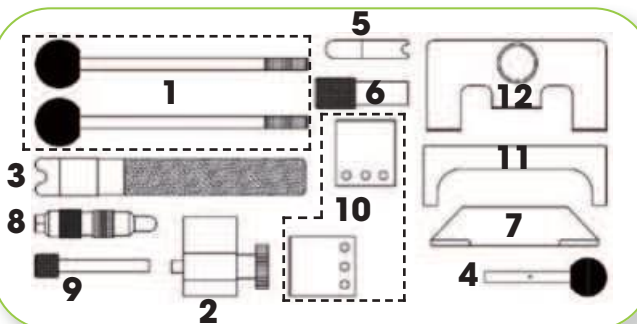

CODE	DESCRIPTION	€/Pz
1: FG 192/VW14-1	Support guides	31,20
2: FG 192/VW14-2	Crankshaft sprocket locking tool	39,00
3: FG 192/VW14-3	Two-pin wrench	46,80
4: FG 192/FO24-14	Camshaft/high-pressure fuel pump locking tool	14,20
5: FG 192/FO24-15	Tensioner locking tool	3,20
6: FG 192/VW14-6	Injection pump sprocket locking pin	11,70
7: FG 192/VW14-7	Camshaft setting bar	19,50
8: FG 192/VW14-8	Crankshaft locking tool	15,60
9: FG 192/VW14-9	Locking pin	7,80
10: FG 192/VW14-10	Camshaft aligning tool	23,40
11: FG 192/FO24-13	Camshaft setting bar	8,10
12: FG 192/VW14-12	Camshaft setting bar	31,20



## Timing tool set VW, AUDI, SEAT, SKODA 1.6, 2.0 TDI CR

### Models:

**VW:** Beetle/Maggiolino; Golf V; Golf VI Cabri; Golf VI Estate; Golf Plus; Passat; Polo; Jetta; Touran; Caddy/Caddy Maxi **AUDI:** Q5; A1; A3; A3 Cabrio; A4; A4 allroad; A4 quattro; A5 Coupe/Cabriolet; A5 Sportback; A6

**SEAT:** Ibiza; Leon; Altea / Altea XL; Toledo; Exeo

**SKODA:** Fabia II; Octavia II; Rapid; Praktik; Yeti; Roomster; Superb II

**Engines:** 1.6, 2.0 TDI CR (diesel with chain)

**Engine code:** CAYB; CAYC; CAYA; CAGA; CAGB; CAGC; CAHA; CAHB; CFHC; CBAA; CBAB; CFFB; CGLA; CGLB; CAAA; CAAB; CAAC; CBAB; CBAC; CBBA; CBBB; CBDA; CBDB; CBDC; CFJA; CFWA; CJCA; CJCB; CJAA; CCHA; CEGA

CODE	€/Pz
FG 192/VW10	320,00

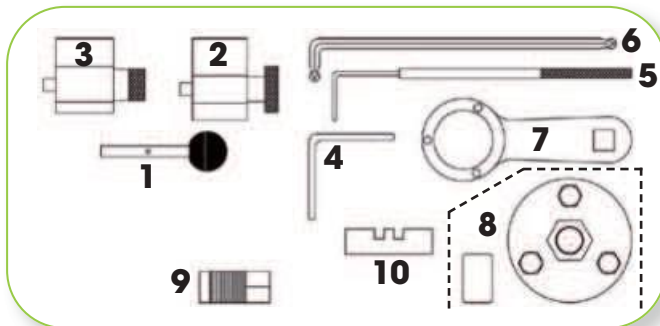

CODE	DESCRIPTION	€/Pz
1: FG 192/FO24-14	Injection pump/balancer shaft locking pin	14,20
2: FG 192/VW10-2	Crankshaft sprocket locking tool	38,00
3: FG 192/VW10-3	Crankshaft sprocket locking tool	27,00
4: FG 192/VW7-4	Auxiliary drive belt tensioner locking pin (3.9 mm)	10,00
5: FG 192/VW10-5	Tensioner pulley locking tool	15,00
6: FG 192/VW10-6	Tensioner pulley adjusting tool	15,00
7: FG 192/VW10-7	Camshaft sprocket hub holding tool	70,00
8: FG 192/VW10-8	Camshaft sprocket hub puller	82,00
9: FG 192/VW10-9	Camshaft sprocket hub puller	19,00
10: FG 192/VW10-10	Balancer shaft locking tool	15,00

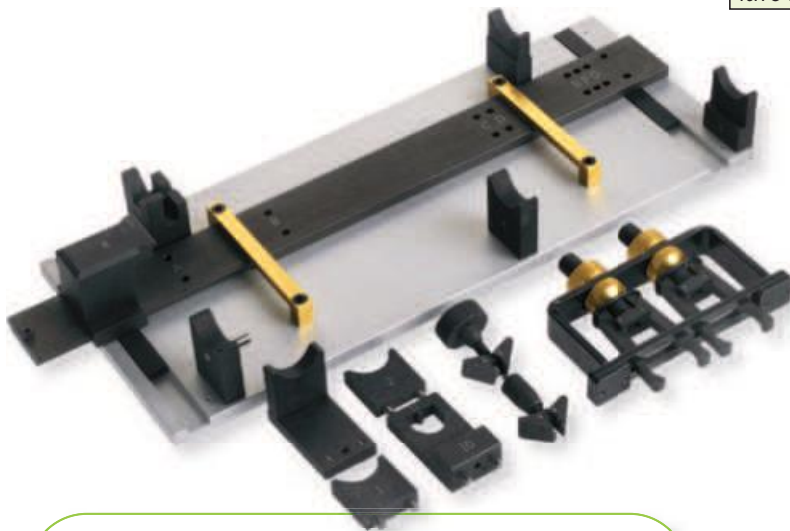

## Camshaft/Head Rebuild set for VAG engines (Timing gears in cylinder head) for VW, AUDI, SEAT, SKODA 1.6, 2.0 TDI CR

CODE	€/Pz
FG 192/VW11	1.600,00

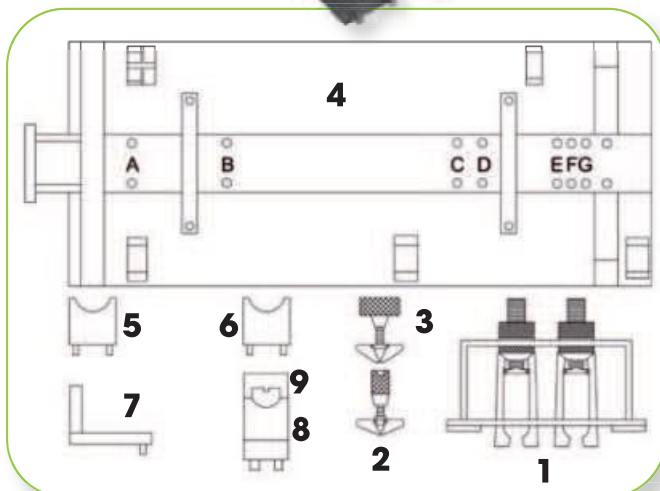

CODE	DESCRIPTION	€/Pz
1: FG 192/VW11-1	Camshaft locking pin	270,00
2: FG 192/VW11-2	Two-piece exhaust camshaft gear alignment tool	91,00
3: FG 192/VW11-3	Two-piece exhaust camshaft gear alignment tool	100,00
4: FG 192/VW11-4	Base plate of camshaft fitting tool	930,00
5: FG 192/VW11-5	Support for camshaft alignment tool	36,00
6: FG 192/VW11-6	Support for camshaft alignment tool	35,00
7: FG 192/VW11-7	Support for camshaft alignment tool	65,00
8: FG 192/VW11-8	Support for camshaft alignment tool	75,00
9: FG 192/VW11-9	Support for camshaft alignment tool	75,00



### Timing tool set VOLKSWAGEN 2.4, 2.5 TDI



**Models:**  
LT; Crafter; Transporter T4

**Engine:** 2.4, 2.5 Tdi  
**Engine codes:** ANJ; BJJ; BJK; BJL; BJM; AAB; AJA

CODE	€/Pz
FG 192/VW7B	185,00

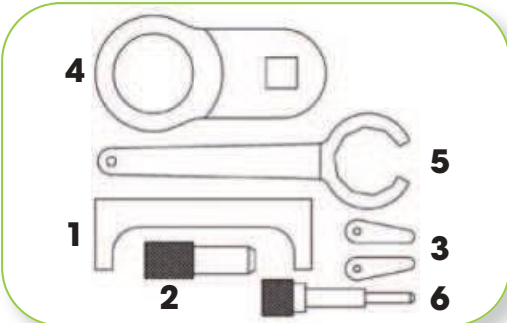

CODE	DESCRIPTION	€/Pz
1: FG 192/FO24-13	Camshaft setting bar	8,10
2: FG 192/FO24-12	Injection pump sprocket locking pin (Ø15.4 mm)	8,10
3: FG 192/FO24-8	Shims	12,90
4: FG 192/VW7B-4	Crankshaft pulley holding tool	94,90
5: FG 192/VW7B-5	Tensioner pulley spanner	57,60
6: FG 192/VW7B-6	Crankshaft timing pin	16,90



### Timing tool set VAG 2.5 TDi V6



**Models:**  
*Volkswagen:* Passat  
*Audi:* A4; A4 quattro; A6; A6 quattro; A8; Allroad; A4 Cabrio  
*Skoda:* Superb

**Engine:** 2.5 Tdi  
**Engine codes:** AFB; BAU; AKE; AKN; BDG; BDH; AFB; BAU; AKE; AKN; AYM; BCZ; BDG; BDH; BFC; AYM; BDG

CODE	€/Pz
FG 192/VW9	165,00

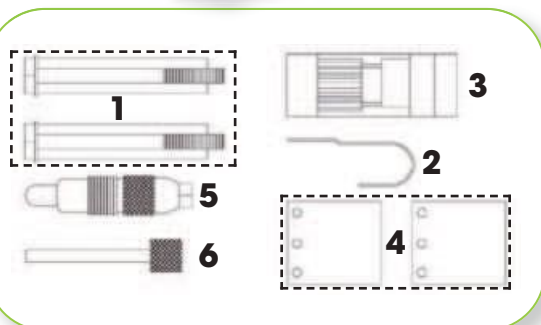

CODE	DESCRIPTION	€/Pz
1: FG 192/VW9-1	Support guides (2 pcs)	55,00
2: FG 192/VW9-2	Tensioner locking pin	2,00
3: FG 192/VW9-3	Tensioner wrench	36,00
4: FG 192/VW9-4	Camshaft alignment tool (2 pcs)	20,00
5: FG 192/VW9-5	Crankshaft locking tool	13,00
6: FG 192/VW14-9	Injection pump locking pin	7,80





### Timing tool set VOLKSWAGEN 2.5 TDI PD



**Models:**  
Transporter, Touareg

**Engine:** 2.5 TDI PD  
**Engine codes:** AXD; AXE; BAC; BLJ;  
BLK; BNZ; BPC; BPD; BPE

CODE	€/Pz
FG 192/VW6	530,00

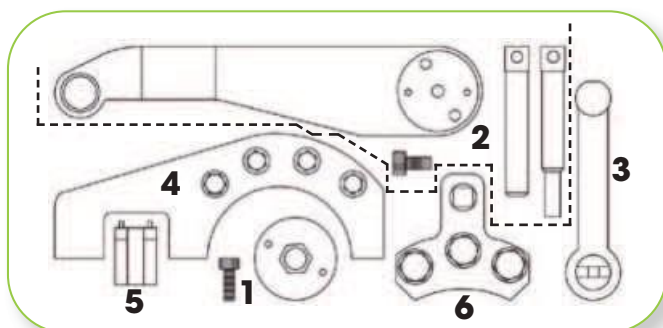

CODE	DESCRIPTION	€/Pz
1: FG 192/VW6-1	Crankshaft alignment tool	22,40
2: FG 192/VW6-2	Crankshaft locking tool	100,70
3: FG 192/VW6-3	Camshaft alignment tool	22,40
4: FG 192/VW6-4	Camshaft gear locking tool	209,70
5: FG 192/VW6-5	Camshaft compensation gear pre-tensioning tool	41,90
6: FG 192/VW6-6	Camshaft gear holding / turning tool	106,30



### Water pump removal set for VOLKSWAGEN 2.5 TDI PD



**Models:**  
Transporter, Transporter T5, Touareg

**Engine:** 2,5 TDI PD  
**Engine codes:** AXD, AXE, BAC, BLJ, BLK, BNZ, BPC, BPD

CODE	€/Pz
FG 192/VW6B	195,00

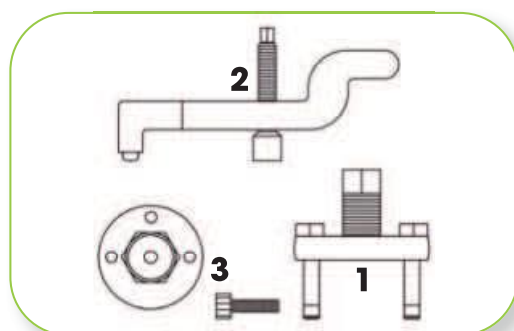

CODE	DESCRIPTION	€/Pz
1: FG 192/VW6B-1	Gear Puller (For removing gear from coolant pump)	65,00
2: FG 192/VW6B-2	Water pump puller	107,00
3: FG 192/VW6B-3	Crankshaft alignment tool	48,00



### Crankshaft pulley holding tool suitable for VOLVO DIESEL



**Models:**

C30, C70, S40, V50, C30 D5, C70 D5, S60, V70, XC70 Turbo

**Engine:** 2.0 D, 2.3 D, 2.4D, 2.5D, 2.8D, 2.9D

**Engine codes:** D5244T9, D5244T8, D5244T7, D5244T6, D5244T5, D5244T4, D5244T3, D5244T2, D5244T19, D5244T18, D5244T17, D5244T16, D5244T15, D5244T13, D5244T11, D5244T10, D5244T, D5204T7, B6304S3, B6294T, B6294S2, B6294S, B5254T7, B5254T8, B5254T3, B5254T2, B5254T11, B5254T10, B5244T7, B5244SG2, B5244SG, B5244S7, B5244S5, B5234T9, B5234T8, B5234T7, B5234T3, B5204T5, B5204T4, B5204T3

CODE	€/Pz
FG 192/VO1	102,00

### Timing tool set VAG/PORSCHE 2.5, 2.8, 3.2 FSI e 3.0 TFSI



**Models:**

*PORSCHE:* Cayenne, Panamera

*Volkswagen:* Touareg

*AUDI:* A4, A5, A6, A7, A8, Q5, Q7, S4, S5, SQ5

**Engine:** 2.5 FSI; 2.8 FSI; 3.2 FSI; 3.0 TFSI; 3.0 Hybrid S; 3.0 TSI Hybrid

**Engine codes:**

*PORSCHE:* M06/EC; CGEA

*Volkswagen:* CGFA; CJTA; CGEA

*AUDI:* CREA; CREC; CRED; CHMB; CGWD; CGXB; CHMA; CTTA; CTUA; CTVA; CTWA; CTWB; CGWC; CXTA; CTUD; CALA; BDX; CCDA; CCEA; CALB;



CODE	€/Pz
FG 192/VW5C	275,00

### Timing tool set VW/AUDI 2.7D, 3.0D TDi V6, 4.0D, 4.2D TDi V8 (Timing chain)



**Models:**

*AUDI:* A4, A4 Cabrio, A6, A6 allroad, A5 Coupe/Cabriolet, A5 Sportback, A8, Q7, Q5, A5 Coupe/Cabriolet

**Engines:** 2.7TDI, 2.7TDI CR, 3.0TDI, 3.0TDI CR, 4.0TDI CR, 4.2TDI CR

**Engine code:** BPP, BSG, CAMA, CAMB, CANA, CANB, CANS, CAND, CGKA, CGKB, ASB, BKN, BMK, BMZ, BNG, BUG, CAPA: CASA, CASB, CCLA, CCMA, CCWA, CCWB, CDTA, CDTB, CDUC, CDYA, CDYB, CDYC, CJGA, CJGC, CKVB, CKVC, CLAA, CLAB, CLZB, ASE, BVN, CDSB, CCFA, BTR CLAA, CLAB, CLZB, ASE, BVN, CDSB, CCFA, BTR



CODE	€/Pz
FG 192/VW12	330,00

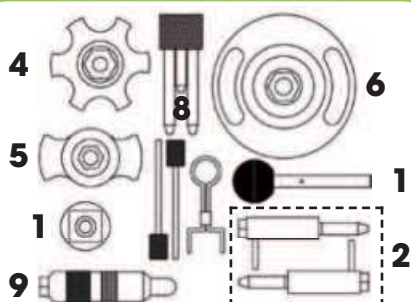

CODE	DESCRIPTION	€/Pz
1: FG 192/VW12-1	Crankshaft turning tool (TYPE 1)	17,80
2: FG 192/VW12-2	Camshaft locking pin (2 pcs)	21,40
3: FG 192/VW12-3	Chain tensioner piston locking pin (Ø3.3mm) - (2pcs)	14,20
4: FG 192/VW12-4	Camshaft holding/alignment tool	60,50
5: FG 192/VW12-5	Camshaft sprocket holding tool	71,20
6: FG 192/VW12-6	Crankshaft turning tool (TYPE 2)	71,20
7: FG 192/VW12-7	Timing chain tensioner locking pin (3 pcs)	21,40
8: FG 192/VW12-8	High-pressure fuel pump sprocket locking tool	26,70
9: FG 192/VW14-8	Crankshaft locking tool	15,60
10: FG 192/FO24-14	Balancer shaft/high-pressure fuel pump locking tool	14,20







## High pressure pump sprocket removers for Hyundai/Kia



### Model:

**Hyundai:** Matrix; Accent/Excel; Getz; i10; Elantra; i30; i20; ix35; ix20; i40; i20 Coupe; Tucson

**Kia:** Cerato; Rio; Picanto; Cee'd; Pro-Cee'd; Soul; Venga; Sportage; Carens; Optima

**Engine:** 1.1 CRDi; 1.4 CRDi; 1.5 CRDi; 1.6 CRDi; 1.7 CRDi

**Engine code:** D3FF; D3FA; D4FC; D4FA; D4FB-H (U2); D4FB-L (U2); D4FB-H (U1); D4FB

CODE	€/Pz
FG 192/HI7	195,00

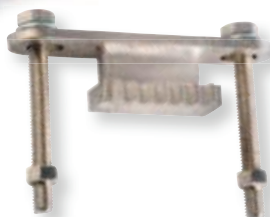

## Flywheel locking tool for Hyundai / Kia

CODE	€/Pz
FG 192/HI7B	90,00



## High pressure pump sprocket remover for Hyundai/Kia

### Model:

**Hyundai:** Tucson, ix35, Grand Santa Fe, Santa Fe

**Kia:** Sorento, Sedona, Carnival, Sportage

**Engine:** 2.0 CRDi, 2.2 CRDi

**ENGINE CODE:** D4HA; D4HA-H; D4HA-L; D4HB

CODE	€/Pz
FG 192/HI1	95,00



## Flywheel locking tool for Hyundai / Kia

**HYUNDAI:** Accent; Elantra; Genesis Coupe; Grand Santa Fe; H1/H300; i10; i20; i30; i40; i800; ix20; ix35; Santa Fe; Sonata; Sonica; Tucson; Tiburon

**KIA:** Venga; Sportage; Sorento; Soul; Rio; Pro-Cee'd; Picanto; Optima; Carens

**Engine:** 1.0; 1.2; 1.25; 1.4; 1.6; 2.0; 2.2; 2.4; 2.7

**ENGINE CODE:** G3LA; B3LA; G3LC; G4LA; G4; G4LA; G4LC; G4FA; G4FA-L; G4FC; G4FC-GL; G4FDG4FJ; G4KD; G4KF; G4NC; G4NA; G4ND; G4NE; DAHA-H; D4HA-L; D4HA; D4HB; G4KE; G4KJ; G6BA

CODE	€/Pz
FG 192/HI2	128,00



CODE	€/Pz
FG 192/HO5	95,00

## Timing tools for Honda 1.6-3.0 SOHC/DOHC

**MODEL:** Civic; Accord; Prulde; Shuttle; Odyssey

**ENGINE:** 1.6, 1.8, 2.0, 2.2; 2.3; 3.0

**Engine code:**

**1.6:** B16A2

**1.8:** F18A3, F18B2, F18B4

**2.0:** F20AF, F20B3, F20B5, F20B6, F20B7, F20Z1, F22Z2, F22B5, F22B8, F22A2, H22A5, H22A7, H22A8

**2.3:** F23A7, F23Z5, H23A2, H23A3

**3.0:** J30A1



CODE	€/Pz
FG 192/DW2	102,00

## Water pump wrenches 41mm for Chevrolet, Daewoo



### Model:

**Chevrolet:** Aveo, Cruze, Kalos, Lacetti, Nubira, Tacuma/Rezzo,

**Daewoo:** Kalos, Lacetti, Lanos, Nexia/Cielo/Racer, Nubira, Tacuma/Rezzo

**Engine:** 1.4, 1.5, 1.6, 1.8

**Engine code:** F14D3, F16D3, A16DMS, G15MF, A15MF, F14S3, A15DM, A15SMS, A16DM, F18N



CODE	€/Pz
FG 192/HI5	60,00

## Belt tensioner tools for Hyundai, Mitsubishi e Proton



### Model:

**Hyundai:** Lantra/Elantra; Sonata; Santa Fe; Trajet

**Mitsubishi:** 3000 GT; Colt; Lancer; Carisma; Space Star; Pajero Pinin; Galant; Space runner; Grandis; Triton

**Proton:** Persona; 418; Satria; Wira; M21 Coupe

**Engine:** 1.6, 1.8, 2.0, 2.4, 3.0, 3.5

**Engine code:**

**1.6:** 4G61, G4-R - **1.8:** 4G67, 4G93, 4G93P, G4-N

**2.0:** 4G63, 4G94, G4CP, G4JP, G4-P - **2.4:** 4G64, 4G69, G4JS

**3.0:** 6G72 - **3.5:** 6G74



## Timing tools for Toyota, Lexus



### Model:

**Toyota:** 4-Runner, Auris, Avensis, Camry, Celica, Corolla, Corolla Verso/CombiVan, Dyna, Hiace, Hilux, Landcruiser, Landcruiser/Prado, MR2, Picnic/SportVan, Previa, Prius, RAV4, Starlet, Tarago, Verso, Verso/Sportsvan, Vienta, Yaris

**Lexus:** GS, IS, LS, LX, RX, SC

### Engine:

1.0, 1.3, 1.4, 1.6, 2.0, 2.2, 2.4, 2.5, 2.7, 2.8, 3.0, 3.4, 3.5, 4.7

### Engine code:

1SZ-FE, 2SZ-FE, 4G15, 4G93, 2ZR-FAE, 1ZZ-FE, 2AD-FHV, 2AD-FTV, 1AD-FTV, 1CD-FTV, 1MZ-FE, 4E-FE, 2L, 3ZZ-FE, 4ZZ-FE, 3L, 2TR-FE, 2KD-FTV, 2L-T, 1GR-FE, 5VZ-FE, 5L, 2ZR-FE

CODE	€/Pz
FG 192/TY45	610,00

CODE	DESCRIPTION	€/Pz
1: FG 192/TY45-1	M8x55 screws for FG 192/TY45-21 (2 pcs)	2,00
2: FG 192/TY45-2	Crankshaft pulley puller	64,00
3: FG 192/TY45-3	Arm for FG 192/TY45-2 (2 pcs)	42,50
4: FG 192/TY45-4	L:100 mm central screw for FG 192/TY45-2	12,50
5: FG 192/TY45-5	L:150 mm central screw for FG 192/TY45-2	15,00
6: FG 192/TY45-6	M5x100 leg (2 pcs)	20,00
7: FG 192/TY45-7	M8x50 leg (2 pcs)	12,50
8: FG 192/TY45-8	M8x100 leg (2 pcs)	17,50
9: FG 192/TY45-9	M8x150 leg (2 pcs)	22,50
10: FG 192/TY45-10	M6x30 leg (2 pcs)	10,00
11: FG 192/TY45-11	M6x100 leg (2 pcs)	20,00
12: FG 192/TY45-12	M8x75 leg (2 pcs)	15,00
13: FG 192/TY45-13	M8x225 leg (2 pcs)	25,00
14: FG 192/TY45-14	M10x1.25 adaptors (2 pcs)	9,00
15: FG 192/TY45-15	M10x1.5 adaptors (2 pcs)	9,00
16: FG 192/TY45-16	M12x1.25 adaptors (2 pcs)	9,00
17: FG 192/TY45-17	M12x1.5 adaptors (2 pcs)	9,00
18: FG 192/TY45-18	Adaptor	4,00
19: FG 192/TY45-19	Crankshaft pulley puller	106,00
20: FG 192/TY45-20	M8x65 screws for FG 192/TY45-19 puller (2 pcs)	2,00
21: FG 192/TY45-21	Crankshaft pulley puller	106,00
22: FG 192/TY45-22	M8x106 screws for FG 192/TY45-21 puller (2 pcs)	6,50
23: FG 192/TY45-23	M8x116 screws for FG 192/TY45-21 puller (2 pcs)	4,50
24: FG 192/TY45-24	M6x80 screws for FG 192/TY45-21 puller (2 pcs)	2,00
25: FG 192/TY45-25	M8x88 screws for FG 192/TY45-21 puller (2 pcs)	6,50
26: FG 192/TY45-26	Universal handle	55,00

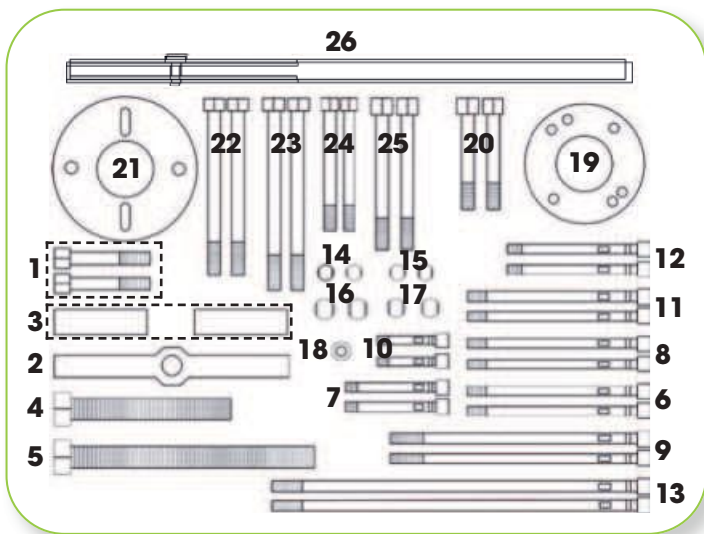

## Camshaft pulley and Crankshaft pulley holder for Toyota and Lexus



### Model:

**Lexus:** GS; LS; LX; RX

**Toyota:** Auris; Avensis; Corolla; Aygo; Celica; Corolla Verso/CombiVan

### Engine:

1.0; 1.3; 1.4; 1.6; 2.0; 2.2; 2.4; 2.5; 2.7; 2.8; 3.0; 3.4; 3.5; 4.7

### Engine code:

1UZ-FE; 1MZ-FE; 3MZ-FE; 3UZ-FE; 4ZZ-FE; 1CD-FTV; 1ZZ-FE; 3ZZ-FE; 2ZZ-GE; 2KD-FTV; 2KD-FTV H; 2KD-FTV L; 1KD-FTV; 2UZ-FE; 2SZ-FE

CODE	€/Pz
FG 192/TY15	175,00



## NEW 2023 ENGINE TIMING TOOLS

**Timing tool set suitable for petrol BMW engines - M42, M52, M50, M43**

**MODELS:** SERIE 3; SERIE 5; SERIE 7; Z3

**ENGINE:** 2.0; 2.5; 2.8

**ENGINE CODES:** M42; M43; M50; M52

CODE	€/Pz
FG 192/BW10	420,00

NEW

**Timing tool set suitable for petrol BMW engines - M52, M54**

**MODELS:** SERIE 3; SERIE 5; SERIE 7; X3; X5; Z3; Z4

**ENGINE:** 2.0; 2.2; 2.5; 2.8; 3.0

**ENGINE CODES:** M52; M54

CODE	€/Pz
FG 192/BW11	650,00

NEW

**Timing tool set suitable for petrol BMW engines - N51, N52, N53, N54, N55**

**MODELS:** Serie 1; Serie 2; Serie 3; Serie 4; Serie 5; Serie 6; Serie 7; X1; X3; X4; X5; X6; Z4

**ENGINE:** 2.5; 3.0

**ENGINE CODES:** N51; N52; N53; N54; N55

CODE	€/Pz
FG 192/BW19	835,00

NEW

## NEW 2023 ENGINE TIMING TOOLS



**Timing tool set suitable  
for 2.2 diesel Alfa Romeo engines**



**MODELS:** Alfa Romeo: Stelvio; Giulia  
**ENGINE:** 2.2  
**ENGINE CODES:** 55284529

CODE	€/Pz
FG 192/AF5	110,00

**NEW**



**Timing tool set suitable for petrol  
1.0 Fiat/Jeep engines**



**MODELS:** FIAT: 500X (2018-2022)  
JEEP: Renegade (2018-2022)  
**ENGINE:** 1.0  
**ENGINE CODES:** 55282151

CODE	€/Pz
FG 192/FT8	165,00

**NEW**

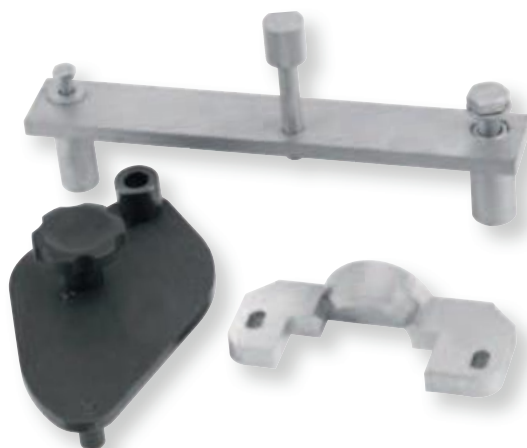

**Timing tool set suitable for 1,0  
petrol FIAT engines**



**MODELS:** 500; 500C; PANDA  
**ENGINE:** 1.0 benzina  
**ENGINE CODES:** 46341162

CODE	€/Pz
FG 192/FT8C	430,00

**NEW**





### Timing tool set suitable for 1.2 Ti-VCT petrol FORD engines



**MODELS:** KA+ (2018-2020)

**ENGINE:** 1.2 Ti-VCT

**ENGINE CODES:** B1KE; ENAP; ENB1

CODE	€/Pz
FG 192/FO2	200,00

NEW



### Timing tool set suitable for 1.5 ECOBOOST petrol FORD engines



**MODELS:** FIESTA; FOCUS; KUGA (2018-2022)

**ENGINE:** 1.5 ECOBOOST benzina

**ENGINE CODES:** Y1DA; YZDA; Y2DA; YZJA

CODE	€/Pz
FG 192/FO16C	290,00

NEW



### Crankshaft trigger wheel installer suitable for Land Rover / Jaguar diesel engines



**APPLICATIONS:** Land Rover (Discovery 3 & 4; Range Rover Sport); Jaguar (X200 S TYPE; X250 XF; X350 XJ; X351 XJ)

CODE	€/Pz
FG 192/LRF	220,00

NEW



### Timing tool set suitable for TD V8 Diesel Land Rover engines



**MODELS:** RANGE ROVER; RANGE ROVER SPORT  
**ENGINE:** 3.6 TD V8  
**ENGINE CODE:** 368DT

CODE	€/Pz
FG 192/LR13	450,00

**NEW**



### PSA 1.2 Petrol engine timing set (Wet Belt)



**MODELS:** C1 (2015-2018); C3 Aircross (dal 2016); Berlingo (dal 2018); C4 Cactus (dal 2014); C5 Aircross (dal 2019); DS4 (2014-2019); DS3 (dal 2016); DS7 (dal 2018); 208 (dal 2014); 308 (dal 2014); 508 (dal 2019); 2008 (dal 2013); 3008 (dal 2014); 5008 (dal 2014)

**ENGINE:** 1.2  
**ENGINE CODE:** EB2

CODE	€/Pz
FG 192/PS5	270,00

**NEW**



### Camshaft adjuster control valve removal tool set for VAG engines



**MODELS:** AUDI: A3; A4; A5 Cabriolet; A5 Coupe; Q5  
**VOLKSWAGEN:** Passat  
**ENGINE CODES:** BYT; BZB; CABA; CABB; CBFA; CAWB; CDAA; CDAB

CODE	€/Pz
FG 192/VW8E	105,00

**NEW**





### Camshaft sprocket puller suitable for VAG / PORSCHE engines



**MODELS:** A6; A5; A8; Q5; Q7; Touareg; CAYENNE

**ENGINE:** 2.7; 3.0

**ENGINE CODES:** PORSCHE: M05/9E; M05/9D (CAS)

VAG: BMK; CARA; CEXA; BKS; BUN; CASA; CASB; CASC; CATA; CANA; BPP; CCWA; CCWB

CODE	€/Pz
FG 192/VW12A	70,00

NEW



### Timing tool set suitable for M48 Porsche engines



**MODEL:** CAYENNE

**ENGINE:** 4.5 e 4.8

**ENGINE CODES:** 4.5: M48/00; M48/50; M48/50S; M48/50T 4.8: M48/01G; M48/01; M48/51; M48/51S; M48/51T

CODE	€/Pz
FG 192/PR8	850,00

NEW



### Timing tool set suitable for VAG / Porsche petrol 6 and 8 cylinder FSI engines



**MODELS:** VAG: TOUAREG; PASSAT; BORA; GOLF; Q7; A8; S8; A3

PORSCHE: CAYENNE

**ENGINE:** PORSCHE: 3.6

VAG: 2.8 ~ 6.3 benzina

**ENGINE CODES:** M55/1; M55/2

CODE	€/Pz
FG 192/PR5	360,00

NEW



### Timing tool set suitable for M96 and M97 Porsche petrol engines



**MODELS:** 911 (2001-2008); BOXSTER (2002-2011); CAYMAN (2006-2009)

**ENGINE:** 2.7, 3.2, 3.4, 3.6, 3.8

**ENGINE CODES:** M96/03; M96/05; M96/23; M96/25; M96/24; M96/26; M97/01; M97/20; M97/21; M97/22

CODE	€/Pz
FG 192/PR4	220,00

**NEW**



### Timing tool set suitable for M96 Porsche petrol engines



**ENGINE:** 2.5 BENZINA; 3.2 benzina; 3.4 benzina

**ENGINE CODES:** M96/01; M96/01S; M96/20; M96/2

CODE	€/Pz
FG 192/PR6	120,00

**NEW**



### Timing tool set suitable for Volvo 2.0 diesel engines



**MODELS:** VOLVO: S60 II ; V40 ; V90 II; XC60; XC40; XC70; XC90

**ENGINE:** 2.0 DIESEL

**ENGINE CODES:** D4204T...

CODE	€/Pz
FG 192/VO3	230,00

**NEW**





**Dial gauge**

CODE	Range	Resolution	€/Pz
FG 192/CO	0-8mm	0.01mm	<b>102,00</b>



**Pulley puller wrench**

CODE	€/Pz
FG 184/CP	<b>75,00</b>

14 mm

400mm



**Dial gauge holder**

CODE	M	L1/mm	L/mm	€/Pz
FG 192/PM	14x1.25	43	230	<b>82,00</b>



**Removing/installing tool for stretch belts**

CODE	€/Pz
FG 192/CE	<b>78,00</b>



**SPECIAL FITTINGS FOR AUTOMATIC TRANSMISSION OIL**



**- BMW, Volvo, Audi, Mercedes-Benz, Renault, SAAB, Ford**

**Application:**  
09D; 0C8; AF33-5; AF40;  
AISIN TR60-SN; O9E;  
AW55-50SN; TR-60SN;  
722.9; ZF6HP

CODE	€/Pz
FG 193/R1	<b>175,00</b>



**- BMW, Volvo, Audi, Mercedes-Benz, Renault, SAAB, Ford**

**Application:**  
09D; 0C8; AF33-5; AF40;  
AISIN TR60-SN; O9E;  
AW55-50SN; TR-60SN;  
722.9; ZF6HP

CODE	€/Pz
FG 193/R2	<b>175,00</b>



**- AUDI, VW, Jeep**

**Application:**  
ZF5HP; OB5;  
O9L; OAW;  
A500; O1V

CODE	€/Pz
FG 193/R3	<b>42,00</b>

**- Jeep, Mitsubishi, GM, Suzuki, Toyota**

**Application:**  
ZF

CODE	€/Pz
FG 193/R5	<b>18,00</b>



**- Audi, Porsche, Opel, Subaru, Mazda, Citroen, Renault, Alfa, Lancia**

**Application:**  
AW55-50SN;  
AF40; TF-81SC;  
ZF5HP; 6L80;  
6L90; TF-80SC;  
AF21; TF-80SD

CODE	€/Pz
FG 193/R4	<b>46,00</b>



**- Audi, Volkswagen, Porsche, Lexus, Mitsubishi**

**Application:**  
O9G; TF-60SN;  
O9M; ZF5HP;  
TF-63SN

CODE	€/Pz
FG 193/R6	<b>35,00</b>



**- Jeep, Fiat, Chrysler,  
Mercedes-Benz, Subaru**

**Application:**

4L60E; 4L65E;  
41TE; 41AE; 62TE;  
WFC280; 5EAT

CODE	€/Pz
FG 193/R7	24,00



**- Jaguar, Mercedes-Benz,  
Ssangyong**

**Application:**

722.6; 722.3;  
722.4; 722.7

CODE	€/Pz
FG 193/R9	30,00



**- Audi, Mercedes-Benz,  
Mitsubishi**

**Application:**

R4A51; V4A51;  
V5A51; 42RE;  
44RE; 45RFE;  
5-45RFE; 722.6;  
722.9

CODE	€/Pz
FG 193/R8	35,00



**- Jaguar, Mercedes-Benz,  
Mitsubishi, Ssangyong**

**Application:**

722.6; 722.3;  
722.4; 722.7

CODE	€/Pz
FG 193/R10	35,00



**- Jaguar, Ford, Mazda**

**Application:**

5R55E; 5R55S;  
5R55N; 5R55W

CODE	€/Pz
FG 193/R11	24,00



**- VW, Audi, Mitsubishi**

**Application:**

O9E; O9L;  
ZF6HP

CODE	€/Pz
FG 193/R13	46,00



**- Volvo XC60, V60**

**Application:**

AISIN con valvola  
termostatica

CODE	€/Pz
FG 193/R12	95,00



**- Volvo**

**Application:**

42RE; 44RE; 45RFE;  
A500; 5-45RFE

CODE	€/Pz
FG 193/R13B	46,00



**- Ford, Jeep, Dodge**

**Application:**

ZF9HP (9SP)

CODE	€/Pz
FG 193/R14	52,00



**- Mercedes-Benz e Renault DCT**

**Application:**

K7A240; K7A350;  
K7X350; 7DCT300

CODE	€/Pz
FG 193/R16	88,00

**- Hyundai, Toyota, Kia,  
Mitsubishi, Isuzu**

**Application:**

A340; A340E; A340H; A341E; A343F;  
AW 30-40LE; AW30-40LS; A5HF1;  
F5A51; F5AH1; F4A42 /B; TZ10

CODE	€/Pz
FG 193/R15	30,00



**- Jeep**

**Application:**

45RFE; 5-45RFE

CODE	€/Pz
FG 193/R17	30,00



**- Jeep, FIAT, Alfa Romeo,  
Opel, Citroen**

**Application:**

AF33-5; 09G; 09M;  
TF-80SC (AF40);  
TF-80SD (AF40)

CODE	€/Pz
FG 193/R18	86,00



**- Audi, VW, Seat, Skoda DSG**

**Application:**

DQ250 (02E);  
DQ500 (0BH)

CODE	€/Pz
FG 193/R20	125,00



**Fiat, PSA, Renault**

**Application:**

AL4; DP0

CODE	€/Pz
FG 193/R19	95,00



**- Renault, Mitsubishi, Nissan**

**Application:**

JF613E; RE0F06A

CODE	€/Pz
FG 193/R21	116,00





**- Mitsubishi**

**Application:**  
R4A51;  
R5A51

CODE	€/Pz
FG 193/R22	58,00



**- GM**

**Application:**  
42RE; 44RE; 45RFE;  
A500; 5-45RFE

CODE	€/Pz
FG 193/R23	46,00



**- Fiat, JEEP, Land-Rover**

**Application:**  
ZF09HP

CODE	€/Pz
FG 193/R26	170,00



**- Toyota, Suzuki, Mazda**

**Application:**  
K410-411

CODE	€/Pz
FG 193/R27	135,00



**- Jeep Grand Cherokee, Alfa Stelvio**

**Application:**  
8HP70

CODE	€/Pz
FG 193/R30	128,00



**- Audi, BMW, Jaguar, Land-Rover, Alfa Romeo, Jeep, Iveco**

**Application:**  
ZF8HP45; ZF8HP50;  
ZF8HP55; ZF8HP55AF;  
ZF8HP65A; ZF8HP70;  
ZF8HP90; ZF8HP75H

CODE	€/Pz
FG 193/R31	82,00



**- Jeep, Dodge, Opel**

**Application:**  
42RE; 44RE; 45RFE;  
A500; 5-45RFE

CODE	€/Pz
FG 193/R24	28,00



**- Ford, Renault, Peugeot, Volvo**

**Application:**  
6DCT250;  
6DCT450/WD;  
6DCT451; DD

CODE	€/Pz
FG 193/R25	105,00



**- Fiat, JEEP, Land-Rover**

**Application:**  
OB5; OAW; O8HP

CODE	€/Pz
FG 193/R28	70,00

**NEW**



**- BMW, MINI, VOLVO, PSA**

**Application:**

AWF8F45 (BMW/MINI); TG-81 (VOLVO); AT8-AT6 (PSA)

CODE		€/Pz
FG 193/R32		138,00
FG 193/R42		105,00
FG 193/R44		105,00
FG 193/R45		105,00
FG 193/R46		105,00
FG 193/R47		105,00
FG 193/R48		105,00



**Set of universal plates**

CODE	€/Pz
FG 193/R34	93,00



**- CITROEN, PEUGEOT**

**Application:**  
TF-71; TF-81

CODE	€/Pz
FG 193/R36	105,00



**Set of universal extensions  
(Ø 10, 13, 15mm)**

CODE	€/Pz
FG 193/R35	58,00



**- Fiat, GM, Ford, Jeep,  
Chrysler, Saab, Mercedes**

**Application:**  
722.9 7G Tronic

CODE	€/Pz
FG 193/R37	65,00



**- AUDI**

**Application:**  
ZF5HP; OB5; O9L;  
0AW; A500; O1V

CODE	€/Pz
FG 193/R29	46,00

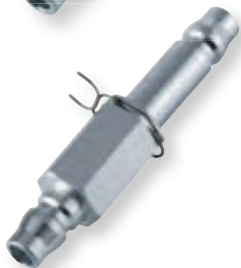

**- Bmw, Jaguar**

**Application:**  
ZF 6HP

CODE	€/Pz
FG 193/R38	65,00



**- Mercedes CLK-C, AMG**

**Application:**  
722.6 6 Marce

CODE	€/Pz
FG 193/R39	65,00



**- GM**

**Application:**  
42RE; 44RE; 45RFE;  
A500; 5-45RFE

CODE	€/Pz
FG 193/R33	46,00



**- PSA, VW, Fiat Ducato**

**Application:**  
ZF 4HP20

CODE	€/Pz
FG 193/R40	65,00



**- Bmw**

**Application:**  
TG-81

CODE	€/Pz
FG 193/R41	70,00



**Kit of 19 standard special fittings**

CODE	€/Pz
FG 193/S19	1.280,00



**Kit of 10 optional special fittings**

CODE	€/Pz
FG 193/S10	1.050,00



**Content:**

- FG 193/R1    - FG 193/R7    - FG 193/R13    - FG 193/R24
- FG 193/R2    - FG 193/R8    - FG 193/R14    - FG 193/R31
- FG 193/R3    - FG 193/R9    - FG 193/R15    - FG 193/R34
- FG 193/R4    - FG 193/R10    - FG 193/R18    - FG 193/R35
- FG 193/R6    - FG 193/R11    - FG 193/R20

**Content:**

- FG 193/R16    - FG 193/R25
- FG 193/R17    - FG 193/R26
- FG 193/R19    - FG 193/R27
- FG 193/R21    - FG 193/R28
- FG 193/R22    - FG 193/R32



**Mounting/Dismounting tools for automatic transmissions 0AW MULTITRONIC**

CODE	€/Pz
FG 193/AT1	1.350,00



*Secondary shaft pulley puller*

CODE	€/Pz
FG 193/AT1-1	250,00



*Mounting tool for sprocket-wheel axle*

CODE	€/Pz
FG 193/AT1-2	95,00



*Puller for sprocket-wheel axle*

CODE	€/Pz
FG 193/AT1-3	95,00



*Clutch shaft puller*

CODE	€/Pz
FG 193/AT1-4	380,00



*Socket wrench for secondary bolt*

CODE	€/Pz
FG 193/AT1-5	225,00

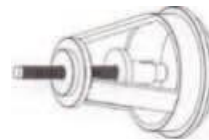

*Mounting tool for double seal*

CODE	€/Pz
FG 193/AT1-6	140,00



*Sensor puller*

CODE	€/Pz
FG 193/AT1-7	90,00



**Shaft holder for automatic transmission 0AW MULTITRONIC**

CODE	€/Pz
FG 193/AT1-8	600,00

**Mounting/Dismounting tools for automatic transmissions 722.6**

CODE	€/Pz
FG 193/AT2	750,00



*Bearing's extractor from water's pump stator*

CODE	€/Pz
FG 193/AT2-1	180,00



*Mounting tool for stator's water pump bearing*

CODE	€/Pz
FG 193/AT2-2	75,00



*Piston's spring extractor for B1 Clutch group*

CODE	€/Pz
FG 193/AT2-3	70,00



*Piston's spring extractor for B2&K3 group*

CODE	€/Pz
FG 193/AT2-4	55,00



*Piston's extractor for K2 group*

CODE	€/Pz
FG 193/AT2-5	55,00



*Piston's extractor for K1 group*

CODE	€/Pz
FG 193/AT2-6	60,00



*Mounting tool for water pump bush*

CODE	€/Pz
FG 193/AT2-7	30,00
FG 193/AT2-8	30,00



**Planetary shaft holder for automatic transmission 722.6**

CODE	€/Pz
FG 193/AT2-9	250,00

## Mounting/Dismounting tools for automatic transmissions 722.8

CODE	€/Pz
FG 193/AT3	980,00

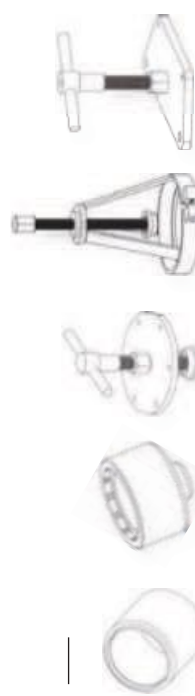

Primary shaft pulley puller

CODE	€/Pz
FG 193/AT3-1	120,00

Secondary shaft pulley puller

CODE	€/Pz
FG 193/AT3-2	230,00

Secondary shaft pulley puller

CODE	€/Pz
FG 193/AT3-3	195,00

Socket wrench for secondary shaft nut

CODE	€/Pz
FG 193/AT3-4	190,00

Holder for secondary shaft bearing

CODE	€/Pz
FG 193/AT3-5	80,00

## Mounting/Dismounting tools for automatic transmissions 01J MULTITRONIC

CODE	€/Pz
FG 193/AT4	1.250,00

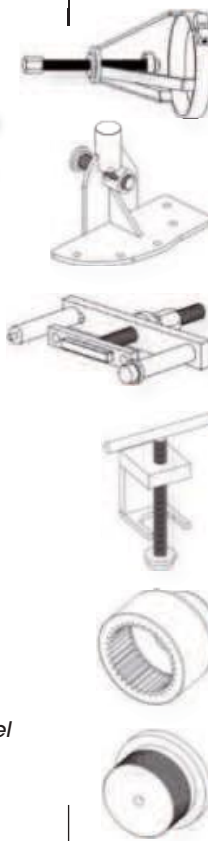

Secondary shaft pulley puller

CODE	€/Pz
FG 193/AT4-1	250,00

Secondary shaft sprocket-wheel pulley puller

CODE	€/Pz
FG 193/AT4-2	230,00

Joint puller

CODE	€/Pz
FG 193/AT4-3	200,00

Primary shaft sensor pulley puller

CODE	€/Pz
FG 193/AT4-4	110,00

Chiave a bussola per dado albero secondario

CODE	€/Pz
FG 193/AT4-5	225,00

Socket wrench for secondary shaft nut

CODE	€/Pz
FG 193/AT4-6	65,00

Seal bush

CODE	€/Pz
FG 193/AT4-7	80,00

Seal bush for secondary shaft sprocket-wheel

CODE	€/Pz
FG 193/AT4-8	85,00

## Kit of spring compressor for automatic transmissions

CODE	€/Pz
FG 193/UN	1.050,00



CODE	SIZE	€/Pz
FG 193/UN-1	100x169H	66,00
FG 193/UN-2	62x161H	55,00
FG 193/UN-3	70x323H	77,00
FG 193/UN-4	80x168H	60,50
FG 193/UN-5	105x123H	60,50
FG 193/UN-6	105x161H	66,00
FG 193/UN-7	113x168H	66,00
FG 193/UN-8	111x201H	71,50
FG 193/UN-9	111x122H	66,00
FG 193/UN-10	98x123H	71,50
FG 193/UN-11	90x161H	66,00



CODE	€/Pz
FG 193/UN-12	130,00





**Mounting and dismantling tool for DCT clutch group**

CODE	€/Pz
FG 193/DCT	160,00



**Oil dipstick for automatic transmission**

CODE	APPLICATION	€/Pz
FG 193/DS1	Mercedes 722.6	35,00
FG 193/DS2	Mercedes 722.7, 722.8, 716.S	35,00

**Tool holder for DSG clutch group**

CODE	€/Pz
FG 194/TS	30,00



**ATF fill plug wrench Jaguar/Land Rover**

CODE	€/Pz
FG 193/ATJ	45,00



**Oil drain set for Mercedes 9G Tronic**

CODE	€/Pz
FG 193/MB	65,00



**Bearings puller set for manual transmission gear box - VAG group**

CODE	€/Pz
FG 193/S4	590,00



**Set of 9 tools for removing, installing and adjusting 7-gear DSG clutches**

CODE	€/Pz
FG 193DSG/S9	1.050,00



**Set of 6 tools for removing, installing 7gear DSG clutches**

CODE	€/Pz
FG 193DSG/S6	695,00



**Hammer with round face and pein**

CODE	mm	€/Pz
FG 130/TP	40	38,00

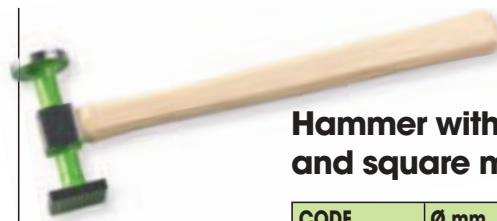

**Hammer with round flat and square milled faces**

CODE	Ø mm	□/mm	€/Pz
FG 130/TZQ	40	38mm	46,00



**Hammer with round and square faces**

CODE	Ø mm	□/mm	€/Pz
FG 130/TQ	40	38mm	44,00



**Hammer with round flat face and point pein**

CODE	Ø mm	€/Pz
FG 130/TPP	40	40,00



**Universal dolly**

CODE	SIZE	€/Pz
FG 131/TR	70x62x64mm	46,00



**Toe dolly**

CODE	SIZE	€/Pz
FG 131/TC	30x120x58mm	46,00



**Curved dolly**

CODE	SIZE	€/Pz
FG 131/TV	59x130x40mm	46,00

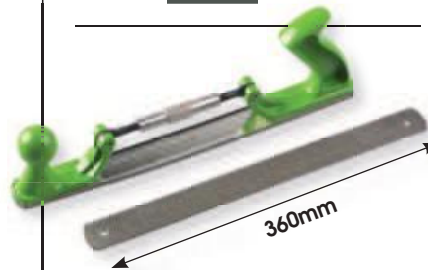

**Blade holder with radial flat blade**

CODE	BLADE	€/Pz
FG 131/PL9	9"	112,00
FG 131/PL12	12"	118,00



**Heel dolly**

CODE	SIZE	€/Pz
FG 131/TB	30x78x60mm	42,00

**Flat radial blade**

CODE	BLADE	€/Pz
FG 131/PL9R	9"	56,00
FG 131/PL12R	12"	62,00

**Blade holder**

CODE	€/Pz
FG 131/PL	56,00



**Curved angle spoon - light model**

CODE	L/mm	€/Pz
FG 131/SC	290	58,00



**Double ended spoon**

CODE	L/mm	€/Pz
FG 131/SCP	420	88,00



**Flat angle spoon - light model**

CODE	L/mm	€/Pz
FG 131/SCZ	260	50,00



**Long double ended spoon**

CODE	L/mm	€/Pz
FG 131/SCG	520	108,00







### Set 10 tools for car body repair shops

CODE	€/Pz
FG 130/S10	580,00



FG 131/TR

FG 131/TB

FG 131/TC

FG 131/TV

FG 131/SC

FG 131/SCZ

FG 130/TQ

FG 130/TPP

FG 136/30

FG 131/PL12



### Aluminium tap down tool kit

Content:  
01 adjustable tap down 70mm-100mm Thread M8x1.25  
04 non-scratch tips

CODE	€/Pz
FG 130AL/S5	35,00



### Set of 3pcs plastic scraper tools

Material: High resistance polypropilene

CODE	€/Pz
FG 184P/S3	25,00



### Set of 3pcs steel scrapers with ABS handle

Total lenght: 280mm

CODE	€/Pz
FG 184R/S3	45,00



### Steel scrapers with ABS handle

Total lenght: 280mm

CODE	€/Pz
FG 184/R1	20,00



### Steel scraper with pvc protection and ABS handle

Total lenght: 275mm

CODE	€/Pz
FG 184/R2	22,00



### Set of 4pcs trim removal tools

Material: Nylon and fiber glass.  
High resistance to torsion  
Equipped with hanging hook

CODE	€/Pz
FG 185P/S4	25,00



### Molding strip wedge set

Material: Nylon and fiber glass.  
High resistance to torsion  
Equipped with hanging hook

CODE	€/Pz
FG 188P/S2	40,00



### Universal hook tool

Material: Nylon and fiber glass.  
High resistance to torsion  
Equipped with hanging hook

CODE	€/Pz
FG 188/P1	18,00



### Set 11 nylon tools for car body repair shops

CODE	€/Pz
FG 186/S11	115,00

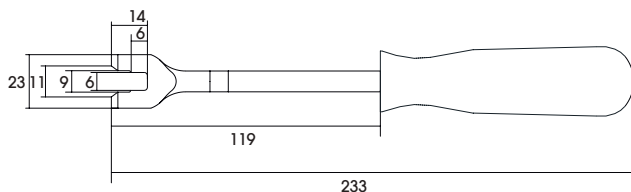

### Clip removal tool

CODE	€/Pz
FG 185/A1	20,00

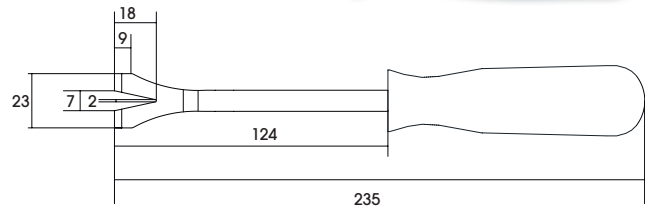

### Clip removal tool

CODE	€/Pz
FG 185/A2	20,00

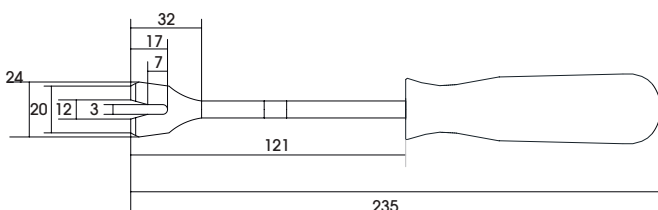

### Clip removal tool

CODE	€/Pz
FG 185/A3	17,00

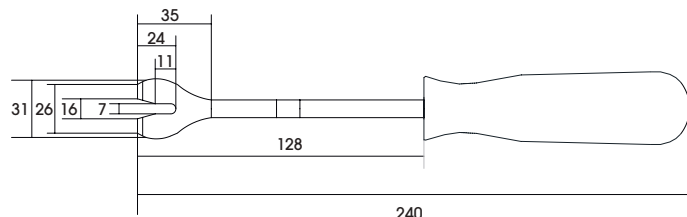

### Clip removal tool

CODE	€/Pz
FG 185/A4	18,00



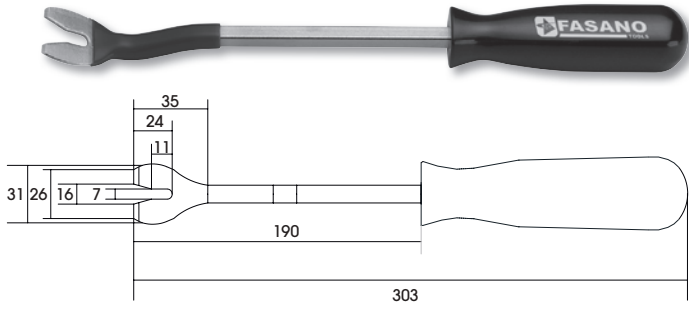

**Clip removal tool**

CODE	€/Pz
FG 185/A5	20,00

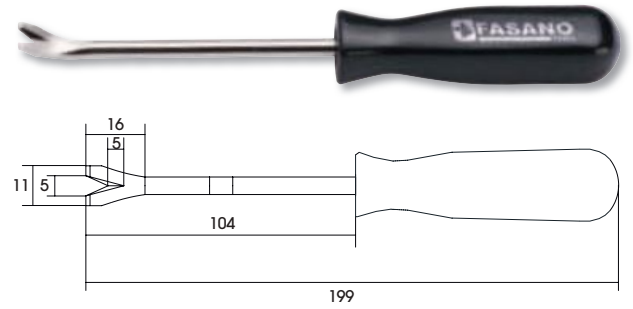

**Clip removal tool**

CODE	€/Pz
FG 185/A6	16,00

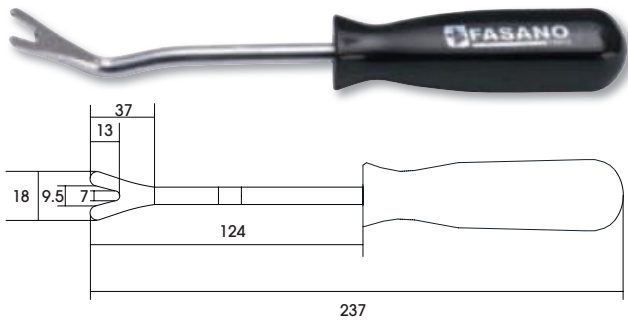

**Clip removal tool**

CODE	€/Pz
FG 185/A7	20,00

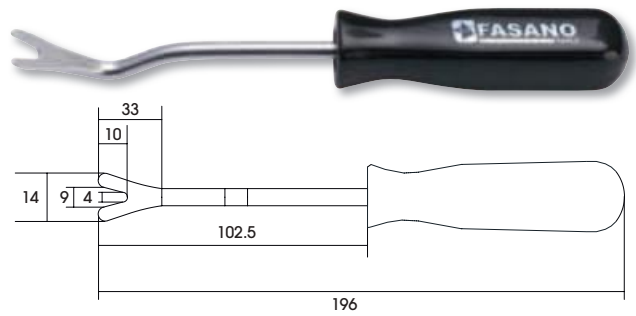

**Clip removal tool**

CODE	€/Pz
FG 185/A8	18,00



**Set of 5pcs clip removal tools**

Content: 185/A1, FG 185/A2, FG 185/A6, FG 185/A7, FG 185/A8

CODE	€/Pz
FG 185/S5	95,00



**Set of 2pcs clip removal tools**

CODE	€/Pz
FG 185B/S2	40,00

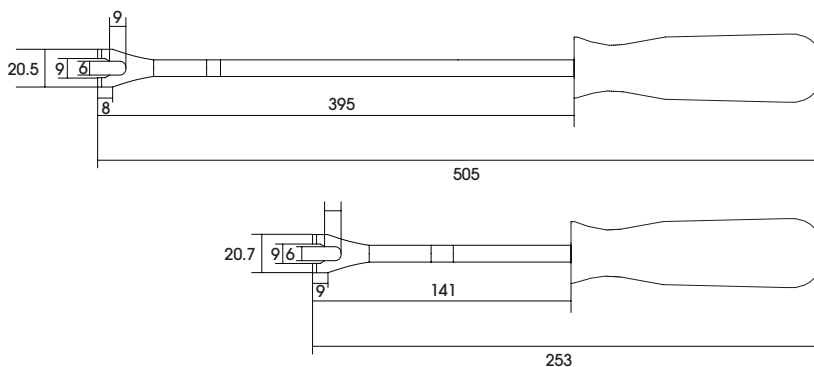

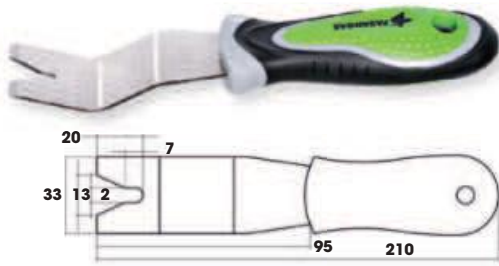

**Trim pin  
remover**

CODE	€/Pz
FG 186/A1	21,00



**Trim pin  
remover**

CODE	€/Pz
FG 186/A2	21,00

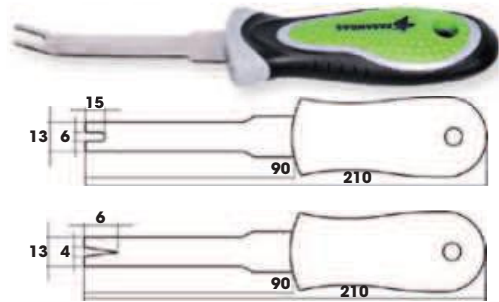

**Trim pin  
remover**

CODE	€/Pz
FG 186/A3	17,50
FG 186/A4	16,50

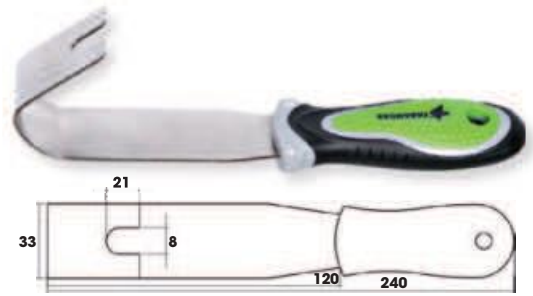

**Trim pin  
remover**

CODE	€/Pz
FG 186/A5	24,00



**Set of 5 trim pin  
removers, stainless  
steel blade**

CODE	€/Pz
FG 186/S5	95,00



**Set of 5pcs Nylon  
trim pin removers**

CODE	€/Pz
FG 186P/S5	36,00

**Trim pin  
removal pliers**

CODE	€/Pz
FG 186/LP	35,00



**Plastic prying/  
Smoothing tools kit**

CODE	€/Pz
FG 186/S3	9,60



**Plastic O-ring  
removal tool kit**

CODE	€/Pz
FG 186/S3B	11,20

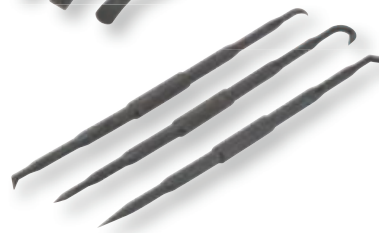



**Roof grab handle removal tool**

Total length: 255mm  
ABS handle

CODE	€/Pz
FG 185/RM	30,00



**C-clip removal tool**

Ideal for removing the C-springs present on the window lifter cranks

CODE	€/Pz
FG 185/CR	10,00



**Cylinder removal tool door locks - VAG Group**

CODE	€/Pz
FG 189/PO1	20,00



L/mm

**Glass run channel cleaner**

Ideal for cleaning the window lifter channel  
Spherical tip to avoid damage to the door guides

CODE	L/mm	€/Pz
FG 182/RG10	255mm	18,00
FG 182/RG24	320mm	25,00



200

**Glass seal removal tool**

Total length: 252mm  
ABS handle

CODE	€/Pz
FG 183/RV1	20,00



**Razor scraper with straight blade**

Supplied with a blade ABS handle with hole for hanging  
Equipped with ABS blade protection

CODE	€/Pz
FG 183/RA1	25,00



**Set of 10pcs razor scraper blade**

CODE	€/Pz
FG 183RA/S10	12,00



### Manual knife equipped with cable and cable stop system

PVC coated handle and cable  
Supplied with a pre-mounted 25mm blade

CODE	€/Pz
FG 183/CM	50,00



### Set of 3pcs blades for FG 183/CM

- 19, 25, 38mm

CODE	L/mm	€/Pz
FG 183CM/S3	19,25,38mm	24,00

### Individual knife blade for FG 183/CM

CODE	L/mm	€/Pz
FG 183/CM19	19mm	8,00
FG 183/CM25	25mm	8,00
FG 183/CM38	38mm	8,00



### Cutting knife

Supplied with a blade  
PVC coated handle  
Screw blade locking system

CODE	SIZE	€/Pz
FG 183/CK250	250mm	21,00
FG 183/CK450	450mm	32,00
FG 183/CK600	600mm	40,00

Set of 10pcs blades  
for FG 183/CK

CODE	€/Pz
FG 183/CK-R	10,00



### Locking strip tool

Equipped with 6 accessories  
Roller guide system  
ABS handle

CODE	€/Pz
FG 187/GR	28,00



### Lever for car window

CODE	€/Pz
FG 187/GU	28,00



### T-Handle wire starter tool

CODE	€/Pz
FG 187/GU2	25,00





**Set of 2pcs wire handles**

CODE	€/Pz
FG 187/IM	40,00



**Windscreen cutting wires - square section**

CODE	LENGHT	SECTION	€/Pz
FG 187/W50	50 Metri	0.8mm	34,00



**Windscreen cutting wires - triangle section**

CODE	LENGHT	SECTION	€/Pz
FG 187/WT22.5	22.5 Metri	0.6mm	25,00



**Windscreen cutting wires - intertwined section**

CODE	LENGHT	SECTION	€/Pz
FG 187/IW50	50 Metri	0.8mm	30,00



**Windscreen Nylon cutting wires - intertwined section**

CODE	LENGHT	SECTION	€/Pz
FG 187/NY	50 Metri	0.85mm	60,00



**Suction cup - capacity 25Kg**

CODE	€/Pz
FG 187/K25	42,00

117mm



**Suction cups for car glasses - capacity 10Kg**

CODE	€/Pz
FG 187/K10	23,00

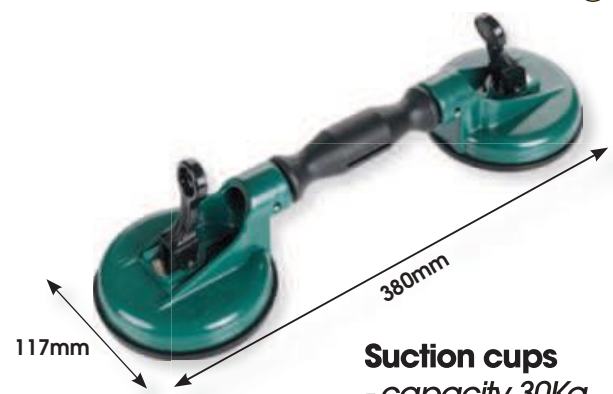

**Suction cups - capacity 30Kg**

CODE	€/Pz
FG 187/K30	70,00

117mm

380mm



**Suction cup with handle and pump system**  
- Diameter: 178mm - 7"  
- Capacity: 40Kg

CODE	€/Pz
FG 187/K40	190,00





**Suction cup**  
- Capacity: 130Kg  
- Useful for truck and bus  
- Supplied in ABS box

CODE	€/Pz
FG 187/K130	280,00



**Set of 7 tools  
for car glasses**

CODE	€/Pz
FG 187/S7	210,00

**Set of 6pcs suction cups**  
Diameter: 78mm - 3"  
Capacity: 10Kg

CODE	€/Pz
FG 187K/S6	55,00

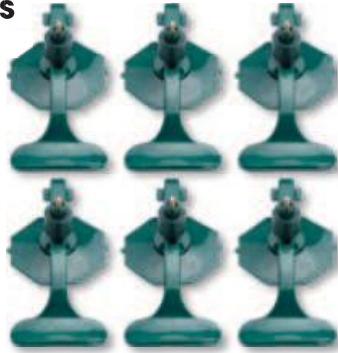

**Vacuum dent puller,  
with 3 suction cups**

CODE	€/Pz
FG 187/PN	255,00



**Vacuum dent puller,  
with 3 suction cups**

CODE	€/Pz
FG 187/TB	235,00



**Angle screwdriver**

CODE	€/Pz
FG 186/AS	40,00



**Windshield  
wiper arm remover**

CODE	Ø/mm	€/Pz
FG 165/BC1	30-50	45,00



**Windshield  
wiper arm remover**

CODE	Ø/mm	€/Pz
FG 165/BC2	30-57	42,00





24mm



**Engine crankshaft rotator DAF**

**Engine codes:**  
65CF, 75CF, 85CF, 95XF,  
CF75, CF85, F65, F75, F85,  
F95, XF95F95, XF95

CODE	€/Pz
FG 197/DA1	88,00

1/2"



**Engine crankshaft rotator DAF**

**Engine:** XF105 Euro5

CODE	€/Pz
FG 197/DA2	68,00

1/2"



**Engine crankshaft rotator MAN**

**Engine codes:**  
D20..., D25..., D26..., D28...

CODE	€/Pz
FG 197/MA1	88,00

1/2"



**Engine crankshaft rotator SCANIA**

**Engine codes:**  
SCANIA (dopo il 1996)

CODE	€/Pz
FG 197/SC1	66,00



**Engine crankshaft rotator VOLVO**

**Engine codes:**  
D9A, D12, D16C

CODE	€/Pz
FG 197/VO1	88,00

1/2"  
46mm



**Engine crankshaft rotator VOLVO and RENAULT**

**Models:**  
HGV Volvo, RENAULT  
**Engine codes:**  
MP8, MP10 (FH, D13A520)

CODE	€/Pz
FG 197/VO2	77,00

**Engine crankshaft rotator IVECO**

**- double gear**  
**Engine:** 8040.25.45,  
8060.25.45, 8260, 8210.42,  
8280, 8460, 190.38, 190.42

CODE	€/Pz
FG 197/IV1	240,00



**Engine crankshaft rotator IVECO**

**- double gear**  
**Engine:** 8360.46, F3A, F3B

CODE	€/Pz
FG 197/IV2	242,00



**Engine crankshaft rotator Mercedes Benz and MAN**

**- double gear**  
**Models:** Merceder-Benz 6,8,10 Cil.  
MAN 12 cilindri  
**Engine codes:**  
401, 404, 407, 409, 421, 424, 444, 427, 447

CODE	€/Pz
FG 197/MB1	90,00

1/2"



**Engine crankshaft rotator Mercedes Benz and MAN**

**- triple gear**  
**Models:**  
Merceder-Benz Actros e Atego;  
MAN 5, 6, 8 cilindri

CODE	€/Pz
FG 197/MB2	120,00

1/2"



**Set utensili per centraggio frizioni**

**Coni di centraggio:**  
- Ø 36-45mm  
- Ø 42-52mm

CODE	€/Pz
FG 180/S6	200,00

**Chiave per filtri essiccatori**

CODE	€/Pz
FG 197/F1	49,00
FG 197/F2	27,00

-FG 197/F1: Ø 120-140mm  
-FG 197/F2: -Ø 125-145mm





**Octagonal impact socket for locking hub nuts**

CODE	Ø mm	DRIVE	€/Pz
FG 194/A80	80	41mm	175,00
FG 194/A95	95	3/4"	175,00
FG 194/A100	100	3/4"	175,00
FG 194/A109	109	41mm	185,00
FG 194/A115	115	3/4"	198,00
FG 194/A120	120	41mm	210,00



**Impact socket for BPW locking hub nuts**

CODE	Ø mm	DRIVE	€/Pz
FG 194/A85	85	3/4"	175,00
FG 194/A105	105	1"	180,00



**Impact socket for BPW locking hub nuts**

CODE	Ø mm	DRIVE	€/Pz
FG 194/B96	96	3/4"	175,00
FG 194/B111	111	41mm	210,00



**Impact socket for BPW locking hub nuts**

CODE	Ø mm	DRIVE	€/Pz
FG 194/B65	65	3/4"	95,00
FG 194/B80	80	3/4"	120,00



**Impact socket for BPW locking hub nuts**

CODE	Ø mm	DRIVE	€/Pz
FG 195/A110	110	36mm	305,00



**Impact socket for leaf spring**

CODE	Ø mm	DRIVE	€/Pz
FG 196/A37	37x28	3/4"	50,00
FG 196/A46	46x34	3/4"	55,00
FG 196/A56	56x34	3/4"	66,00



**Impact socket for BPW locking hub nuts**

CODE	Ø mm	DRIVE	€/Pz
FG 195/A95	95	36mm	310,00
FG 195/A98	98	36mm	310,00



**Impact socket for leaf spring - VOLVO**

CODE	Ø mm	€/Pz
FG 196/AV	27mm	30,00



**Impact socket for rectangular nuts**

CODE	AxB mm	€/Pz
FG 195/R56	56 x 71	90,00
FG 195/R60	60 x 76	90,00

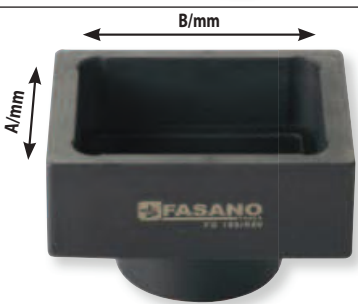

MERCEDES, DAF, MAN

**Ball joint puller**

CODE	€/Pz
FG 197/BP	330,00





FASANO TOOLS

Twin Power 1.4

# 12

**GENERAL MAINTENANCE**



**Grease gun**

- Usable with cartridge or bulk grase
- Endowed with rigid and flexible hoses

CODE	CAPACITY	L SPOT	€/Pz
FG 490/C500	500CC	320mm	45,00
FG 490/C800	800CC	500mm	55,00
FG 490/C1000	1.000CC	500mm	56,00

∅ inner: 53mm

**Coupler with 4 jaws**

CODE	€/Pz
FG 490/TE	3,00

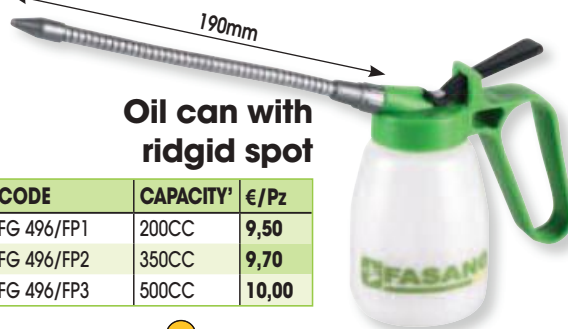
**Oil can with rigid spot**

CODE	CAPACITY'	€/Pz
FG 496/FP1	200CC	9,50
FG 496/FP2	350CC	9,70
FG 496/FP3	500CC	10,00

**Oil can with flexible spot**

CODE	CAPACITY'	L SPOT	€/Pz
FG 495/FA1	200CC	14.5	9,50
FG 495/FA2	350CC	14.5	9,80
FG 495/FA3	500CC	14.5	10,20

**Grease gun - push type**

- Usable with cartridge or bulk grase
- Supplied with 4 jaws nozzle and pointed nozzle

CODE	€/Pz
FG 490/PT	15,00

**Oil gun**

- Capacity: 500CC
- L/mm hose: 260

CODE	€/Pz
FG 491	20,00

**Oil can with retractable rigid spot**

CODE	CAPACITY'	SPOT	€/Pz
FG 497/OP1	30CC	10-165mm	6,30
FG 497/OP2	80CC	110-175mm	7,40
FG 497/OP3	150CC	150-240mm	7,60

**Oil can with polyethylene retractable spot**

CODE	CAPACITA'	CANNUCCIA	€/Pz
FG 497/SP1	125CC	150mm	8,20
FG 497/SP2	250CC	180mm	9,00

**Oiler pen**

CODE	CAPACITY	€/Pz
FG 497	5CC	11,60



**Bonding gun with metal body**

- Equipped with DRIP-LESS function



CODE	CAPACITY	€/Pz
FG 493/N	300CC	38,50



**Bonding gun with aluminum body**

CODE	CAPACITY	L/mm	L/mm tubo	€/Pz
FG 493/AL	300CC	440	240	45,00
FG 493/AL2	400CC	480	280	46,00
FG 493/AL3	600CC	580	380	55,00



**Set of 4pcs putties with stainless steel blades**

CODE	€/Pz
FG 47/S4	21,50



**Glue gun kit**

- Supplier with 12 glue sticks

CODE	€/Pz
FG 494/S12	55,00



- Rated heating power: 80W
- Working temperature: 193°C (383°F)
- Working temperature: 3/5 min
- Length of glue stick: 200mm
- Diameter of glue stick: 11.5mm



**Set of 3pcs putty knife scrapers**

CODE	€/Pz
FG 47/S3	58,00



**Straight putty knife scraper**

CODE	€/Pz
FG 47/P1	18,50



**Bent putty knife scraper**

CODE	€/Pz
FG 47/P2	18,50



**Straight putty knife scraper**

CODE	€/Pz
FG 47/P3	18,50



**Professional glue gun**

CODE	€/Pz
FG 494/A180	165,00



- Rated heating power: 80W
- Working temperature: 193°C (383°F)
- Working temperature: 3/5 min
- Length of glue stick: 100,250,350mm
- Diameter of glue stick: 11/11.5mm



Professional vice  
- forged steel

CODE	L/mm	A/mm	€/Pz
FG 121/B100	100	125	275,00
FG 121/B125	125	150	365,00
FG 121/B150	150	200	465,00
FG 121/B175	175	220	700,00

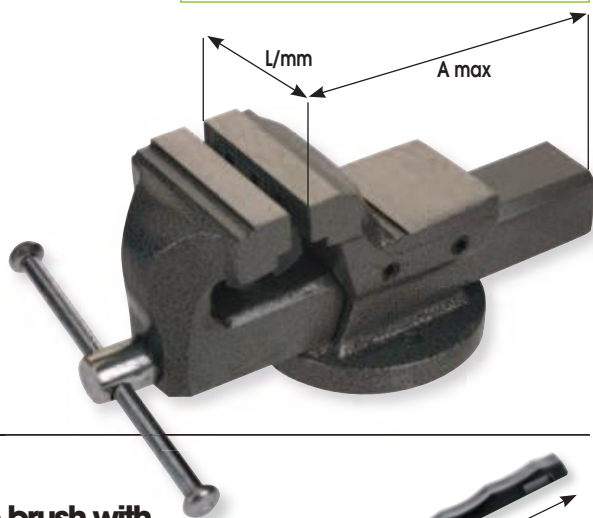

Wire brush with  
brass wires

CODICE	€/Pz
FG 79/SP	4,00



Wire brush with  
brass wires

CODICE	€/Pz
FG 79/SP2	9,00

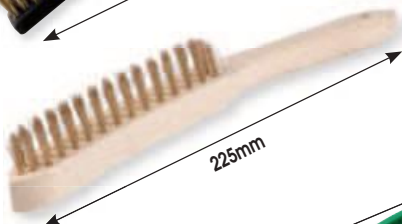

Wire brush with  
brass wires

CODICE	€/Pz
FG 79/SP4	5,00



NEW

Pry bar with  
flat curved ends

CODE	L/mm	€/Pz
FG 125/A1	300	14,00
FG 125/A2	450	20,00
FG 125/A3	600	24,50



Set 3pcs  
pry bars

CODE	€/Pz
FG 125/S3	65,00



Carpenter's wrenching bar

CODE	L/mm	€/Pz
FG 125/L500	500	21,00
FG 125/L700	700	27,00



Wire brush with  
steel wires

CODE	€/Pz
FG 79/SP3	5,20



Riveting pliers with 4  
interchangeable heads

CODE	€/Pz
FG 260	75,00



Ø/mm	2.4 (3/32")	3.0/3.2 (1/8")	4.0 (5/32")	4.8/5.0 (3/16")	5.0
Aluminum	X	X	X	X	X
Steel	X	X	X	X	X
INOX	X	X	X	X	X

Riveting pliers with 5  
interchangeable heads

CODE	€/Pz
FG 260/GP	185,00



Ø/mm	2.4 (3/32")	3.0/3.2 (1/8")	4.0 (5/32")	4.8/5.0 (3/16")	6.4
Aluminum	X	X	X	X	X
Steel	X	X	X	X	X
INOX	X	X	X	X	



**Riveting pliers for plastic rivets**

CODE	€/Pz
FG 260/RP	60,00



**Set of 10pcs plastic rivits**

CODE	SIZE	€/Pz
FG 260PR/S1	5x15.8mm	6,50
FG 260PR/S2	5x17.2mm	7,50
FG 260PR/S3	6.3x17.2mm	7,50
FG 260PR/S4	6.3x25.2mm	9,00

**Riveting pliers for threaded rivets with 4 heads**

CODE	€/Pz
FG 261	130,00



Ø/mm	M3x0.5	M4x0.7	M5x0.8	M6x1.0
Aluminum	X	X	X	X
Steel	X	X	X	X
INOX	X	X	X	

**Magnetic and flexible pickup tool**

- capacity: 3.5Kg

CODICE	€/Pz
FG 92/PF	25,00

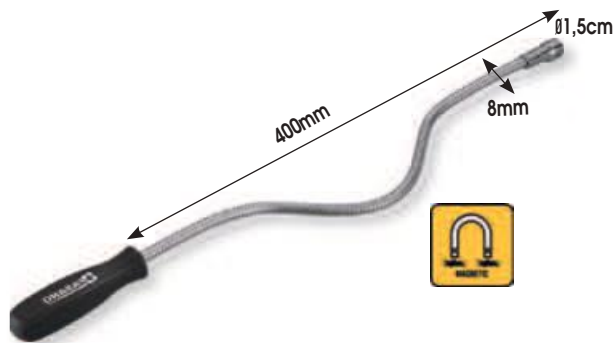

**Telescopic inspection mirror**

CODE	€/Pz
FG 93/M50	30,00

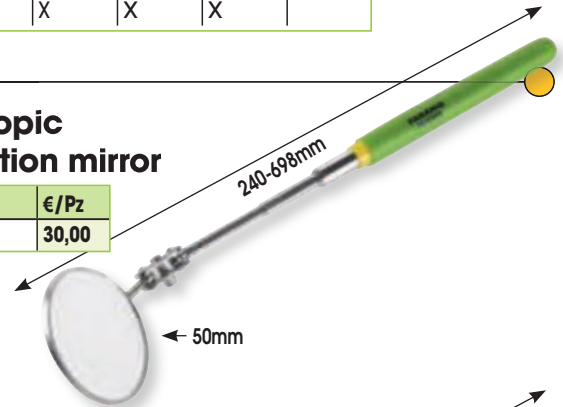

**Telescopic inspection mirror**

CODE	€/Pz
FG 93/M95	30,00

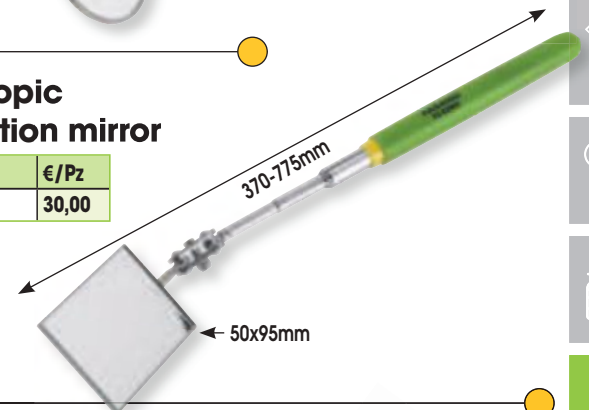

**Magnetic pick-up tool**

- capacity: 0.6Kg

CODE	€/Pz
FG 92/PM1	10,50



**Magnetic pick-up tool**

- capacity: 2.3Kg  
- grip in double anti-slip PVC

CODE	€/Pz
FG 92/PM4	27,50



**Magnetic pick-up tool**

Dipstick's length: 1meter  
Ø: 3.9mm

CODE	€/Pz
FG 92/PM	19,00

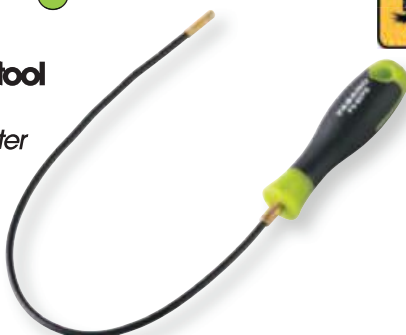

**Magnetic pick-up tool**

- capacity 1Kg / - Length: 700mm

CODE	€/Pz
FG 92/GR	26,50

with gripping jaws





**Soldering gun 100W**

- MAX TEMPERATURE: 570°C
- VOLT: 230
- SUPPLIED WITH 1 TIP AND WIRE POOL
- CLASS OF PROTECTION: II

CODE	€/Pz
FG 95/SP100	65,00



- TIP (FG 95/TIP1): 6,00 Euro

**Soldering iron - dual power**

CODE	Watt	Volt	Ø/mm	€/Pz
FG 96/SS36	30/60	230V	5.8	62,00

- CLASS OF PROTECTION: I



- TIPS (FG 96/TIP2): 6,00 Euro

**Wire pool**

- Set of 3pcs

CODE	Ø mm	€/Pz
FG 98/STA	1.0	12,00

**Desoldering pump with anti-static nozzle**

CODE	€/Pz
FG 98/SS	12,00

**Anti-static nozzle**

CODE	€/Pz
FG 98/AS	3,00

**Soldering iron**

CODE	Watt	Volt	Ø/mm	°C	€/Pz
FG 96/SS30	30	230V	4	430	48,00
FG 96/SS60	60	230V	6	500	62,00

- CLASS OF PROTECTION: I

**TIPS:**

CODE	FOR:	€/Pz
FG 96/TIP1	FG 96/SS30	7,00
FG 96/TIP2	FG 96/SS60	7,00

**Portable gas soldering iron**

CODE	Watt	°C	€/Pz
FG 98/GAS	25-80	210 - 400	120,00

- Autonomy: 120minutes
- Supplied with 4 tips: soldering, hot knife, blow torch, heat blower
- Capacity: 21 ml

**TIPS:**

CODE	FUNZIONE:	€/Pz
FG 98/TIP1	SALDATURA	16,50
FG 98/TIP2	TAGLIO	16,50
FG 98/TIP3	FIAMMA	16,50
FG 98/TIP4	SOFFIO	16,50

**Mini USB soldering iron**

CODE	Watt	Volt	€/Pz
FG 98/ST8	8	5	16,50

- Max temperature: 480 °C

**Mini USB plastic cutter**

CODE	Watt	Volt	€/Pz
FG 98/PC8	8	5	16,50

- Max temperature: 400 °C



### Portable Li-Ion battery soldering iron

- MAX TEMPERATURE: 600°C
- CAPACITY: 40MIN CONTINUOUSLY
- RECHARGE TIME: 3.5H
- SUPPLIER 2 3 TIPS FOR SOLDERING CUTTING AND BLOWING

CODE	€/Pz
FG 98/LT	170,00



### Parts container with revolving compartments

CODE	€/Pz
FG 712/L4	120,00

- 4 rotating compartments
- upper fixed tray for small parts
- compartments equipped with removable dividers
- 3 ABS support feet



### Small parts / tools holder equipped with swivel wheels

- Equipped with 2 magnetic compartments for small parts
- Equipped with 2 large tool holders
- Equipped with magnetic central plate
- 3 swivel wheels of 500mm
- Material: impact resistant ABS

CODE	€/Pz
FG 712/A	50,00



300 LUMEN

Rechargeable cob led lamp

CODE	€/Pz
FG 207	65,00



Top led



360 LUMEN

Rechargeable cob led lamp

CODE	€/Pz
FG 206	55,00

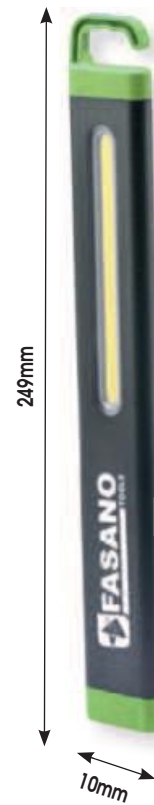

EXTRA-FLAT

1.200 LUMEN



Under the hood rechargeable cob led

CODE	€/Pz
FG 208	230,00



Adjustable length:  
1.300-2.060mm



Portable lamp  
integrated and removable



Two products in 1



Cordless lamp  
200 Lumen



Equipped of  
magnetic system



**1.200 LUMEN**



**NEW**

**Rechargeable led under hood lamp  
with transparent and semi-transparent lens**

CODE	€/Pz
FG 209	260,00



Can extend 760mm



Charging control panel



1200 lumen



BRIGHT MODE

1100 lumen



COMFORTABLE MODE

600 lumen



SOFT MODE



**Rechargeable  
cob led lamp**

**600 LUMEN**

CODE	€/Pz
FG 211	110,00

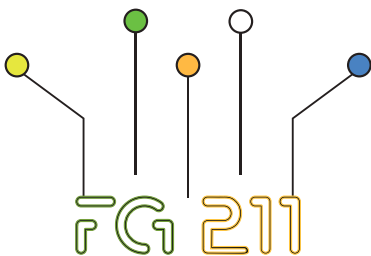

Top led  
- 120 Lumen



360°



Intensity  
regulator



Charge  
indicator

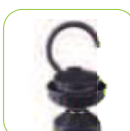

Magnetic base and  
removable hook



**Rechargeable  
cob led lamp**

**200 LUMEN**

CODE	€/Pz
FG 212	78,00



CE



Mini rechargeable cob led lamp

CODE	€/Pz
FG 210/A	90,00



- 700 lumen
- Li-ion battery
- magnetic
- Max 10h



700 LUMEN



Mini portable led lamp

CODE	€/Pz
FG 204	30,00

- 300 lumen
- Li-ion battery
- 2.5h
- Max 3h

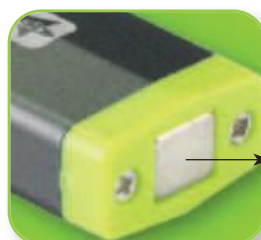

Equipped of magnetic system



CE

COMPACT, POCKET, POWERFUL  
TAKE IT WITH YOU ALWAYS!



NEW

Rechargeable led compact spotlight

equipped with rear magnets, intensity management function, double charging port. USB charging cable included. Body in anodized aluminum DIMMER MODE

CODE	€/Pz
FG 203	25,00

- MAX 100 lumen
- 0.5h
- Max 3h

CE



PORTABLE  
HANDY  
RECHARGEABLE



Micro USB and type C charging socket



Magnetic base



100 LUMEN

**Rechargeable led torch light**

CODE	€/Pz
FG 214/L600	85,00



LIGHT ADJUSTABLE  
CONE



SUPPORT PLATE WALL  
CONE

**RECHARGEABLE LED TORCH  
LIGHT LAST GENERATION  
600 LUMEN MAX DURATION 15H**



**Double led head lamp  
with on/off contactless sensor**

CODE	€/Pz
FG 213/L480	65,00



ON/OFF  
CONTACTLESS  
SENSOR



4 LEVELS OF  
INCLINATION



**680 LUMEN**

**WITH A SIMPLE ACTION  
YOU LIGHT UP YOUR WORK!**



EQUIPPED WITH 4 REAR MAGNETS  
FOR USE WITHOUT ELASTIC BAND



# GENERAL MAINTENANCE

## Portable led lamp

Equipped with upper led, removable hook, magnetic support base and rotating up to 180°. Including USB Type-C charging cable

CODE	€/Pz
FG 205	85,00



**NEW**



**420 LUMEN**

## HANDY AND MAGNETIC



Top led



Clip and hook



Charge indicator



Magnetic base

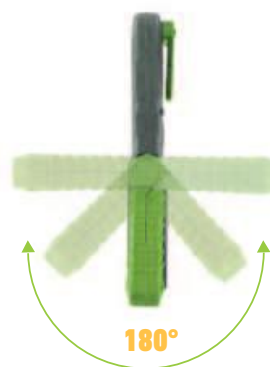

Basic rotation up to 180°

CE

## Long size magnetic recharge tube work light

equipped with top spot light, magnetic base, red emergency light mode. USB Type-C charging cable included

CODE	€/Pz
FG 210/B	85,00



**NEW**



**420 LUMEN**

CE



USB Type-C charging



Spot light 400 lumen

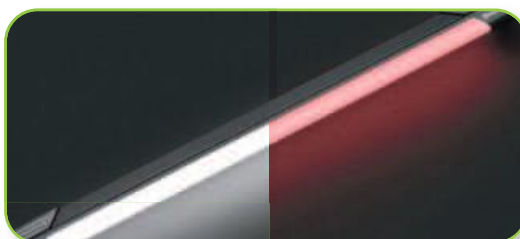

White floodlight 1200 LUMEN  
Red floodlight 50 LUMEN



Magnetic system



## VERSATILE AND MAGNETIC

**NEW**

**Rechargeable lamp with 3 led spotlights**  
Included telescopic adjustable tripod

CODE	€/Pz
FG 217	250,00



**VERSATILE  
POWERFUL  
ADJUSTABLE**



Clip and hook



Magnet



Control panel

CE



Cold white

Warm

**NEW**

**Cable reel 3Gx2.5mm<sup>2</sup>, 15mt - 230v**

Inlet cable length 1,20m

CODE	€/Pz
FG 225/SK2.5	370,00

15m x 3G2.5mm<sup>2</sup> ⚡ 1600W  
 ⚡ 230V AC ⚡ 3200W

**Cable reel 3Gx1.5mm<sup>2</sup>, 15mt - 230v**

Inlet cable length 1,20m

CODE	€/Pz
FG 225/SK1.5	300,00

15m x 3G 1.5mm<sup>2</sup> ⚡ 1000W  
 ⚡ 230V AC ⚡ 2000W

CE



**360° adjustable wall bracket**



RE-ENTRY LIMITER TO STOP THE RUN



STOP AT ANY POINT







# LAMPS WITH HIGH COLOR RENDERING

CAR BODY SECTOR



**Cob led head lamp cri 96 + 3 colors - on/off contactless sensor**

CODE	€/Pz
FG 234	105,00



**COB LED - cri 96+ 3 COLORS**

2700K 4500K 6500K

NEW

CE



on/off sensor contactless



4 inclination levels

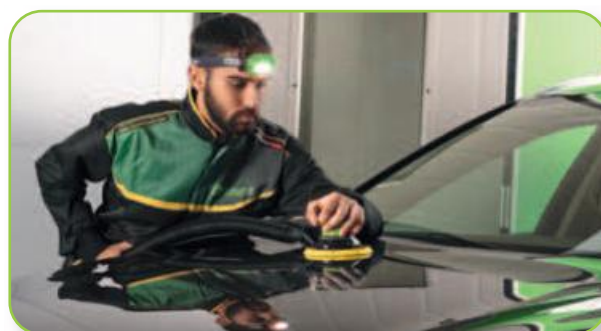

Clip and hook

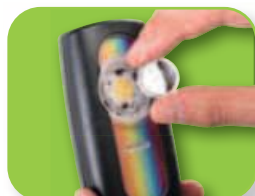

Replaceable lens

**Cob led lamp with high color rendering index led (cri 96+) - 3 colors**

CODE	€/Pz
FG 235	135,00



**COB LED - cri 96+ 3 COLORS**

2700K 4500K 6500K



CE

NEW

Charging base with usb socket + 1m usb cable



Magnetic base + back super magnet



**NEW**



CE

**Floodlight with high color rendering index led (cri 96+) 5 colors**  
**3 LUMINOUS 500 - 1000 - 2000 LUMEN**

CODE	€/Pz
FG 236	236,00



**LED - cri 96+**  
**5 COLORS**

**2700K 3500K 4500K 5500K 6500K**



Control panel



Quick release charger with 5m cable



**NEW**



**Worklight tripod for FG 236**

Net weight: 1098 g  
Height: 476 mm (folded) -1440 mm (extended)  
Sections: 3  
Maximum load: 2 kg

CODE	€/Pz
FG 236/SU	100,00





# 13

**PLUMBING TOOLS**



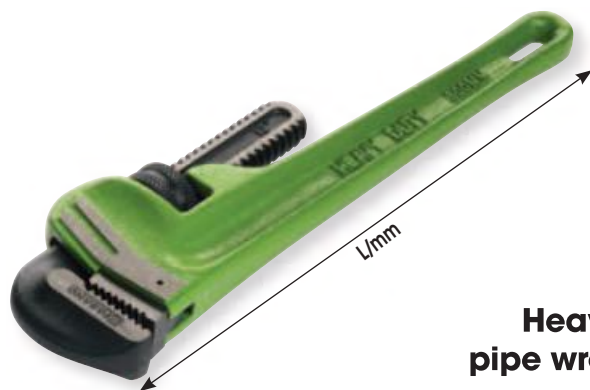

**Heavy-duty pipe wrenches**

CODE	Ø GAS max	Ø mm max	L/mm	€/Pz
FG 30/GA1	1"	34	200	27,00
FG 30/GA1.5	1"1/2	49	250	38,00
FG 30/GA2	2"	60	300	45,00
FG 30/GA2B	2"	60	350	52,00
FG 30/GA2.5	2"1/2	76	450	75,00
FG 30/GA3	3"	90	600	112,00

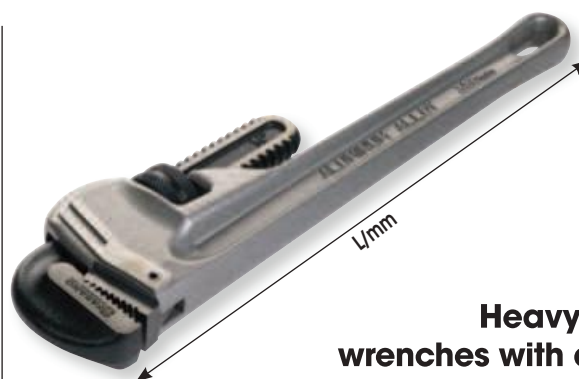

**Heavy-duty pipe wrenches with alloy body**

CODE	Ø GAS max	Ø mm max	L/mm	€/Pz
FG 33/GA2	2"	60	350	68,00
FG 33/GA2.5	2"1/2	76	450	96,00
FG 33/GA3	3"	90	600	145,00
FG 33/GA5	5"	140	900	290,00

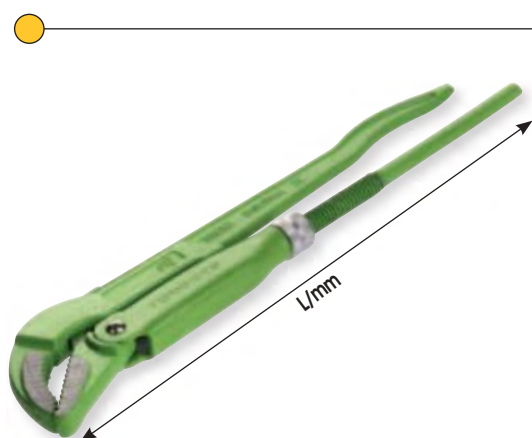

**Pipe wrenches, swedish pattern with 45° flat jaws**

CODE	Ø GAS max	Ø mm max	L/mm	€/Pz
FG 32/GP1	1"	34	320	32,00
FG 32/GP1.5	1"1/2	49	410	45,00
FG 32/GP2	2"	60	550	70,00

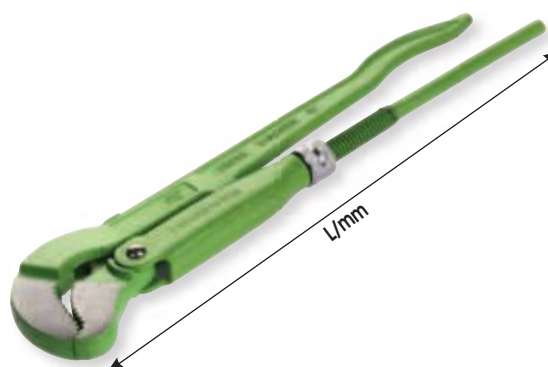

**Pipe wrenches, swedish pattern with 90° slim jaws**

CODE	Ø GAS max	Ø mm max	L/mm	€/Pz
FG 32/GS1	1"	34	320	32,00
FG 32/GS1.5	1"1/2	49	410	45,00
FG 32/GS2	2"	60	550	70,00



**Adjustable wrenches**

CODE	Ø GAS	Ø	L/mm	€/Pz
FG 34/GL1	1"	34	175	20,00
FG 34/GL1.5	1"1/2	49	225	25,00



**Tube flaring tool for copper and light alloy pipers**

Ø/mm: 4-16, 5/16"-5/8"

CODE	€/Pz
FG 20/A1	62,00



**Tube flaring tool for copper and light alloy pipers**

Ø/mm: 4, 4.75, 6, 8, 10, 12, 14

CODE	€/Pz
FG 20/A2	56,00

**Borchie per borda tubi**

CODE	mm	€/Pz
FG 20/AD4	4	5,00
FG 20/AD4.75	4.75	5,00
FG 20/AD6	6	5,00
FG 20/AD8	8	5,00
FG 20/AD10	10	5,00
FG 20/AD12	12	5,00
FG 20/AD14	14	5,00



**Set utensili per idraulica**

CODE	CONTENUTO	€/Pz
FG 21/S10	FG 20/A2	145,00
	FG 20/AD4 - FG 20/AD14	
	FG 76/R2	



**Pipe bending pliers**

CODE	CAPACITY	€/Pz
FG 24/CU1	6, 8, 10 mm	40,00
FG 24/CU2	1/4", 5/16", 3/8"	40,00



**Hinged water tap wrench**

Ø: 10-32mm, 8"-1.1/4"

CODE	€/Pz
FG 21/CD	31,00



**Sanitary wrench**

CODE	€/Pz
FG 21/CS	55,00

**Combination spud wrench with 5 steps**

CODE	€/Pz
FG 21/CR	38,00

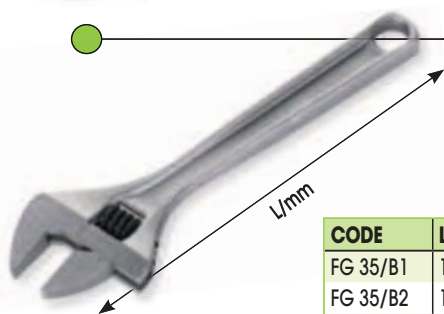

**Adjustable wrench**

CODE	L/mm	Ø/max	€/Pz
FG 35/B1	100 mm / 4"	15 mm	19,50
FG 35/B2	150 mm / 6"	24 mm	20,00
FG 35/B3	200 mm / 8"	28mm	25,00
FG 35/B4	250 mm / 10"	34 mm	31,00
FG 35/B5	300 mm / 12"	35 mm	40,00



**Adjustable wrench**

CODE	L/mm	Ø/max	€/Pz
FG 35/1	150 mm / 6"	24 mm	19,00

**Deburrer with revolving replacement blade**

CODE	€/Pz
FG 79/SR	16,50

**Curve blade:**

CODE	€/Pz
FG 79/SR1R	6,00



**Outside and inside metallic reamer**

CODE	CAPACITY	€/Pz
FG 79/SB	8 - 38 mm 1/8" - 1.5/8"	23,00





14

TOOL BAGS





# 14 TOOL BAGS

## Cantilever tool bag - 3 sections

CODE	DIMENSIONS	€/Pz
FG 111/A	430x160x200mm	60,00

- Designed to lock
- Metal body



## Cantilever tool bag - 5 sections

CODE	DIMENSIONS	€/Pz
FG 111/B	430x200x200mm	72,00
FG 111/C	530x200x200mm	85,00

- Designed to lock
- Metal body



## Tool trunk

CODE	DIMENSIONS	€/Pz
FG 112A	500X250X250mm	210,00
FG 112B	850X350X350mm	250,00

- Designed to lock
- Metal body



MADE IN ITALY



## Tool trunk with amovible internal pan

CODE	DIMENSIONS	€/Pz
FG 112/C	500X250X250mm	240,00
FG 112/D	850X350X350mm	290,00

- Designed to lock
- Metal body

MADE IN ITALY



## Cantilever tool bag w/5 sections and assortment 55 tools

CODE	Pz	€/Pz
FG 111/AS55	55	616,50



FG 111/C



FG 625/A	1/2"dr. HEX SOCKETS 8-32MM
FG 625/CR12	1/2"DR. REVERSIBLE RATCHET HANDLE
FG 625/PR125	1/2"DR. EXTENSION BAR - 125MM
FG 625/PR250	1/2"DR. EXTENSION BAR - 250MM
FG 625/SN12	1/2"DR. UNIVERSAL JOINT
FG 625/ES12	1/2"DR. SLIDING BAR
FG 22/...	SLOTTED SCREWDRIVERS 3X75, 4X100, 5.5X100, 6.5X100
FG 22/PH	PHILLIPS SCREWDRIVERS PH1X80, PH2X100
FG 69/CJ250	ADJUSTABLE LOCKING PLIERS 250mm
FG 35/B4	ADJUSTABLE WRENCH mm250
FG 59PV/180	COMBINATION PLIERS -180mm
FG 61PV/160	LONG NOSE PLIERS -160mm
FG 63PV/160	DIAGONAL CUTTING PLIERS -160mm
FG 139/B	SET OF 10PCS OFFSET HEXAGON KEY WRENCHES
FG 600/SP11	SET 11pcs COMBINATION WRENCHES 8-19mm

## Cantilever tool bag w/5 sections and assortment 104 tools

CODE	Pz	€/Pz
FG 111/AS104	104	835,80



FG 111/C



FG 625/A	1/2"dr. HEX SOCKETS 8-19MM
FG 625/CR12	1/2"DR. REVERSIBLE RATCHET HANDLE
FG 625/PR250	1/2"DR. EXTENSION BAR - 250MM
FG 625/SN12	1/2"DR. UNIVERSAL JOINT
FG 625/ES12	1/2"DR. SLIDING BAR
FG 624/S25	SET OF 1/4"DR. SOCKETS 4-14MM + ACCESSORIES
FG 22/...	SLOTTED SCREWDRIVERS 3X100, 4X125, 5.5X150, 6.5X150
FG 22/PH	PHILLIPS SCREWDRIVERS PH1X80, PH2X100
FG 58/B240	SLIP JOINT PLIERS 240MM
FG 69/CJ250	ADJUSTABLE LOCKING PLIERS 250mm
FG 85/S31	SET OF 30PCS 1/4"DR. BITS + BIT HOLDER
FG 43/MT3	TAPE METER 3MT.
FG 132/500	HAMMER WITH RESIN HANDLE - 500GR.
FG 59PV/180	COMBINATION PLIERS -180mm
FG 63PV/160	DIAGONAL CUTTING PLIERS -160mm
FG 139/B	SET OF 10PCS OFFSET HEXAGON KEY WRENCHES
FG 48/LG	PROFESSIONAL CUTTER
FG 49	ELECTRICIANS' SCISSOR
FG 600/SP9	SET 9pcs COMBINATION WRENCHES 8-19mm



## VERSATILITY IS IMPORTANT

With the modular and stackable Fasano Tools tool holder system, arrange the tool holders according to your needs. Suitable for every use, our Kit of 4 ABS cases allows you to work quickly, because you find everything you need exactly where it should be!



SHAPED HANDLE  
ON THE LID FOR  
EASY CARRING



DESIGNED  
TO LOCK



HEAVY DUTY  
CLOSING  
SYSTEM



LABEL HOLDER



## MODULAR ORGANIZER

The Fasano Tools case system has a modular design. Arrange the small parts, accessories and small tools inside the boxes as you wish!

SYSTEM OF  
LOCKING  
FRONT



## PORTABLE

## MODULAR

## SAFE AND DURABLE



**ABS tool case**

DIMENSION: 456x372x115mm

PESO: 2.1Kg

CODE	€/Pz
FG 1425	102,00



**ABS tool case**

DIMENSION: 456x372x155mm

PESO: 2.4Kg

CODE	€/Pz
FG 1426	120,00



LABEL HOLDER



DESIGNED TO LOCK

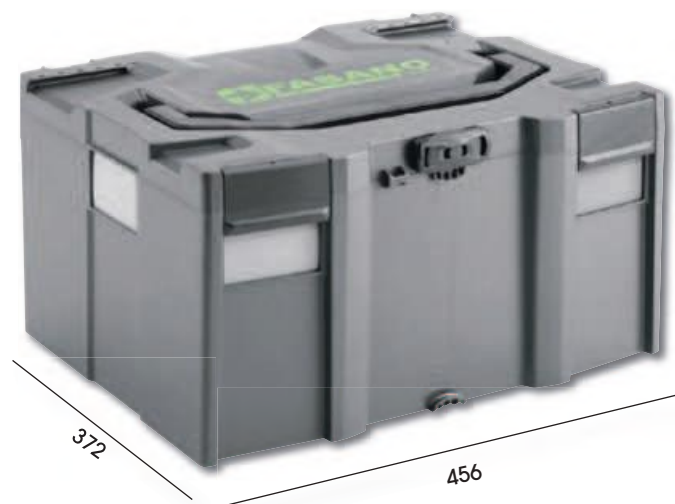

**ABS tool case**

DIMENSION: 456x372x262mm

PESO: 3Kg

CODE	€/Pz
FG 1427	170,00



STEEL SIDE CLIP



SHAPED HANDLE ON THE LID FOR EASY CARRING





CODE	€/Pz
FG 1434	145,00

### ABS tool case with internal boxes

DIMENSION: 456x372x115mm  
WEIGHT: 2.1Kg



CODE	€/Pz
FG 1432	130,00

### Support base with wheels

DIMENSION: 655x490x170mm  
WEIGHT: 2.4Kg  
LOAD: 100Kg



WHEELS Ø 90MM  
2 BRAKING



SYSTEM OF LOCKING

## ABS INTERNAL BOXES



CODE	€/Pz
FG 1434/V1	1,50

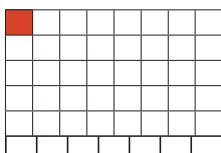

CODE	€/Pz
FG 1434/V2	2,00

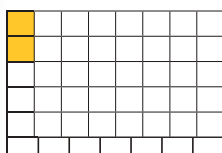

CODE	€/Pz
FG 1434/V3	4,00

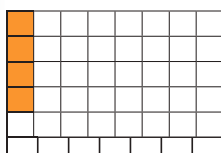

CODE	€/Pz
FG 1434/V4	3,50

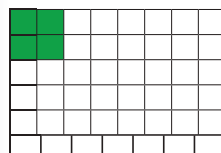

CODE	€/Pz
FG 1434/V5	4,00

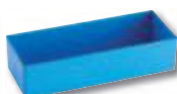
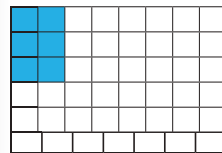

CODE	€/Pz
FG 1434/V6	6,50

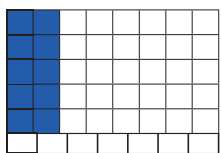

CODE	€/Pz
FG 1434/V7	9,00

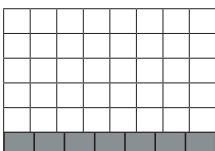

### Sponge thermoformed

CODE	€/Pz
FG 1434/EF	15,00

CODE	€/Pz
FG 1433	190,00

### Folding hand track

Iron structure - aluminum base  
WEIGHT: 6Kg - CAPACITY: 100Kg  
WHEELS Ø: 180mm

**NEW**

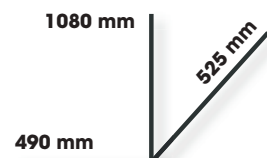

Chiuso: 70x485x835mm  
Base: 480x350mm



CODE	€/Pz
FG 109/L3	280,00

**Folding tool trolley**

WEIGHT: 11Kg  
CAPACITY: 300Kg

**NEW**



SYSTEM OF UNLOCKING



**Kit of 4 ABS cases with support base and internal boxes**

WEIGHT: 13.1Kg  
LOAD: 100Kg

CODE	€/Pz
FG 1438/S4B	680,00



FG 1434

FG 1425

FG 1426

FG 1427

FG 1432



CODE	€/Pz
FG 1438/S4C	730,00

**NEW**

**Kit of 4 stackable ABS suitcases complete with folding trolley**



**ABS tool case**

- 2 unstaking and separable compartments
- transparent front windows
- adjustable ergonomic handle

CODE	€/Pz
FG 114/L2	65,00

**Tool box with 3 shelves**

CODE	€/Pz
FG 114/L3	110,00

**NEW****Box equipped of 8 removable containers and adjustable dividers**

DIMENSION: 385x320x60mm

CODE	€/Pz
FG 1445	45,00

**Small parts holder box**

DIMENSION: 90x60x50mm

CODE	€/Pz
FG 1445/V1	3,00

**10 dividers**

CODE	€/Pz
FG 1445/D	5,50

**Box equipped of 12 removable containers and adjustable dividers**

DIMENSION: 400x400x70mm

CODE	€/Pz
FG 1440	60,00

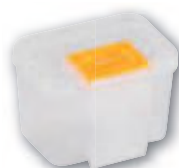
**Small parts holder box**

DIMENSION: 95x75x65mm

CODE	€/Pz
FG 1440/V1	3,00

**Small parts holder box**

DIMENSION: 145x75x65mm

CODE	€/Pz
FG 1440/V2	4,00



### Nylon tool bag

- Comfortable chair system
- Steel support structure
- Anti-scrape system
- Adjustable belts
- Waterproof nylon fabric

CODE	€/Pz
FG/XTV	120,00



### Nylon tool bag

- Comfortable chair system
- Steel support structure
- Anti-scrape system
- Adjustable belts
- Waterproof nylon fabric

CODE	€/Pz
FG/XTV2	120,00



### Leather tool bags for electricians

- 2 pouches for tools & pieces
- bag belt

CODE	€/Pz
FG/XTP1	140,00



### Nylon tool bag

- removable inside forms
- 2 special pouch for documents
- Adjustable belt
- Waterproof nylon fabric

CODE	€/Pz
FG/EBV	40,00





### Polypropylene tool case - BASIC model

- central lock with key
- 2 side closing
- document area
- metal lid support stay

CODE	€/Pz
FG 115/A	250,00

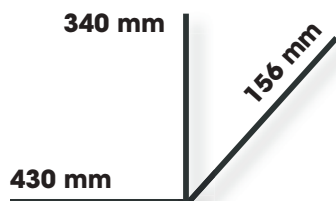

### High thickness ABS tool case

- 2 side locks with keys
- soft grip handle
- bottom tray with removable dividers

CODE	€/Pz
FG 115/B	290,00

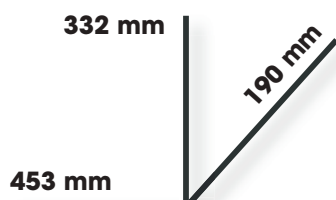



**Polypropylene tool case  
- HEAVY DUTY**

- 2 metal lid safety support stays
- 2 metal locks with keys
- 3 metal hinges for maximum strength
- bottom area with adjustable dividers
- address label

CODE	€/Pz
FG 116/A	390,00

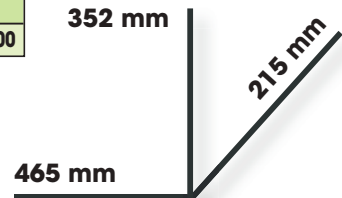

**Polypropylene tool TROLLEY  
- HEAVY DUTY**

- 2 side locks with keys
- soft grip handle
- bottom tray with removable dividers

CODE	€/Pz
FG 117/A	420,00

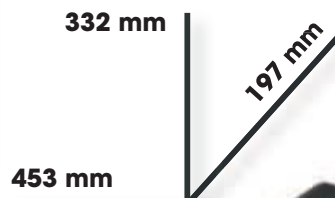



### Assortment of 76 tools

CODE	€/Pz
FG 118/AS76	848,90

FG 22E/2.5X75	2.5x75 mm INSULATED SLOTTED SCREWDRIVER	FG 22/FX8	8 mm HEXAGON NUT SPINNER WITH HANDLE
FG 22E/3X100	3x100 mm INSULATED SLOTTED SCREWDRIVER	FG 22/FX10	10 mm HEXAGON NUT SPINNER WITH HANDLE
FG 22E/4X100	4x100 mm INSULATED SLOTTED SCREWDRIVER	FG 22/FX13	13 mm HEXAGON NUT SPINNER WITH HANDLE
FG 22E/5.5X125	5.5x125 mm INSULATED SLOTTED SCREWDRIVER	FG 58/IS250	INSULATED ADJUSTABLE PLIERS
FG 22E/6.5X150	6.5x150 mm INSULATED SLOTTED SCREWDRIVER	FG 59/IS180	INSULATED COMBINATION PLIER
FG 22E/PH0X60	PH0x60 INSULATED PHILLIPS SCREWDRIVER	FG 61/IS200	INSULATED LONG NOSE PLIERS
FG 22E/PH1X80	PH1x80 INSULATED PHILLIPS SCREWDRIVER	FG 63/IS160	INSULATED DIAGONAL CUTTING PLIERS
FG 22E/PH2X100	PH2x100 INSULATED PHILLIPS SCREWDRIVER	FG 68IS/160	INSULATED WIRE STRIPPING PLIERS
FG 128/BU2	HAND CENTRE PUNCH	FG 49	ELECTRICIAN'S SCISSORS
FG 126/SL1	LONG CHISEL FOR ELECTRICIANS	FG 48/IS	INSULATED CUTTER
FG 126/SL2	LONG CHISEL FOR ELECTRICIANS	FG 68/S1	CRIMPING PLIERS FOR INSULATED TERMINALS
FG 127/P1	ULTRA-FLAT CHISEL mm26x240L	FG 22/CF250	CIRCUIT TESTER 110/250V
FG 93/M24	TELESCOPE INSPECTION MIRROR	FG 68/CS2	CABLE STRIPPER
FG 602/SP9	SET OF 9 PCS OF OPEN END WRENCHES IN NYLON POUCH	FG 48/L	PROFESSIONAL CUTTER WITH LONG BLADE
FG 139/C	SET OF 10 OFFSET HEXAGON KEY WRENCHES - LONG SERIES	FG 136/L35	DEAD-BLOW HAMMERS
FG 138/C	SET OF 10 OFFSET TORX KEY WRENCHES - LONG SERIES	FG 132/300	ENGINEER'S HAMMER WITH ANTI-VIBRATION HANDLE
FG 96/SS36	SOLDERING IRON - DUAL POWER	FG 81/PT2	BLACK STEEL, HARDENED TIPS (STRAIGHT-BENT)
FG 22/FX5	5 mm HEXAGON NUT SPINNER WITH HANDLE	FG 44/MT5	MEASURING TAPE 5MX25MM
FG 22/FX6	6 mm HEXAGON NUT SPINNER WITH HANDLE	FG 50/MS	MINI HACKSAW WITH CARBON STEEL BLADE
FG 22/FX7	7 mm HEXAGON NUT SPINNER WITH HANDLE	FG 83/S6	SET OF NEEDLE FILES WITH HANDLES IN NYLON POUCH
		FG 497/OP2	OIL CAN WITH BRASS RETRACTABLE SPOPOT
		FG 48200N	SET OF 200 PCS OF NYLON CABLE TIES 4.8x200mm
		FG 36150N	SET OF 200 PCS OF NYLON CABLE TIES 3.6x150mm



## Assortment of 40 tools

CODE	€/Pz
FG 118/AS40	1.055,00

FG 22E/2.5x75	2.5x75 mm INSULATED SLOTTED SCREWDRIVER	FG 22/FX7	7 mm HEXAGON NUT SPINNER WITH HANDLE
FG 22E/3x100	3x100 mm INSULATED SLOTTED SCREWDRIVER	FG 22/FX8	8 mm HEXAGON NUT SPINNER WITH HANDLE
FG 22E/4x100	4x100 mm INSULATED SLOTTED SCREWDRIVER	FG 22/FX10	10 mm HEXAGON NUT SPINNER WITH HANDLE
FG 22E/5.5x125	5.5x125 mm INSULATED SLOTTED SCREWDRIVER	FG 22/FX13	13 mm HEXAGON NUT SPINNER WITH HANDLE
FG 22E/6.5x150	6.5x150 mm INSULATED SLOTTED SCREWDRIVER	FG 58/IS250	INSULATED ADJUSTABLE PLIERS
FG 22E/8x175	8x175mm INSULATED SLOTTED SCREWDRIVER	FG 59/IS180	INSULATED COMBINATION PLIER
FG 22E/PH0x60	PH0x60 INSULATED PHILLIPS SCREWDRIVER	FG 61/IS200	INSULATED LONG NOSE PLIERS
FG 22E/PH1x80	PH1x80 INSULATED PHILLIPS SCREWDRIVER	FG 63/IS160	INSULATED DIAGONAL CUTTING PLIERS
FG 22E/PH2x100	PH2x100 INSULATED PHILLIPS SCREWDRIVER	FG 68IS/160	INSULATED WIRE STRIPPING PLIERS
FG 22E/PH3x150	PH3x150 INSULATED PHILLIPS SCREWDRIVER	FG 49/E	ELECTRICIAN'S INSULATED SCISSOR
FG 22E/PZ0x60	PZ0x60 INSULATED POZIDRIVE SCREWDRIVER	FG 48/IS	INSULATED CUTTER
FG 22E/PZ1x80	PZ1x80 INSULATED POZIDRIVE SCREWDRIVER	FG 603/SP6	SET OF INSULATED WRENCHES
FG 22E/PZ2x100	PZ2x100 INSULATED POZIDRIVE SCREWDRIVER	FG 22/CF250	CIRCUIT TESTER 110/250V
FG 22E/PZ3x150	PZ3x150 INSULATED POZIDRIVE SCREWDRIVER	FG 35/E250	INSULATED ADJUSTABLE WRENCH
FG 96/SS36	SOLDERING IRON - DUAL POWER	FG 136/L35	DEAD-BLOW HAMMERS
FG 98/SS	DESOLDERING PUMP	FG 93/P	TELESCOPE INSPECTION MIRROR
FG 22/FX5	5 mm HEXAGON NUT SPINNER WITH HANDLE	FG 96/DG	DC/AC-OHM DIGITAL MULTIMETER
FG 22/FX6	6 mm HEXAGON NUT SPINNER WITH HANDLE		





### Assortment of 56 tools

CODE	€/Pz
FG 118/AS56	749,90

FG 22E/2.5x75	2.5x75 mm INSULATED SLOTTED SCREWDRIVER	FG 22/FX10	10 mm HEXAGON NUT SPINNER WITH HANDLE
FG 22E/3x100	3x100 mm INSULATED SLOTTED SCREWDRIVER	FG 22/FX13	13 mm HEXAGON NUT SPINNER WITH HANDLE
FG 22E/4x100	4x100 mm INSULATED SLOTTED SCREWDRIVER	FG 58/IS250	INSULATED ADJUSTABLE PLIERS
FG 22E/5.5x125	5.5x125 mm INSULATED SLOTTED SCREWDRIVER	FG 59/IS180	INSULATED COMBINATION PLIER
FG 22E/6.5x150	6.5x150 mm INSULATED SLOTTED SCREWDRIVER	FG 61/IS200	INSULATED LONG NOSE PLIERS
FG 22E/PH0x60	PH0x60 INSULATED PHILLIPS SCREWDRIVER	FG 63/IS160	INSULATED DIAGONAL CUTTING PLIERS
FG 22E/PH1x80	PH1x80 INSULATED PHILLIPS SCREWDRIVER	FG 68IS/160	INSULATED WIRE STRIPPING PLIERS
FG 22E/PH2x100	PH2x100 INSULATED PHILLIPS SCREWDRIVER	FG 49	ELECTRICIAN'S SCISSORS
FG 129/C4	4 MM PIN PUNCH	FG 48/IS	INSULATED CUTTER
FG 129/C5	5 MM PIN PUNCH	FG 68/S1	CRIMPING PLIERS FOR INSULATED TERMINALS
FG 126/SL1	LONG CHISEL FOR ELECTRICIANS	FG 22/CF250	CIRCUIT TESTER 110/250V
FG 126/SL2	LONG CHISEL FOR ELECTRICIANS	FG 68/CS2	CABLE STRIPPER
FG 127/P1	ULTRA-FLAT CHISEL mm26x240L	FG 48/L	PROFESSIONAL CUTTER WITH LONG BLADE
FG 602/SP9	SET OF 9 PCS OF OPEN END WRENCHES IN NYLON POUCH	FG 136/L35	DEAD-BLOW HAMMERS
FG 139/C	SET OF 10 OFFSET HEXAGON KEY WRENCHES - LONG SERIES	FG 132/300	ENGINEER'S HAMMER WITH ANTI-VIBRATION HANDLE
FG 96/SS36	SOLDERING IRON - DUAL POWER	FG 81/PT2	BLACK STEEL, HARDENED TIPS (STRAIGHT-BENT)
FG 22/FX5	5 mm HEXAGON NUT SPINNER WITH HANDLE	FG 44/MT5	MEASURING TAPE 5MX25MM
FG 22/FX6	6 mm HEXAGON NUT SPINNER WITH HANDLE	FG 50/MS	MINI HACKSAW WITH CARBON STEEL BLADE
FG 22/FX7	7 mm HEXAGON NUT SPINNER WITH HANDLE	FG 497/OP2	OIL CAN WITH BRASS RETRACTABLE SOPUT
FG 22/FX8	8 mm HEXAGON NUT SPINNER WITH HANDLE		



## Assortment of 44 tools

CODE	€/Pz
FG 118/AS44	573,40

FG 602/SP9	SET OF 9 PCS OF OPEN END WRENCHES IN NYLON POUCH
FG 126/SN3	RIBBED CHISEL
FG 58/B240	240mm ADJUSTABLE PLIER
FG 32/GP1	45°-1" PIPE WRENCH, SWEDISH PATTERN 45° FLAT JAWS
FG 34/GL1.5	1"1/2 ADJUSTABLE PIPE WRENCH
FG 76/R3	TUBE CUTTER
FG 69/CJ250	250mm ADJUSTABLE SELF-LOCKING PLIERS, CURVE JAWS
FG 35/B4	ADJUSTABLE WRENCH
FG 22/3x75	3x75 mm SLOTTED SCREWDRIVER
FG 22/4x100	4X100mm SLOTTED SCREWDRIVER
FG 22/5.5x150	5.5X150 mm SLOTTED SCREWDRIVER
FG 22/8x200	8X200 mm SLOTTED SCREWDRIVER
FG 22/PH1x80	PH1x80 PHILLIPS SCREWDRIVER
FG 22/PH2x100	PH2X100 PHILLIPS SCREWDRIVER

FG 132/300	ENGINEER'S HAMMER WITH ANTI-VIBRATION HANDLE
FG 46/FR2	FOLDING RULER MADE IN FIBERGLASS
FG 59SR/180	180mm UNIVERSAL PLIERS
FG 49	ELECTRICIAN'S SCISSOR
FG 49/HE300	TIN SNIPS STRAIGHT WIDE BLADES - HEAVY DUTY MODEL
FG 94/300	SPIRIT MAGNETIC LEVEL WITH 3 INFRANGIBLE VIALS
FG 44/MT5	MEASURING TAPE 5mx25mm
FG 80/8AP	200mm FLAT SECOND CUT FILE WITH HANDLE - 8"
FG 80/8AQ	200mm SQUARE SECOND CUT FILE WITH HANDLE - 8"
FG 81/MS	PROFESSIONAL PENCIL
FG 79/SP3	WIRE BRUSH WITH STEEL WIRES
FG 79/SR	DEBURRER WITH REVOLVING REPLACEMENT BLADE
FG 139/C	SET OF 10 OFFSET HEXAGON KEY WRENCHES - LONG SERIES





### Assortment of 75 tools

CODE	€/Pz
FG 118/AS75	564,40

FG 602/SP9	SET OF 9 PCS OF OPEN END WRENCHES IN NYLON POUCH	FG 35/B4	ADJUSTABLE WRENCH
FG 22/2.5x75	2.5x75 mm SLOTTED SCREWDRIVER	FG 132/500	ENGINEER'S HAMMER WITH ANTI-VIBRATION HANDLE - 500 g
FG 22/3.5x100	3.5X100mm SLOTTED SCREWDRIVER	FG 49	ELECTRICIAN'S SCISSOR
FG 22/4x150	4X150 mm SLOTTED SCREWDRIVER	FG 44/MT5	MEASURING TAPE 5mx25mm
FG 22/6.5x150	6.5X150 mm SLOTTED SCREWDRIVER	FG 80/8AP	200mm FLAT SECOND CUT FILE WITH HANDLE - 8"
FG 22/8x150	8X150mm SLOTTED SCREWDRIVER	FG 80/8AQ	200mm SQUARE SECOND CUT FILE WITH HANDLE - 8"
FG 22/PH0x60	PH0X60 PHILLIPS SCREWDRIVER	FG 81/MS	PROFESSIONAL PENCIL
FG 22/PH1x80	PH1X80 PHILLIPS SCREWDRIVER	FG 48/L	PROFESSIONAL CUTTER WITH LONG BLADE
FG 22/PH2x150	PH2X150 PHILLIPS SCREWDRIVER	FG 79/SP3	WIRE BRUSH WITH STEEL WIRES
FG 58/B240	240mm ADJUSTABLE PLIER	FG 139/C	SET OF 10 OFFSET HEXAGON KEY WRENCHES - LONG SERIES
FG 59SR/180	180mm UNIVERSAL PLIERS	FG 85/S31	SET OF 31 PCS 1/4" DR. BITS
FG 61SR/160	160mm SOFT-RUN LONG NOSE PLIERS	FG 94/300	SPIRIT MAGNETIC LEVEL WITH 3 INFRANGIBLE VIALS
FG 63SR/160	160mm SOFT-RUN DIAGONAL CUTTING PLIERS	FG 88/P14	1/4" BIT HOLDER SCREWDRIVER
FG 49/HE250	TIN SNIPS STRAIGHT WIDE BLADES - HEAVY DUTY MODEL		
FG 69/CJ250	250mm ADJUSTABLE SELF-LOCKING PLIERS, CURVE JAWS		







FASANO

 **FASANO**  
TOOLS

15

**TOOL TROLLEYS  
& WORKBENCHES**



# FG 100



NEW  
LATERAL  
LOCK SYSTEM



UPPER  
ABS SHELF



DRAWER WITH  
OPENING  
COMPLETE



MADE IN ITALY

RAL  
7021

FG 100D/6T



RAL  
9016

FG 100W/6T



RAL  
6018

FG 100V/6T



RAL  
5002

FG 100B/6T



RAL  
3001

FG 100R/6T



AVAILABLE IN 5 DIFFERENT  
KINDS OF COLOR

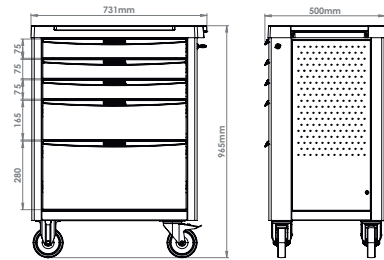

## FG 100V/5T Tool trolley with 5 drawers

### TECHNICAL FEATURES:

- Ball bearing slidings with telescopic system
- 4pcs wheel in no-marking rubber, Ø125mm (2 fixed and 2 swivel)
- central closing system
- drawers equipped with internal rubber mat
- ABS upper shelf & lateral tools racks



NEW

NEW



LOAD CAPACITY **KG 800**

CODE	Drawers	€/Pz
FG 100V/5T, FG 100B/5T, FG 100R/5T, FG 100D/5T, FG 100W/5T	5	1.000,00

FG 100B/5T

FG 100R/5T

FG 100D/5T

FG 100W/5T



## FG 100V/6T Tool trolley with 6 drawers

### TECHNICAL FEATURES:

- Ball bearing slidings with telescopic system
- 4pcs wheel in no-marking rubber, Ø125mm (2 fixed and 2 swivel)
- central closing system
- drawers equipped with internal rubber mat
- ABS upper shelf & lateral tools racks

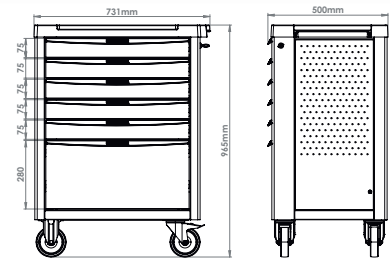

NEW

NEW



LOAD CAPACITY **KG 800**

CODE	Drawers	€/Pz
FG 100V/6T, FG 100B/6T, FG 100R/6T, FG 100D/6T, FG 100W/6T	6	1.050,00

FG 100D/6T

FG 100W/6T

FG 100B/6T

FG 100R/6T

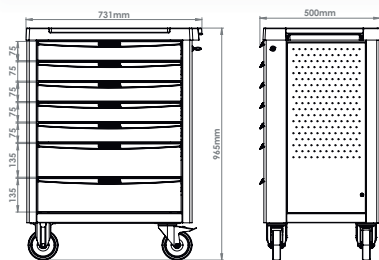

## FG 100V/7T Tool trolley with 7 drawers

### TECHNICAL FEATURES:

- Ball bearing slidings with telescopic system
- 4pcs wheel in no-marking rubber, Ø125mm (2 fixed and 2 swivel)
- central closing system
- drawers equipped with internal rubber mat
- ABS upper shelf & lateral tools racks



NEW

NEW



LOAD CAPACITY **KG 800**

CODE	Drawers	€/Pz
FG 100V/7T, FG 100B/7T, FG 100R/7T, FG 100D/7T, FG 100W/7T	7	1.100,00

FG 100B/7T

FG 100R/7T

FG 100D/7T

FG 100W/7T



## FG 102/FG 104 series

MADE IN ITALY



### TECHNICAL FEATURES:

- Ball bearing slidings with telescopic system
- 4pcs wheel in no-marking rubber, Ø125mm (2 fixed and 2 swivel)
- stainless steel side handle
- central closing system
- drawers equipped with internal rubber mat
- Drawer capacity FG 102: 45Kg
- Drawer capacity FG 104: 60Kg

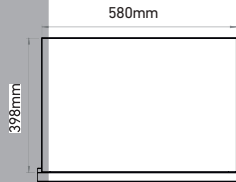

DRAWER DIMENSIONS FG 102

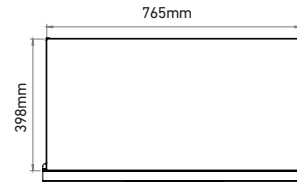

DRAWER DIMENSIONS FG 104



FG 102/AR: Anti-tilt system (under requirement): 120,00€

FG 104/AR: Anti-tilt system (under requirement): 120,00€



RUBBER TOP VERSION



STAINLESS STEEL HANDLE



CENTRAL CLOSING



INTERNAL MAT

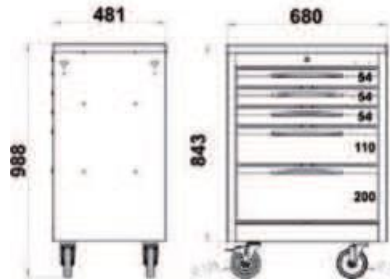

### Tool boxes with 5 drawers - mod. FG 102

**KG 800** LOAD CAPACITY

CODE	Drawers number	€/Pz
FG 102V/5G, FG 102R/5G, FG 102D/5G, FG 102B/5G	5	960,00



FG 102D/5G

FG 102B/5G

FG 102R/5G

FG 102V/5G

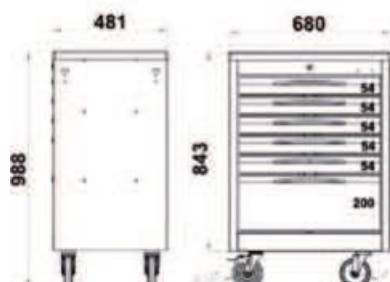

### Tool boxes with 6 drawers - mod. FG 102

**KG 800** LOAD CAPACITY

CODE	Drawers number	€/Pz
FG 102V/6G, FG 102R/6G, FG 102D/6G, FG 102B/6G	6	1.030,00



FG 102D/6G

FG 102B/6G

FG 102R/6G

FG 102V/6G

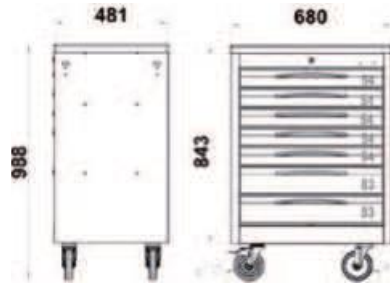

**Tool boxes with 7 drawers - mod. FG 102**

**KG 800** LOAD CAPACITY

CODE	Drawers number	€/Pz
FG 102V/7G, FG 102R/7G, FG 102D/7G, FG 102B/7G	7	1.100,00



FG 102D/7G    FG 102B/7G    FG 102R/7G    FG 102V/7G



**Tool boxes with 8 drawers - mod. FG 102**

**KG 800** LOAD CAPACITY

CODE	Drawers number	€/Pz
FG 102V/8G, FG 102R/8G, FG 102D/8G, FG 102B/8G	8	1.150,00



FG 102D/8G    FG 102B/8G    FG 102R/8G    FG 102V/8G

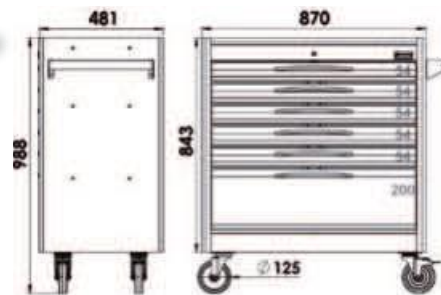

**Tool boxes with 6 drawers - mod. FG 104**

**KG 1000** LOAD CAPACITY

CODE	Drawers number	€/Pz
FG 104D/6G, FG 104B/6G, FG 104R/6G, FG 104V/6G	6	1.250,00



FG 104D/6G    FG 104B/7G    FG 104R/7G    FG 104V/7G

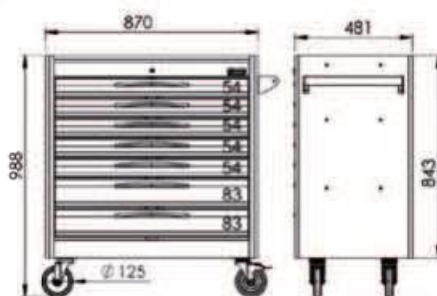

**Tool boxes with 7 drawers - mod. FG 104**

**KG 1000** LOAD CAPACITY

CODE	Drawers number	€/Pz
FG 104D/7G, FG 104B/7G, FG 104R/7G, FG 104V/7G	7	1.350,00



FG 104D/6G    FG 104B/7G    FG 104R/7G    FG 104V/7G



# Gamma FG 101

# FG101



### TECHNICAL FEATURES:

- Ball bearing slidings with telescopic system
- 4pcs wheel in no-marking rubber, Ø125mm (2 fixed and 2 swivel)
- steel side handle
- central closing system
- drawers equipped with internal rubber mat
- Drawer's loading capacity: 35Kg

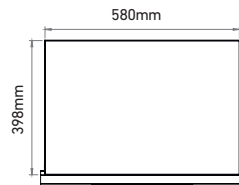

DRAWER DIMENSIONS FG 101



RUBBER TOP



STEEL SIDE HANDLE



NEW HANDLE CLOSING SYSTEM



WHEELS Ø125mm

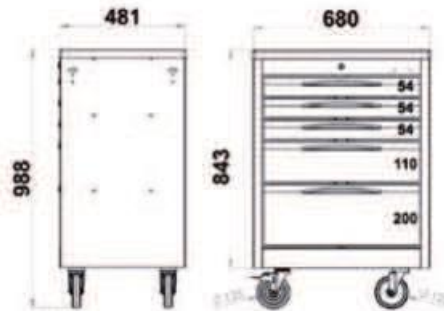

### Tool boxes with 5 drawers - mod. FG 101



CODE	Drawers' number	€/Pz
FG 101V/5G	5	680,00

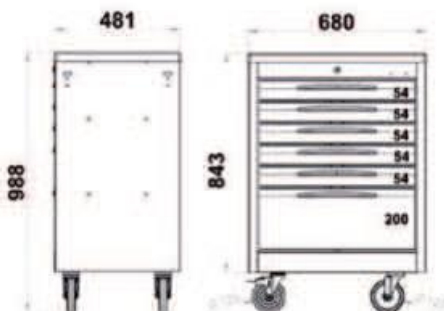

### Tool boxes with 6 drawers - mod. FG 101



CODE	Drawers' number	€/Pz
FG 101V/6G	6	710,00

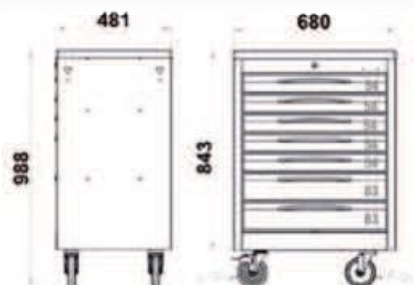

### Tool boxes with 7 drawers - mod. FG 101



CODE	Drawers' number	€/Pz
FG 101V/7G	7	750,00



### Tool boxes with 3 drawers - mod. FG 101

#### TECHNICAL FEATURES:

- top/Bottom shelf for pieces and objects
- Steel painted body
- Drawer's loading capacity: 20Kg
- Shelves' loading capacity: 35Kg
- Total weight: 26.5Kg

CODE	Drawers	€/Pz
FG 101V/3G	3	500,00

**NEW**



02 TOP & BOTTOM SHELVES FOR PIECES AND OBJECTS 680X440MM



STEEL SIDE HANDLE



POSSIBILITY TO INSERT TOOLS' FORMS



SISTEMA DI APERTURA A BAIONETTA



### Multi-service trolley for pieces and objects

#### TECHNICAL FEATURES:

- Aluminium body. Total weight: 3,94Kg
- 03 ABS shelves with removable dividers
- Loading capacity of top shelf: 10Kg
- Loading capacity of bottom shelf: 20Kg
- 04 wheels Ø 76mm (2 swivel with brake and 1 swivel without brake)

CODE	€/Pz
FG 108/B	250,00

**NEW**



EQUIPPED OF 16 REMOVABLE PLASTIC TRAYS FOR PIECES



REMOVABLE DIVIDERS ON EACH SHELVES



ALUMINUM BODY AND ABS SHELVES & ACCESSORIES



### Portable tool chest with 6 drawers

#### TECHNICAL FEATURES:

- Top shelf with GAS pistons 650x300x65mm
- 03 drawers 268x165x35mm
- 03 drawers 560x270x35mm
- centralized front lock
- side handles for transport

CODE	€/Pz
FG 110	380,00





MADE IN ITALY

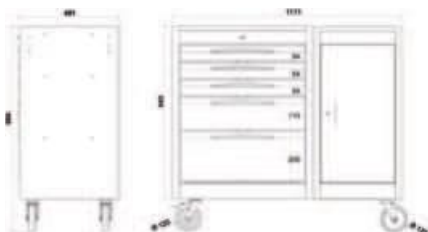

Tool box equipped with side cabinet

CODE	Number drawers	€/Pz
FG 105D/5G, FG 105B/5G, FG 105R/5G, FG 105V/5G	5	1.300,00

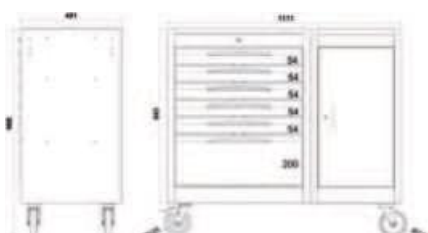

Tool box equipped with side cabinet

CODE	Number drawers	€/Pz
FG 105D/6G, FG 105B/6G, FG 105R/6G, FG 105V/6G	6	1.400,00

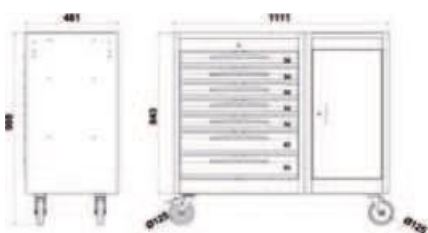

Tool box equipped with side cabinet

CODE	Number drawers	€/Pz
FG 105D/7G, FG 105B/7G, FG 105R/7G, FG 105V/7G	7	1.450,00





**Tool box equipped with side cabinet**

CODE	Number drawers	€/Pz
FG 109D/6G, FG 109B/6G, FG 109R/6G	6	1.600,00

**Tool box equipped with side cabinet**

CODE	Number drawers	€/Pz
FG 109D/7G, FG 109B/7G, FG 109R/7G	7	1.650,00



90° opening door, equipped with key lock



Rubber top



Internal shelves removable and adjustable

## FG 150 series

MADE IN ITALY



### TECHNICAL FEATURES:

- Ball bearing slidings with telescopic system
- 4pcs wheel in no-marking rubber, Ø125mm (2 fixed and 2 swivel)
- stainless steel side handle
- central closing system
- drawers equipped with internal rubber mat
- Drawer capacity FG 150: 30Kg

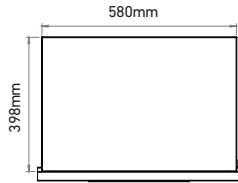

DRAWER DIMENSIONS FG 150



RUBBER TOP



STAINLESS STEEL HANDLE

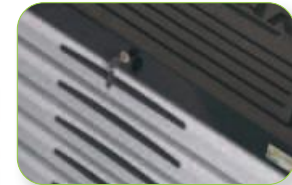

CENTRAL CLOSING

### Tool boxes with 5 drawers - mod. FG 150

CODE	Drawers	€/Pz
FG 150D/5G, FG 150R/5G	5	1.000,00



**KG 800** LOAD CAPACITY

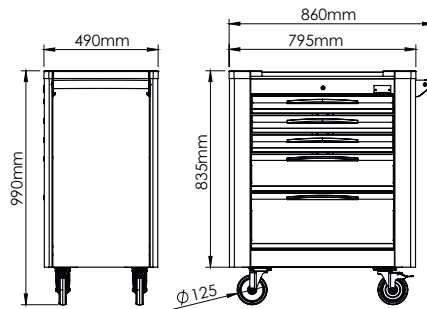

### Tool boxes with 6 drawers - mod. FG 150

CODE	Drawers	€/Pz
FG 150D/6G, FG 150R/6G	6	1.050,00



**KG 800** LOAD CAPACITY

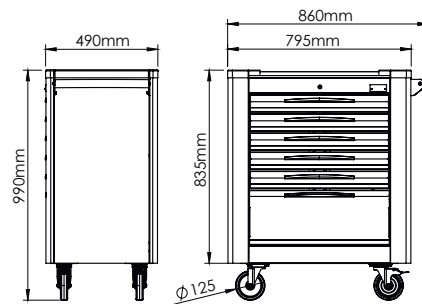

### Tool boxes with 7 drawers - mod. FG 150

CODE	Drawers	€/Pz
FG 150D/7G, FG 150R/7G	7	1.050,00



**KG 800** LOAD CAPACITY

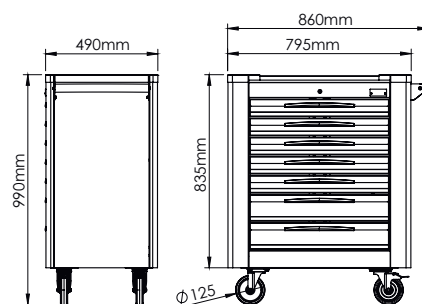



**Tool boxes with 14 drawers - mod. FG 160**

CODE	Number drawers	€/Pz
FG 160V/14L, FG 160B/14L, FG 160R/14L, FG 160D/14L	14	3.550,00



FG 160V/14L



FG 160B/14L



FG 160R/14L



FG 160D/14L

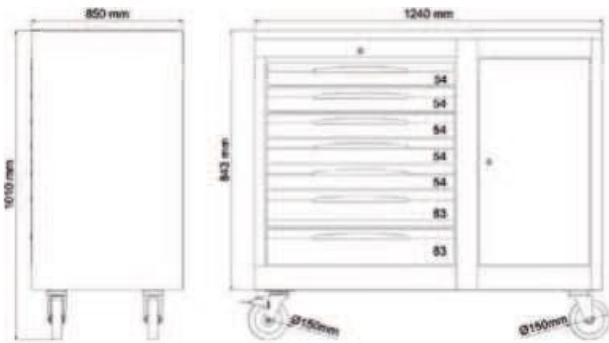

**TECHNICAL FEATURES:**

- Ball bearing telescopic slidings
- 4 wheel in no-marking rubber, Ø160mm (2 fixed and 2 swivel)
- stainless steel side handle
- central closing system
- drawers equipped with internal rubber mat

**KG**  
**2.400** **LOAD**  
**CAPACITY**



- 90° opening, equipped with key lock
- Internal shelves removable and adjustable



- Possibility to apply several lateral accessories



- Large side panel for tools  
Dimension: 665X595mm



- 7 small drawers for pieces  
Dimension: 580x235mm



## 14pcs combination wrenches form



CODE	€/Pz
FG 100/03G	150,00
FG TER 100/03G	24,00

FG 600/B6, 7, 8, 9, 10, 11, 12, 13, 14, 15, 16, 17, 18, 19mm

1/3		
-----	--	--

## 18pcs combination wrenches form



CODE	€/Pz
FG 100/03H	290,00
FG TER 100/03H	48,00

FG 600/B6, 7, 8, 10, 11, 12, 13, 14, 16, 17, 18, 19, 21, 22, 24, 27, 30, 32mm

2/3		
-----	--	--

## 5 double open end wrenches form

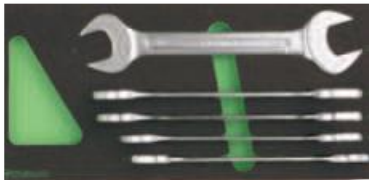

CODE	€/Pz
FG 100/03F	100,00
FG TER 100/03F	24,00

FG 602/B21x23, 24x26, 25x28, 27x29, 30x32 mm

1/3		
-----	--	--

## 4 double ended Torx wrenches form



CODE	€/Pz
FG 100/03TX	60,00
FG TER 100/03TX	15,00

FG 600/E6xE8, E10xE12, E14xE18, E20xE24

1/6		
-----	--	--

## 8 gear combination wrenches form



CODE	€/Pz
FG 100/08C	240,00
FG TER 100/08C	24,00

FG 605/B8, 10, 11, 12, 13, 14, 15, 16, 17, 18, 19mm

1/3		
-----	--	--

## 8 THandle wrenches form

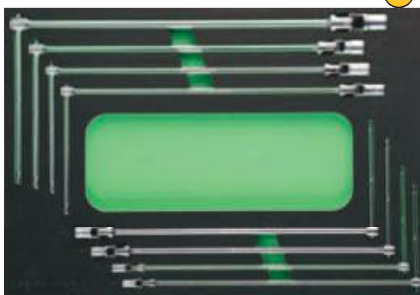

CODE	€/Pz
FG 100/10C	361,00
FG TER 100/10C	70,00

FG 618/A7, 8, 10, 11, 13, 14, 17, 19 mm

1/1		
-----	--	--

## 6pcs combination wrenches form



CODE	€/Pz
FG 100/03L	145,00
FG TER 100/03L	24,00

FG 600/B21, 22, 24, 27, 30, 32mm

1/3		
-----	--	--

## 8pcs double open end wrenches form

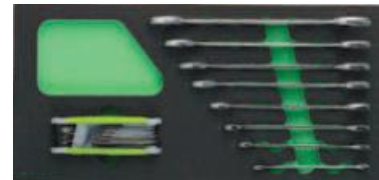

CODE	€/Pz
FG 100/03E	90,00
FG TER 100/03E	24,00

FG 602/B6x7, 8x9, 10x11, 12x13, 14x15, 16x17, 18x19, 20x22 mm + FG 139C/FS

1/3		
-----	--	--

## 7 double ended offset wrenches form

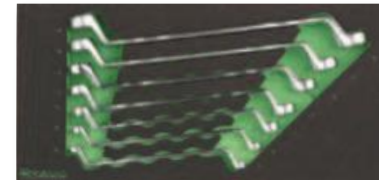

CODE	€/Pz
FG 100/07C	105,00
FG TER 100/07C	24,00

FG 615/B6x7, 8x9, 10x11, 12x13, 14x15, 16x17, 18x19mm

1/3		
-----	--	--

## 5 double ended offset wrenches form

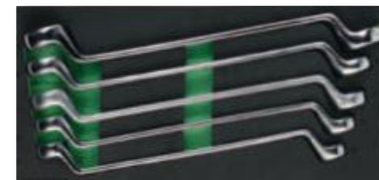

CODE	€/Pz
FG 100/07D	145,00
FG TER 100/07D	24,00

FG 615/B20x22, 21x23, 24x27, 25x28, 30x32mm

1/3		
-----	--	--

## 12 THandle wrenches form

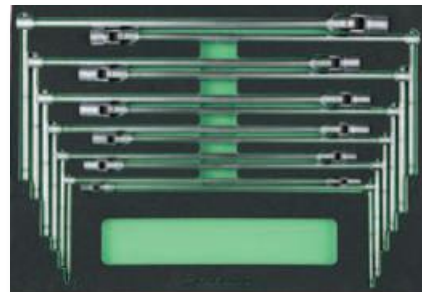

CODE	€/Pz
FG 100/10D	523,00
FG TER 100/10D	70,00

FG 618/A7, 8, 10, 11, 12, 13, 14, 15, 16, 17, 18, 19 mm

1/1		
-----	--	--

## 6 THandle male wrenches form

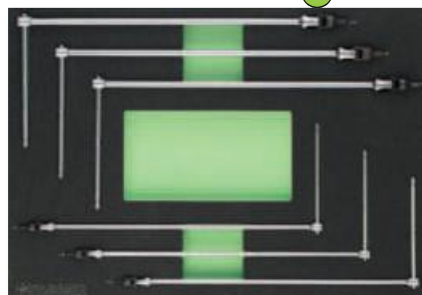

CODE	€/Pz
FG 100/10H	294,00
FG TER 100/10H	70,00

FG 619/H3, 4, 5, 6, 8, 10 mm

1/1		
-----	--	--

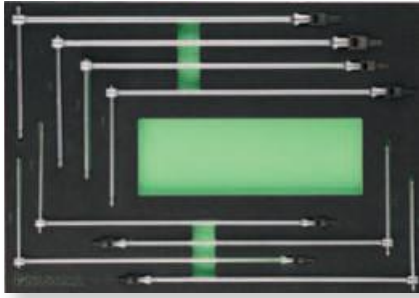

**8 THandle male wrenches form-TX**

CODE	€/Pz
FG 100/10TX	<b>406,00</b>
FG TER 100/10TX	<b>70,00</b>

FG 619/TX20,25,27,30,40,45,50,55

1/1



**10 pipe wrenches -6PTx12PT**

CODE	€/Pz
FG 100/13C	<b>193,60</b>
FG TER 100/13C	<b>24,00</b>

FG 613/A6,7,8,10,11,12,13,14,17,19mm

1/3

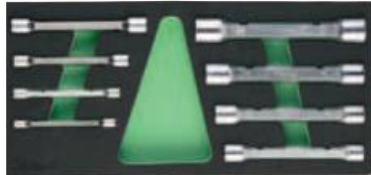

**8 tube wrenches - Heavy duty model**

CODE	€/Pz
FG 100/12B	<b>171,30</b>
FG TER 100/12B	<b>24,00</b>

FG 614/A6x7,8x9,10x11,12x13,14x15,16x17,18x19,20x22

1/3



**9 combination wrenches form-inch**

CODE	€/Pz
FG 100/03IN	<b>122,50</b>
FG TER 100/03IN	<b>24,00</b>

FG 600/IN1/4", 5/16", 3/8", 7/16", 1/2", 9/16", 5/8", 11/16", 3/4"

1/3



1/4"

**6PT socket wrenches form**

CODE	€/Pz
FG 100/17E	<b>285,00</b>
FG TER 100/17E	<b>24,00</b>

1/3



1/4"

**6PT socket wrenches form**

CODE	€/Pz
FG 100/17	<b>135,00</b>
FG TER 100/17	<b>24,00</b>

1/3

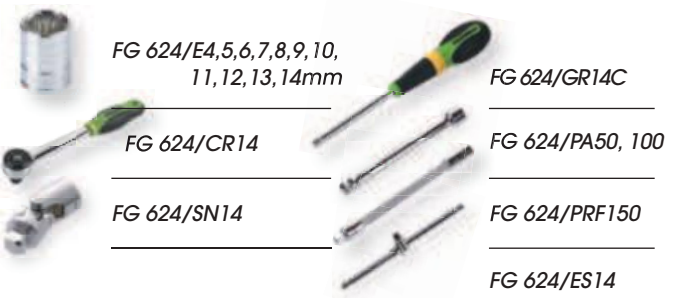

FG 624/E4,5,6,7,8,9,10,11,12,13,14mm

FG 624/GR14C

FG 624/CR14

FG 624/PA50, 100

FG 624/SN14

FG 624/PRF150

FG 624/ES14



1/4"

**6PT socket wrenches form**

CODE	€/Pz
FG 100/17IN	<b>164,40</b>
FG TER 100/17IN	<b>24,00</b>

1/3

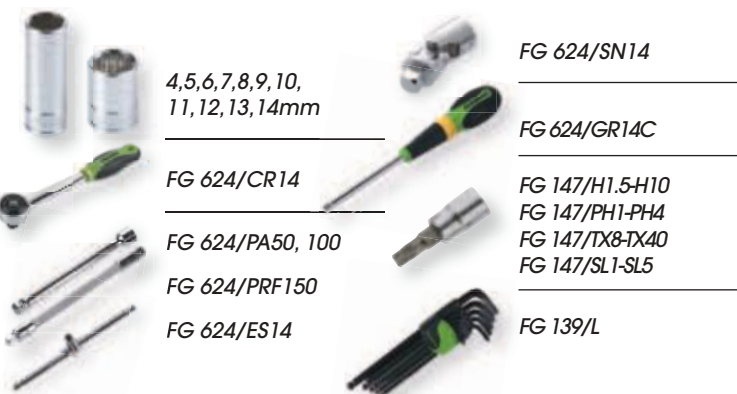

4,5,6,7,8,9,10,11,12,13,14mm

FG 624/SN14

FG 624/CR14

FG 624/GR14C

FG 624/PA50, 100

FG 147/H1.5-H10

FG 624/PRF150

FG 147/PH1-PH4

FG 624/ES14

FG 147/TX8-TX40

FG 147/SL1-SL5

FG 139/L

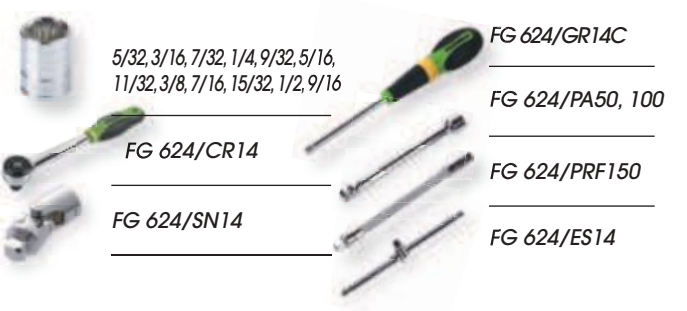

5/32, 3/16, 7/32, 1/4, 9/32, 5/16, 11/32, 3/8, 7/16, 15/32, 1/2, 9/16

FG 624/GR14C

FG 624/CR14

FG 624/PA50, 100

FG 624/SN14

FG 624/PRF150

FG 624/ES14





**6PT socket wrenches form**

CODE	€/Pz
FG 100/18	295,00
FG TER 100/18	24,00

1/3 3/8<sup>SP</sup>



FG 624/B8, 9, 10, 11, 12, 13, 14, 15, 16, 17, 18, 19, 21 mm

FG 624/CR38

FG 624B/PA75, 100, 125, 250



FG 624/SN38

FG 624/ES38



**6PT socket wrenches form**

CODE	€/Pz
FG 100/19	220,00
FG TER 100/19	24,00

1/3 3/8<sup>SP</sup>

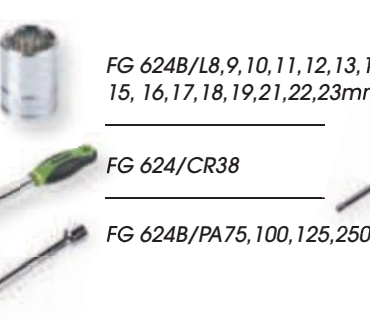

FG 624B/L8, 9, 10, 11, 12, 13, 14, 15, 16, 17, 18, 19, 21, 22, 23mm

FG 624/CR38

FG 624B/PA75, 100, 125, 250



FG 624/SN38

FG 624/ES38

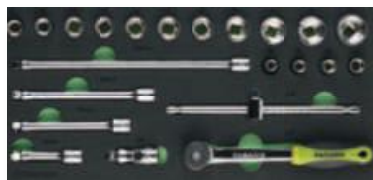

**6PT socket wrenches form**

CODE	€/Pz
FG 100/19IN	220,00
FG TER 100/19IN	24,00

1/3 3/8<sup>SP</sup>



1/4", 5/16", 11/32", 3/8", 7/16", 15/32", 1/2", 9/16", 19/32", 5/8", 11/16", 3/4", 25/3", 13/16", 7/8", 15/16"

FG 624/CR38

FG 624B/PA75, 100, 125, 250



FG 624/SN38

FG 624/ES38



**12PT socket wrenches form**

CODE	€/Pz
FG 100/18B	250,00
FG TER 100/18B	24,00

1/3 3/8<sup>SP</sup>

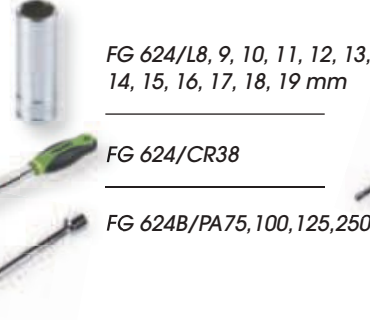

FG 624/L8, 9, 10, 11, 12, 13, 14, 15, 16, 17, 18, 19 mm

FG 624/CR38

FG 624B/PA75, 100, 125, 250



FG 624/SN38

FG 624/ES38



**12PT socket wrenches form**

CODE	€/Pz
FG 100/19B	200,00
FG TER 100/19B	24,00

1/3 3/8<sup>SP</sup>

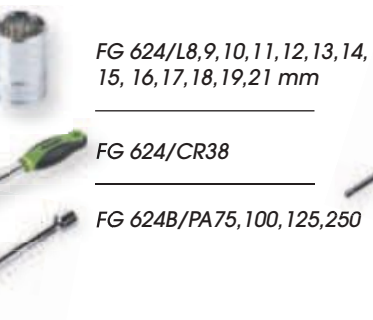

FG 624/L8, 9, 10, 11, 12, 13, 14, 15, 16, 17, 18, 19, 21 mm

FG 624/CR38

FG 624B/PA75, 100, 125, 250



FG 624/SN38

FG 624/ES38



**6PT socket wrenches form**

CODE	€/Pz
FG 100/21B	240,00
FG TER 100/21B	24,00

1/3 1/2<sup>SP</sup>

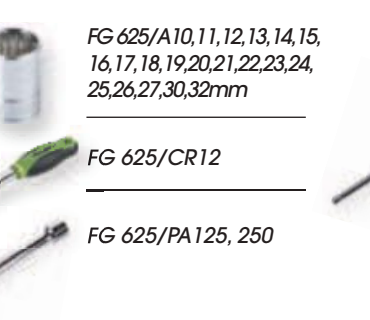

FG 625/A10, 11, 12, 13, 14, 15, 16, 17, 18, 19, 20, 21, 22, 23, 24, 25, 26, 27, 30, 32mm

FG 625/CR12

FG 625/PA125, 250



FG 625/SN12

FG 625/ES12



**12PT socket wrenches form**

CODE	€/Pz
FG 100/21C	240,00
FG TER 100/21C	24,00

1/3   **1/2"**



**12PT socket wrenches form**

CODE	€/Pz
FG 100/21D	159,00
FG TER 100/21D	24,00

1/3   **1/2"**

FG 625/C10, 11, 12, 13, 14, 15, 16, 17, 18, 19, 20, 21, 22, 23, 24, 25, 26, 27, 30, 32mm

FG 625/SN12

FG 625/CR12

FG 625/ES12

FG 625/PA125, 250

FG 625/C8, 10, 12, 13, 15, 17, 19, 21, 24, 27, 30, 32mm

FG 625/SN12

FG 625/CR12

FG 625/ES12

FG 625/PA125

**1/2"**

**6PT socket wrenches form**

CODE	€/Pz
FG 100/21M	159,00
FG TER 100/21M	24,00

1/3



**6PT socket wrenches form**

CODE	€/Pz
FG 100/21E	410,00
FG TER 100/21E	35,00

1/2

**1/4" 1/2"**

FG 625/A8, 10, 12, 13, 15, 17, 19, 21, 24, 27, 30, 32mm

FG 625/SN12

FG 625/CR12

FG 625/ES12

FG 625/PA125

**1/2"**

**6PT socket wrenches form**

CODE	€/Pz
FG 100/21N	260,00
FG TER 100/21N	24,00

1/3

**1/4" 1/2"**

**6PT socket wrenches form**

CODE	€/Pz
FG 100/21G	330,00
FG TER 100/21G	24,00

1/3

5/16", 3/8", 7/16", 15/32", 1/2", 9/16", 19/32", 5/8", 11/16", 3/4", 25/32", 13/16", 7/8", 15/16", 1", 1.1/16", 1.3/16", 1.1/4"

FG 625/SN12

FG 625/CR12

FG 625/ES12

FG 625/PA125, 250

**6PT socket wrenches form**

1/2   **1/2"**







1/4" 1/2"



### Torx tools form

CODE	€/Pz
FG 100/21TX	255,00
FG TER 100/21TX	24,00

1/3



FG 624/TX4 - TX10

FG 150/TX10 - TX60

FG 625/TX8 - TX24

FG 138/C

FG 147/TX9 - TX40

1/2"



### 19 impact socket wrenches form

CODE	€/Pz
FG 100/23B	360,00
FG TER 100/23B	35,00

FG 628/L10, 11, 12, 13, 14, 15, 16, 17, 18, 19, 21, 22, 23, 24, 25, 27, 29, 30, 32mm

1/3

1/2"



### 20 impact socket wrenches form

CODE	€/Pz
FG 100/23C	220,00
FG TER 100/23C	24,00

FG 628/C10, 11, 12, 13, 14, 15, 16, 17, 18, 19, 20, 21, 22, 23, 24, 25, 26, 27, 30, 32mm

1/3

### 6PT socket wrenches form



CODE	€/Pz
FG 100/25	420,00
FG TER 100/25	35,00

2/3

3/4"

34,36,41,46,50mm

FG 629/CR34

FG 625/SN12

FG 629/ES34

FG 629/PR200

### 12PT socket wrenches form

CODE	€/Pz
FG 100/25B	420,00
FG TER 100/25B	35,00

2/3

3/4"

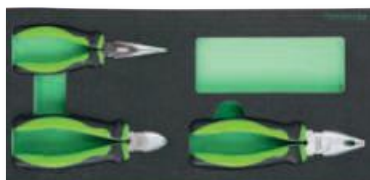

### 3 pliers form

CODE	€/Pz
FG 100/39XT	104,00
FG TER 100/39XT	24,00

FG 59/XT180 - FG 61/XT160  
FG 63/XT160

1/3

**NEW**



### 3 pliers form

CODE	€/Pz
FG 100/39C	95,00
FG TER 100/39C	24,00

FG 59SR/180, FG 60SR/160,  
FG 63SR/160

1/3

### 4 circlip pliers form



CODE	€/Pz
FG 100/41C	110,00
FG TER 100/41C	24,00

FG 51/140, FG 52/140,  
FG 53/140, FG 54/140

1/3

**4 circlip  
pliers form**



CODE	€/Pz
FG 100/42C	112,00
FG TER 100/42C	24,00

FG 51/180, FG 52/180,  
FG 53/180, FG 54/180

1/3		
-----	--	--

**1/4"dr. bits form**



CODE	€/Pz
FG 100/48D	110,00
FG TER 100/48D	14,00



1/6		
-----	--	--

**10mm dr. bits form**

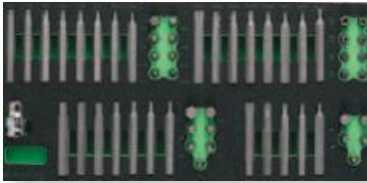

CODE	€/Pz
FG 100/48G	130,00
FG TER 100/48G	24,00



1/3		
-----	--	--

**6 screwdrivers form**



CODE	€/Pz
FG 100/45D	65,00
FG TER 100/45D	24,00

FG 22/3x100, 4x125, 5.5x200, 6.5x150  
FG 22/PH1x80, PH2x150

1/3		
-----	--	--

**7 screwdrivers form**

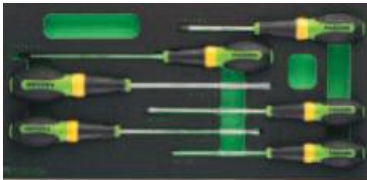

CODE	€/Pz
FG 100/45G	68,00
FG TER 100/45G	24,00

2.5x60, 3x100, 3.5x100, 4x125  
5.5x150, 5.5x100, 6.5x150

1/3		
-----	--	--

**5 screwdrivers  
form**

FG 22/2.5x300, 4x400, 5.5x400  
FG 22/PH1x400, PH2x400

1/2		
-----	--	--

CODE	€/Pz
FG 100/45H	80,00
FG TER 100/45H	48,00



**8 screwdrivers form**

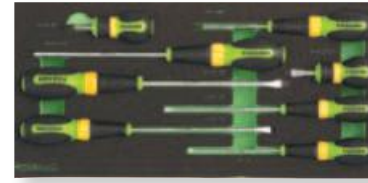

CODE	€/Pz
FG 100/45E	78,00
FG TER 100/45E	24,00

3x100, 4x125, 5.5x150, 6.5x150,  
6.5x38, PH1x80, PH2x150, PH2x38

1/3		
-----	--	--

**6 screwdrivers form**



CODE	€/Pz
FG 100/45F	68,00
FG TER 100/45F	24,00

PH0x60, PH1x150, PH2x100,  
PH2x150, PH3x150, PH2x38

1/3		
-----	--	--

**6 screwdrivers form**

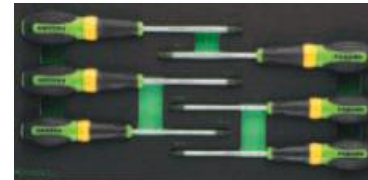

CODE	€/Pz
FG 100/45I	80,00
FG TER 100/45I	24,00

TX10, TX15, TX20,  
TX25, TX27, TX30

1/3		
-----	--	--

**6 screwdrivers form**

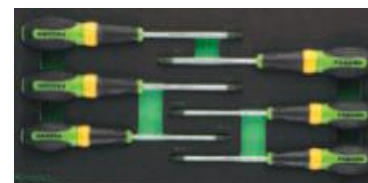

CODE	€/Pz
FG 100/45L	84,00
FG TER 100/45L	24,00

RTX10, RTX15, RTX20,  
RTX25, RTX27, RTX30

1/3		
-----	--	--





## 6 screwdrivers form

CODE	€/Pz
FG 100/45M	<b>70,80</b>
FG TER 100/45M	<b>24,00</b>

FG 22/H2.5, 3, 4, 5, 6, 8 mm

1/3		
-----	--	--

**NEW**

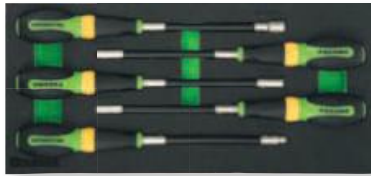

## 5 screwdrivers form

CODE	€/Pz
FG 100/45Q	<b>129,00</b>
FG TER 100/45Q	<b>24,00</b>

FG 22/FL 5, 6, 7, 8, 10 mm

1/3		
-----	--	--

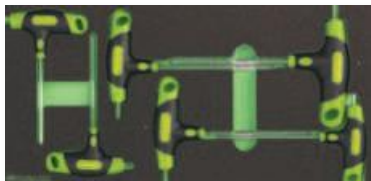

## Hex Handle wrenches form

CODE	€/Pz
FG 100/50F	<b>90,00</b>
FG TER 100/50F	<b>24,00</b>

FG 142/2, 2.5, 3, 4, 5, 6

1/3		
-----	--	--



## Form for car body repair shops

CODE	€/Pz
FG 100/53	<b>310,00</b>
FG TER 100/53	<b>35,00</b>

FG 130/TP, FG 130/TQ, FG 130/TZQ,  
FG 130/TPP, FG 131/TR, FG 131/TV, FG 131/TB

1/2	
-----	--



## Hex Handle wrenches form

CODE	€/Pz
FG 100/51H	<b>140,00</b>
FG TER 100/51H	<b>24,00</b>

FG 621/H2, 2.5, 3, 4, 5, 6, 8mm

1/3		
-----	--	--

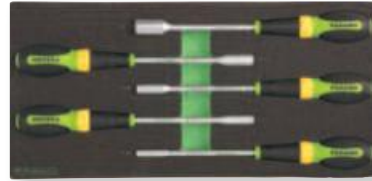

## 5 screwdrivers form

CODE	€/Pz
FG 100/45T	<b>85,00</b>
FG TER 100/45T	<b>24,00</b>

FG 22/FX6, FX7, FX8, FX10, FX13

1/3		
-----	--	--



## Hex Handle wrenches form

CODE	€/Pz
FG 100/50E	<b>200,00</b>
FG TER 100/50E	<b>48,00</b>

FG 142/2-10  
FG 138

2/3			
-----	--	--	--

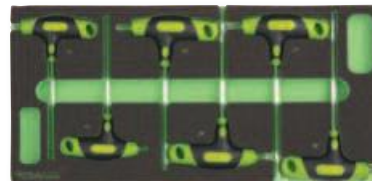

## Torx Handle wrenches form

CODE	€/Pz
FG 100/50G	<b>90,00</b>
FG TER 100/50G	<b>24,00</b>

FG 143/TX10, TX15, TX20, TX25, TX27, TX30

1/3		
-----	--	--



## Form for car body repair shops

CODE	€/Pz
FG 100/53B	<b>570,00</b>
FG TER 100/53B	<b>35,00</b>

FG 130/TP, FG 130/TQ, FG 131/TB,  
FG 131/TC, FG 131/TV, FG 131/SC,  
FG 131/SCZ, FG 131/PL.12, FG 136/30

1/2	
-----	--



**NEW**

**8 bodywork tools form**

CODE	€/Pz
FG 100/52A	<b>184,00</b>
FG TER 100/52A	<b>35,00</b>

FG 185/A1, A2, A3, A4, A5, A6, A7, A8

2/3

**NEW**

**5 vehicle windows tools form**

CODE	€/Pz
FG 100/52C	<b>151,00</b>
FG TER 100/52C	<b>24,00</b>

FG 187/IM - FG 187/W50  
FG 187/GU2 - FG 187/GR

1/3

**NEW**

**5 plastic wedges form**

CODE	€/Pz
FG 100/52E	<b>89,00</b>
FG TER 100/52E	<b>24,00</b>

FG 188P/S2 - FG 184P/S3

1/3

**NEW**

**5 bodywork tools form**

CODE	€/Pz
FG 100/52G	<b>122,00</b>
FG TER 100/52G	<b>24,00</b>

FG 185/RM - FG 185/CR - FG 189/PO1  
FG 182/RG10 - FG 183/RV1

**5 bodywork tools form**

CODE	€/Pz
FG 100/68	<b>120,00</b>
FG TER 100/68	<b>24,00</b>

FG 186/S5

1/3

**NEW**

**Percussion tools form**

CODE	€/Pz
FG 100/55/B	<b>114,00</b>
FG TER 100/55B	<b>24,00</b>

FG 135/45 - FG 136-40

1/3

**NEW**

**26 bodywork cutting tools form**

CODE	€/Pz
FG 100/52B	<b>166,00</b>
FG TER 100/52B	<b>24,00</b>

FG 183/CM - FG 183CM/S3  
FG 183/CK250 - FG 183/CK-R  
FG 183/RA1 - FG 183RA/S10

1/3

**NEW**

**10 nylon levers form**

CODE	€/Pz
FG 100/52D	<b>103,00</b>
FG TER 100/52D	<b>24,00</b>

FG 185P/S4 - FG 188/P1 - FG 186P/S5

1/3

**NEW**

**5 steel scrapers form**

CODE	€/Pz
FG 100/52F	<b>111,00</b>
FG TER 100/52F	<b>24,00</b>

FG 184R/S3 - FG 184/R1 - FG 184/R2

1/3

**NEW**

**bodywork tools form**

CODE	€/Pz
FG 100/52H	<b>232,00</b>
FG TER 100/52H	<b>70,00</b>

FG 47/S3 - FG 48/L - FG 48/KL10  
FG 22XL/TX10 - FG 22XL/TX15  
FG 22XL/TX20 - FG 22XL/TX25  
- FG 22XL/TX27

1/1

**Percussion tools form**

CODE	€/Pz
FG 100/56C	<b>130,00</b>
FG TER 100/56C	<b>15,00</b>

FG 132/500, FG 136/40  
FG 126/SN1, FG 126/SN3

1/3



## Measuring tools form



CODE	€/Pz
FG 100/54	160,00
FG TER 100/54	24,00

FG 95/CA, FG 188/2, FG 95/M1, FG 81/PT1, FG 44/MT5

1/3		
-----	--	--

## Adjustable pliers form



CODE	€/Pz
FG 100/65C	125,50
FG TER 100/65C	24,00

FG 70/CJ250 - FG 58/A240  
FG 49/HE250

1/3		
-----	--	--



## Oil filter plugs and wrenches form



CODE	€/Pz
FG 100/76C	274,00
FG TER 100/76C	24,00

FG 176/FO1 - FG 176/RE  
FG 175/S15



1/3		
-----	--	--



CONTENT	
	8,10, 12, 14, 17 mm
	13, 14, 17, 18, 19, 21mm
	TX45

## Adjustable pliers form

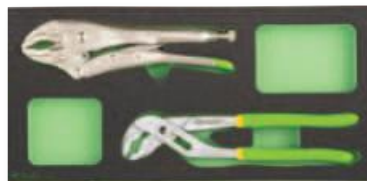

CODE	€/Pz
FG 100/65B	78,00
FG TER 100/65B	24,00

FG 58/B240  
FG 69/CJ250

1/3		
-----	--	--

## 5 second cut files form



CODE	€/Pz
FG 100/62B	95,00
FG TER 100/62B	24,00

FG 80/8AR, FG 80/8AM,  
FG 80/8AP, FG 80/8AT, FG 80/8AQ

1/3		
-----	--	--

## Socket bit wrenches form



CODE	€/Pz
FG 100/81F	200,00
FG TER 100/81F	24,00

FG 150/H2-H8, FG 150L/H2-H8  
FG 150/M5-M16, FG 150L/M5-M14

1/3		
-----	--	--

## Socket bit wrenches form-RIBE



CODE	€/Pz
FG 100/82B	170,00
FG TER 100/82B	24,00

FG 150/R4-R14, FG 150L/R4-R14  
FG 150/R4-R14, FG 150L/R4-R14

1/3		
-----	--	--

## Empty form for pieces



CODE	€/Pz
FG 100/VA1	24,00

1/3		
-----	--	--

## Empty form for pieces



CODE	€/Pz
FG 100/VA2	14,00

1/6		
-----	--	--

## Empty form for pieces



CODE	€/Pz
FG 100/VA3	24,00

1/3		
-----	--	--

## Empty form for pieces



CODE	€/Pz
FG 100/VA4	21,00

1/6		
-----	--	--

## Assortment of 161 tools

CODE	€/Pz
FG 100/AS161	1.319,00

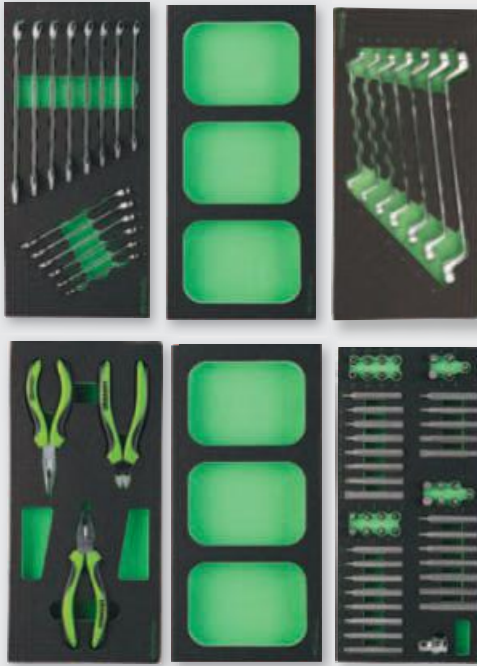

- **FG 100/03G**: 14 pcs combination wrenches form
- **FG 100/VA1**: Empty form for pieces
- **FG 100/07C**: 7 double ended offset wrenches form
- **FG 100/39C**: 3 pliers form
- **FG 100/VA1**: Empty form for pieces
- **FG 100/48G**: 10mm dr. bits form

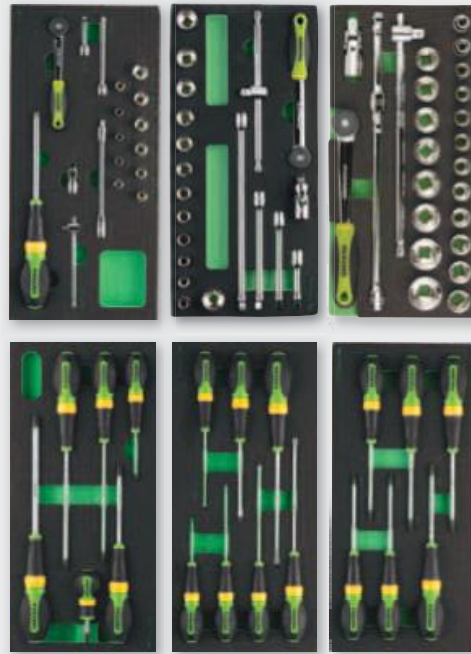

- **FG 100/17**: 6 PT socket wrenches form
- **FG 100/19**: 6 PT socket wrenches form
- **FG 100/21B**: 6 PT socket wrenches form
- **FG 100/45F**: 6 screwdrivers form
- **FG 100/45G**: 7 screwdrivers form
- **FG 100/45I**: 6 screwdrivers form

## Assortment of 226 tools

CODE	€/Pz
FG 100/AS226	1.698,00

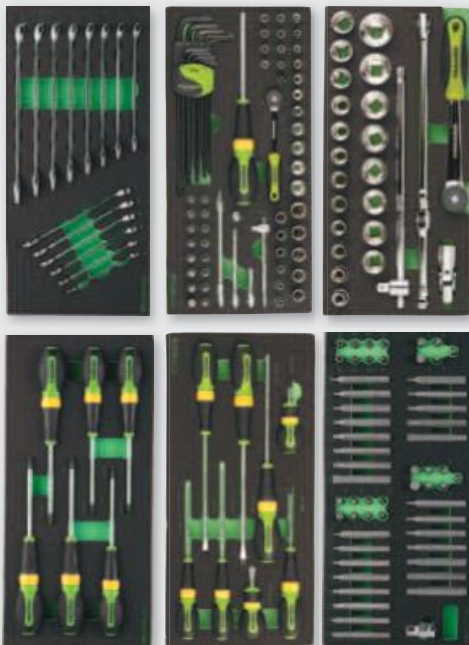

- **FG 100/03G**: 14 pcs combination wrenches form
- **FG 100/17E**: 6 PT socket wrenches form
- **FG 100/21B**: 6 PT socket wrenches form
- **FG 100/39C**: 3 pliers form
- **FG 100/VA1**: Empty form for pieces
- **FG 100/21TX**: Torx tools form



- **FG 100/45I**: 6 screwdrivers form
- **FG 100/45E**: 8 screwdrivers form
- **FG 100/48G**: 10mm dr. bits form
- **FG 100/10C**: 8 T-Handle wrenches form





## 1° drawer

- **FG 100/03G:** 14pcs combination wrenches form
- **FG 100/VA1:** Empty form for pieces
- **FG 100/03E:** 8pcs double open end wrenches form

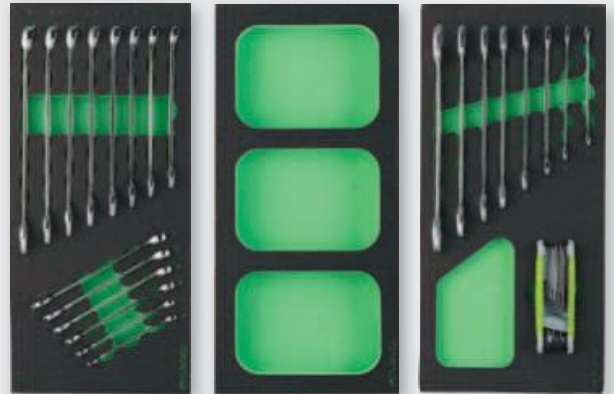

## Assortment of 173 tools

CODE	€/Pz
FG 100/AS173	1.885,00

## 2° drawer

- **FG 100/17:** 6pt socket wrenches form
- **FG 100/21TX:** Torx tools form
- **FG 100/21B:** 6pt socket wrenches form

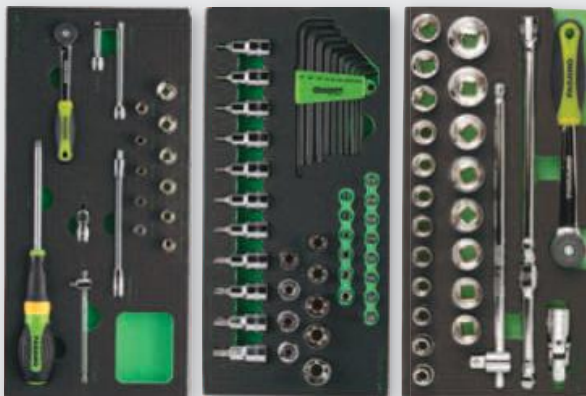

## 3° drawer

- **FG 100/81F:** Socket bit wrenches form
- **FG 100/42C:** 4 circlip pliers form
- **FG 100/65B:** Adjustable pliers form



## 4° drawer

- **FG 100/39C:** 3 pliers form
- **FG 100/45D:** 6 screwdrivers form
- **FG 100/45I:** 6 screwdrivers form



## 5° drawer

- **FG 100/10C:** 8 T-Handle wrenches form

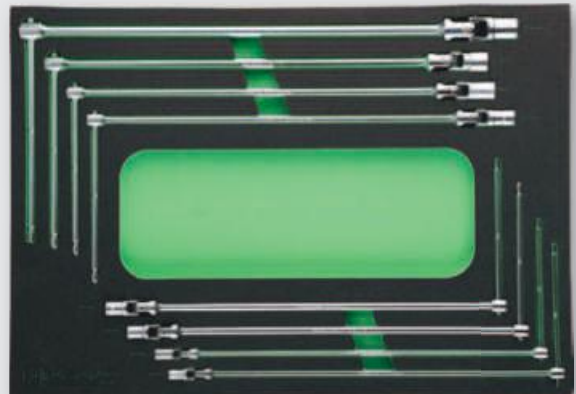

**1°drawer**

- **FG 100/03G:** 14pcs combination wrenches form
- **FG 100/VA1:** Empty form for pieces
- **FG 100/03L:** 6pcs combination wrenches form

**Assortment of 230 tools**

CODE	€/Pz
FG 100/AS230	2.253,00



**2°drawer**

- **FG 100/17E:** 6pt socket wrenches form
- **FG 100/21TX:** Torx tools form
- **FG 100/21B:** 6pt socket wrenches form



**3°drawer**

- **FG 100/81F:** Socket bit wrenches form
- **FG 100/23C:** 20 impact socket wrenches form
- **FG 100/56C:** Percussion tools form



**4°drawer**

- **FG 100/39C:** 3 pliers form
- **FG 100/45E:** 8 screwdrivers form
- **FG 100/45I:** 6 screwdrivers form



**5°drawer**

- **FG 100/10C:** 8 T-Handle wrenches form

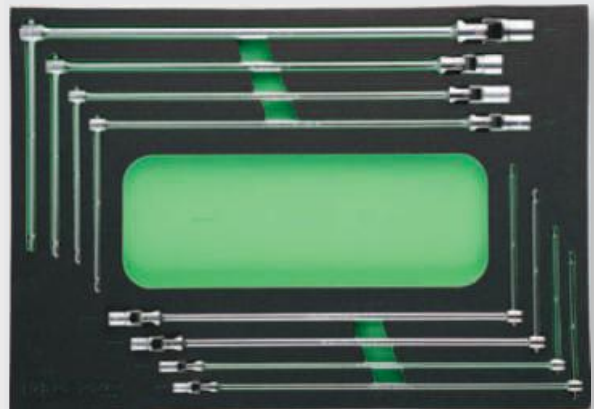



## Assortment of 248 tools

CODE	€/Pz
FG 100/AS248	2.672,00



- **FG 100/03G:** 14pcs combination wrenches form
- **FG 100/03L:** 6 pcs combination wrenches form
- **FG 100/VA4:** Empty form for pieces
- **FG 100/21H:** 6PT socket wrenches form
- **FG 100/17E:** 6PT socket wrenches form
- **FG 100/21TX:** Torx tools form
- **FG 100/81F:** Socket bit wrenches form
- **FG 100/23C:** 20 impact socket wrenches form

- **FG 100/42C:** 4 circlip pliers form
- **FG 100/39C:** 3 pliers form
- **FG 100/45E:** 8 screwdrivers form
- **FG 100/45I:** 6 screwdrivers form
- **FG 100/65B:** Adjustable pliers form
- **FG 100/10D:** 12 T-Handle wrenches form

## Assortment of 360 tools

NEW

CODE	€/Pz
FG 100/AS360	2.694,00



- **FG 100/03G:** 14 combination WRENCHES FG 600 / B 6 - 19mm form
- **FG 100/03L:** 6 combination wrenches module
- **FG 100/03E:** 8 open ended spanners module
- **FG 100/17E:** 65 tools 1/4" form
- **FG 100/21H:** Tool form with square fitting 1/2"
- **FG 100/VA4:** Empty form for small parts
- **FG 100/21TX:** Torx tool form with 1/4" and 1/2"
- **FG 100/81F:** Form with hexagonal and xzn sockets with 1/2"
- **FG 100/82B:** Ribe socket inserts form with 1/2"

- **FG 100/56C:** Percussion tool form
- **FG 100/39C:** 3 pliers form with two-material coated handles
- **FG 100/42C:** 4 pliers form for elastic rings
- **FG 100/45G:** 7 screwdrivers form with slotted head
- **FG 100/45F:** 6 screwdrivers form with cross head phillips
- **FG 100/45I:** 6 screwdrivers form with torx impression head
- **FG 100/50E:** Male hex and torx wrenche form
- **FG 100/48G:** 52 inserts form with attachment 10mm + adapter

## Assortment of 304 tools

CODE	€/Pz
FG 100/AS304	2.703,00



- **FG 100/03G**: 14pcs combination wrenches form
- **FG 100/03L**: 6 pcs combination wrenches form
- **FG 100/21H**: 6PT socket wrenches form.
- **FG 100/17E**: 6PT socket wrenches form
- **FG 100/21TX**: Torx tools form
- **FG 100/VA4**: Empty form for pieces
- **FG 100/81F**: Socket bit wrenches form
- **FG 100/23C**: 20 impact socket wrenches form

- **FG 100/48G**: 10mm dr. bits form
- **FG 100/45I**: 6 screwdrivers form
- **FG 100/45T**: 6 screwdrivers form
- **FG 100/45E**: 8 screwdrivers form
- **FG 100/65B**: Adjustable pliers form
- **FG 100/39C**: 3 pliers form
- **FG 100/50F**: Hex T-Handle wrenches form
- **FG 100/10C**: 8 T-Handle wrenches form

## Assortment of 56 tools

CODE	€/Pz
FG 100/AS56	1.877,20



- **FG 100/21-IS**: Set of insulated simple wrench and screwdrivers
- Insulated simple wrenches 7-19mm
- Insulated slotted screwdrivers 2.5x75mm, 3x100mm, 5.5x125mm, 6.5x150mm, 8x175mm
- Insulated Phillips screwdrivers PH0x60, PH1x80, PH2x100, PH3x150
- **FG 100/03-IS**: Set of 1/2" insulated socket wrenches
- 1/2" dr hex socket wrenches 10-32mm
- 1/2" dr. hex socket bits 4-10mm
- 1/2" dr. accessories
- **FG 100/39-IS**: Set of insulated pliers and cutting tools
- Insulated pliers and diagonal cutting pliers
- Electrician's scissor
- Insulated cutter
- Wire stripping

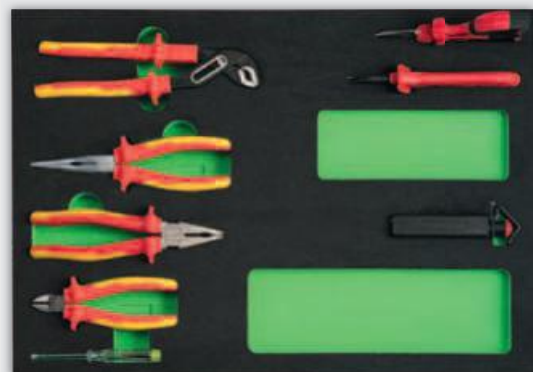
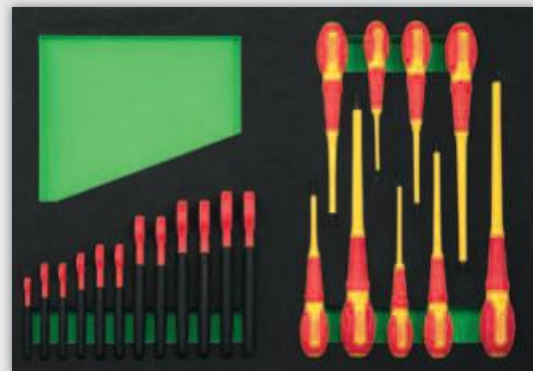



Assortment of 171 tools for car body shop

NEW

CODE	€/Pz
FG 100/AS171	1.789,00

## 1° drawer

- FG 100/03G: 14pcs combination wrenches form
- FG 100/17E: 6PT socket wrenches tray
- FG 100/39C: 3 pliers form



## 2° drawer

- FG 100/45I: 6 screwdrivers form
- FG 100/52F: General maintenance tool module for bodywork
- FG 100/52G: General maintenance tool module for bodywork



## 3° drawer

- FG 100/52A: Module 8 nipple remover
- FG 100/52B: Bodywork cutting tools module
- FG 100/VA4: Filling module with compartments for small parts



## 4° drawer

- FG 100/52C: Vehicle window tool module
- FG 100/52D: Nylon lever module
- FG 100/52E: Plastic wedges module



## 5° drawer

- FG 100/52H: General maintenance tool module for bodywork



**Assortment of 284 tools  
for car body shop**

**NEW**

CODE	€/Pz
FG 100/AS284	2.920,00

**1° drawer**

**2° drawer**

- **FG 100/03G:** Module 14 combination wrenches 6 - 19mm
- **FG 100/17E:** Module 65 tools 1/4 "
- **FG 100/21TX:** Module 44 TORX tools
- **FG 100/45F:** Module 6 Phillips screwdrivers
- **FG 100/45I:** Module 6 screwdrivers TORX
- **FG 100/45T:** Module 6 hexagonal socket screwdrivers
- **FG 100/56C:** Percussion tools module
- **FG 100/81F:** Socket module 1/2 "hex and" XZN "



**3° drawer**

- **FG 100/21M:** Socket hexagonal module
- **FG 100/39C:** Module with 3 assorted pliers
- **FG 100/50G:** Module with 6 male Torx keys
- **FG 100/68:** Modul or 5 nipple removers

**4° drawer**

- **FG 100/52A:** 7 nipple removers
- **FG 100/52B:** Bodywork cutting tools module
- **FG 100/VA4:** Filling module with small parts compartments
- **FG 100/52C:** Tool module for vehicle windows

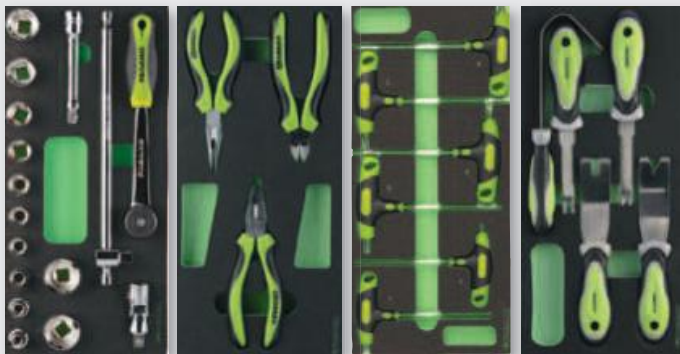

**5° drawer**

- **FG 100/52D:** Module nylon levers
- **FG 100/52E:** Plastic wedges module
- **FG 100/52F:** General maintenance tools module for bodywork
- **FG 100/52G:** General maintenance tool module for bodywork

**6° drawer**

- **FG 100/52H:** General maintenance tool module for bodywork
- **FG 100/VA1:** Filling module with compartments for small parts

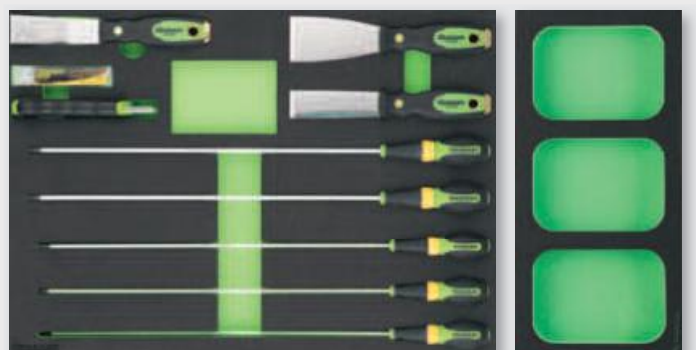



## 14 combination wrenches tray

CODE	€/Pz
FG 102/03G	135,00
FG TER 102/03G	15,00

FG 600/B6,7,8,9,10,11,12,13,14,15,16,17,18,19mm

1/3		
-----	--	--



## 18 combination wrenches tray

CODE	€/Pz
FG 102/03H	250,00
FG TER 102/03H	20,00

FG 600/B6,7,8,10,11,12,13,14,17,18,19,21,22,24,27,30,32mm

2/3		
-----	--	--



## 8 double open end wrenches tray

CODE	€/Pz
FG 102/03E	80,00
FG TER 102/03E	15,00

FG 602/B6x7,8x9,10x11,12x13,14x15,16x17,18x19,20x22mm + FG 139C/FS

1/3		
-----	--	--



## 5 double open end wrenches tray

CODE	€/Pz
FG 102/03F	92,00
FG TER 102/03F	20,00

FG 602/B21x23,24x26,25x28,27x29,30x32mm

1/3		
-----	--	--



## 6 combination wrenches tray

CODE	€/Pz
FG 102/03L	145,00

FG 600/B21,22,24,27,30,32mm



## 7 double ended offset wrenches tray

CODE	€/Pz
FG 102/07C	92,00
FG TER 102/07C	15,00

FG 615/B6x7,8x9,10x11,12x13,14x15,16x17,18x19mm

1/3		
-----	--	--



## 8 gear combination wrenches tray

CODE	€/Pz
FG 102/08C	230,00
FG TER 102/08C	15,00

FG 605/B8,10,11,12,13,14,15,16,17,18,19mm

1/3		
-----	--	--



## 5 double ended offset wrenches tray

CODE	€/Pz
FG 102/07D	135,00
FG TER 102/07D	15,00

FG 615/B20x22,21x23,24x27,25x28,30x32mm

1/3		
-----	--	--



## 8 THandle wrenches tray

CODE	€/Pz
FG 102/10C	330,00
FG TER 102/10C	24,00

FG 618/A7,8,10,11,13,14,17,19mm

1/1		
-----	--	--

1/4"



## 6PT socket wrenches tray

CODE	€/Pz
FG 102/17	125,00
FG TER 102/17	15,00

FG 615/B6x7,8x9,10x11,12x13,14x15,16x17,18x19mm

1/3		
-----	--	--



FG 624/E4,5,6,7,8,9,10,11,12,13,14mm

FG 624/CR14

FG 624/SN14



FG 624/GR14C

FG 624/PA50, 100

FG 624/PRF150

FG 624/ES14

1/4"



## 6PT socket wrenches tray

CODE	€/Pz
FG 102/17E	265,00
FG TER 102/17E	15,00

FG 605/B8,10,11,12,13,14,15,16,17,18,19mm

1/3		
-----	--	--



4,5,6,7,8,9,10,11,12,13,14mm

FG 624/CR14

FG 624/PA50, 100

FG 624/PRF150

FG 624/ES14

FG 624/SN14

FG 624/GR14C

FG 147/H1.5H10

FG 147/PH1-PH4

FG 147/TX8-TX40

FG 147/SL1-SL5

FG 139/L

3/8"



**6PT socket wrenches tray**

CODE	€/Pz
FG 102/19	200,00
FG TER 102/19	15,00

1/3

FG 624/B8,9,10,11,12,13,14,15,16,17,18,19,21,22,23mm

FG 624/SN38

FG 624/CR38

FG 624/ES38

FG 624B/PA75,100,125,250

1/2"



**6PT socket wrenches tray**

CODE	€/Pz
FG 102/21B	230,00
FG TER 102/21B	15,00

1/3

FG 625/A10,11,12,13,14,15,16,17,18,19,20,21,22,23,24,25,26,27,30,32mm

FG 625/SN12

FG 625/CR12

FG 625/ES12

FG 625/PA125, 250

1/2"



**12PT socket wrenches tray**

CODE	€/Pz
FG 102/21C	230,00
FG TER 102/21C	15,00

1/3

FG 625/C10,11,12,13,14,15,16,17,18,19,20,21,22,23,24,25,26,27,30,32mm

FG 625/SN12

FG 625/CR12

FG 625/ES12

FG 625/PA125, 250

1/2"



**12PT socket wrenches tray**

CODE	€/Pz
FG 102/21D	165,00
FG TER 102/21D	15,00

1/3

FG 625/C8, 10, 12, 13, 15, 17, 19, 21,24, 27, 30, 32mm

FG 625/SN12

FG 625/CR12

FG 625/ES12

FG 625/PA125

1/2"



**6PT socket wrenches tray**

CODE	€/Pz
FG 102/21E	165,00
FG TER 102/21E	15,00

1/3

FG 625/A8, 10, 12, 13, 15, 17, 19, 21,24, 27, 30, 32mm

FG 625/SN12

FG 625/CR12

FG 625/ES12

FG 625/PA125

1/4" 1/2"

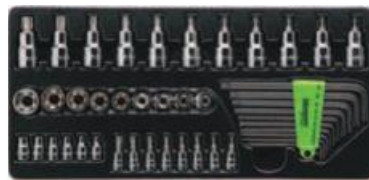

**Tray of Torx tools**

CODE	€/Pz
FG 102/21TX	235,00
FG TER 102/21TX	15,00

1/3

FG 624/TX4 - TX10

FG 150/TX10 - TX60

FG 625/TX8 - TX24

FG 138/C

FG 147/TX9 - TX40





## Socket bit wrenches tray

CODE	€/Pz
FG 102/21H	200,00
FG TER 102/21H	15,00

FG 150/H2-H8, FG 150L/H2-H8  
FG 150/M5-M16, FG 150L/M5-M16

1/3		
-----	--	--



## RIBE socket bit wrenches tray

CODE	€/Pz
FG 102/21R	220,00
FG TER 102/21R	15,00

FG 150/R4-R14, FG 150L/R4-R14  
FG 150/R4-R14, FG 150L/R4-R14

1/3		
-----	--	--



## Hex Handle wrenches tray

CODE	€/Pz
FG 102/51H	130,00
FG TER 102/51H	15,00

FG 621/H2, 2,5, 3, 4, 5, 6, 8mm

1/3		
-----	--	--



## 6PT socket wrenches tray

CODE	€/Pz
FG 102/25	395,00
FG TER 102/25	20,00

2/3		
-----	--	--



## 12PT socket wrenches tray

CODE	€/Pz
FG 102/25B	395,00
FG TER 102/25B	20,00

2/3		
-----	--	--



34,36,41,46,50mm

FG 629/CR34

FG 625/SN12

FG 629/ES34

FG 629/PR200

## Impact socket wrenches tray

CODE	€/Pz
FG 102/23C	145,50
FG TER 102/23C	15,00

FG 628/C10, 11, 12, 13, 14, 16, 17, 18,  
19, 21, 22, 23, 24mm + FG 628/PR125

1/3		
-----	--	--



## 10 elbowen wrench 6x12PT tray

CODE	€/Pz
FG 102/13C	175,00
FG TER 102/13C	20,00

FG 613/A6, 7, 8, 10,  
11, 12, 13, 14, 17, 19mm

1/3		
-----	--	--



## 3 pliers tray

CODE	€/Pz
FG 102/39XT	95,00
FG TER 102/39XT	15,00

FG 59/XT180 - FG 61/XT160  
FG 63XT160

1/3		
-----	--	--

**NEW**



## 3 pliers tray

CODE	€/Pz
FG 102/39C	85,00
FG TER 102/39C	15,00

FG 59SR/180, FG 60SR/160,,  
FG 63SR/160

1/3		
-----	--	--

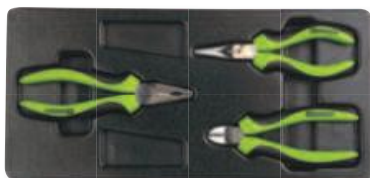

## 3 pliers tray

CODE	€/Pz
FG 102/39D	70,00
FG TER 102/39D	15,00

FG 59PV/180, FG 61PV/160,  
FG 63PV/160

1/3		
-----	--	--



## 4 circlip pliers tray

CODE	€/Pz
FG 102/41C	95,00
FG TER 102/41C	15,00

FG 51/140, FG 52/140,  
FG 53/140, FG 54/140

1/3		
-----	--	--



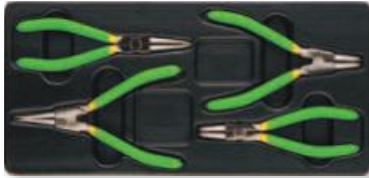

**4 circlip pliers tray**

CODE	€/Pz
FG 102/42C	100,00
FG TER 102/42C	15,00

FG 51/180, FG 52/180,  
FG 53/180, FG 54/180

1/3		
-----	--	--



**6 screwdrivers tray**

CODE	€/Pz
FG 102/45D	45,00
FG TER 102/45D	15,00

FG 22/3x100, 4x125, 5.5x150, 6.5x150  
FG 22/PH1x80, PH2x150

1/3				
-----	--	--	--	--



**8 screwdrivers tray**

CODE	€/Pz
FG 102/45E	55,00
FG TER 102/45E	15,00

3x100, 4x125, 5.5x150, 6.5x150,  
6.5x38, PH1x80, PH2x150, PH2x38

1/3				
-----	--	--	--	--



**12 screwdrivers tray**

CODE	€/Pz
FG 102/45U	90,00
FG TER 102/45U	20,00



2/3		
-----	--	--



**6 screwdrivers tray**

CODE	€/Pz
FG 102/45F	52,00
FG TER 102/45F	15,00

PH0x60, PH1x150, PH2x100,  
PH2x150, PH3x150, PH2x38

1/3			
-----	--	--	--



**6 screwdrivers tray**

CODE	€/Pz
FG 102/45I	62,00
FG TER 102/45I	15,00

TX10, TX15, TX20,  
TX25, TX27, TX30

1/3			
-----	--	--	--



**6 screwdrivers tray**

CODE	€/Pz
FG 102/45G	50,00
FG TER 102/45G	15,00

2.5x60, 3x100, 3.5x100, 4x125  
5.5x150, 5.5x100, 6.5x150

1/3			
-----	--	--	--



**6 screwdrivers tray**

CODE	€/Pz
FG 102/45L	65,00
FG TER 102/45L	15,00

TX10, TX15, TX20,  
TX25, TX27, TX30

1/3			
-----	--	--	--



**6 screwdrivers tray**

CODE	€/Pz
FG 102/45T	65,00
FG TER 102/45T	15,00

FG 22/FX6, FX7, FX8, FX10, FX13

1/3			
-----	--	--	--



**10mm dr. bits tray**

CODE	€/Pz
FG 102/48G	120,00
FG TER 102/48G	15,00



1/3		
-----	--	--



**1/4" dr. bits tray**

CODE	€/Pz
FG 102/48D	95,00
FG TER 102/48D	15,00



1/6		
-----	--	--



**Hex Handle wrenches tray**

CODE	€/Pz
FG 102/50F	76,00
FG TER 102/50F	15,00

FG 142/2, 2.5, 3, 4, 5, 6

1/3			
-----	--	--	--







## Torx Handle wrenches tray

CODE	€/Pz
FG 102/50G	76,00
FG TER 102/50G	15,00

FG 143/TX10, TX15, TX20, TX25, TX27, TX30

1/3		
-----	--	--



## Percussion tools tray

CODE	€/Pz
FG 102/56C	120,00
FG TER 102/56C	15,00

FG 132/500, FG 136/40  
FG 126/SN1, FG 126/SN3

1/3		
-----	--	--



## Measuring tools tray

CODE	€/Pz
FG 102/60C	45,00
FG TER 102/60C	15,00

FG 50/MS, FG 48/L  
FG 497/OP1, FG 44/MT5

1/3		
-----	--	--



## Adjustable pliers tray

CODE	€/Pz
FG 102/65B	65,00
FG TER 102/65B	15,00

FG 58/B240  
FG 69/C.1250

1/3		
-----	--	--



## Second cut files tray

CODE	€/Pz
FG 102/62B	90,00
FG TER 102/62B	15,00

FG 80/8AR, FG 80/8AM,  
FG 80/8AP, FG 80/8AT, FG 80/8AQ

1/3		
-----	--	--



## Emptytray for pieces

CODE	€/Pz
FG 102/VA1	15,00

1/3		
-----	--	--



## Assortment of 190 tools

CODE	€/Pz
FG 102/AS190	1.435,50



- **FG 102/03G:** 14 combination wrenches tray
- **FG 102/21B:** 6PT socket wrenches tray
- **FG 102/17E:** 6PT socket wrenches tray
- **FG 102/39D:** 3 pliers tray
- **FG 102/VA1:** Empty tray for pieces
- **FG 102/45D:** 6 screwdrivers tray
- **FG 102/48G:** 10mm dr.bits tray
- **FG 102/65B:** Adjustable pliers tray
- **FG 102/23C:** Impact socket wrenches tray
- **FG 102/10C:** 8 T-Handle wrenches tray

## Assortment of 356 tools

**NEW**

CODE	€/Pz
FG 102/AS356	2.519,00



- **FG 102/03G:** 14 combination wrenches form
- **FG 102/03L:** 6 combination wrenches rigid form
- **FG 102/03E:** 8 open-ended wrenches rigid form
- **FG 102/17E:** 6 socket wrenches rigid form 1/4"
- **FG 102/19:** Tool form with square fitting 3/8"
- **FG 102/21B:** Tool form with 1/2" square connection
- **FG 102/21TX:** Torx tool form with 1/4" and 1/2" connection
- **FG 102/21H:** Form with hexagonal and xzn sockets with 1/2"
- **FG 85/S31:** 1/4" bit set + 1/4"x1/4" holder adapter
- **FG 102/21R:** Ribe socket inserts form with 1/2" connection
- **FG 102/56C:** Percussion tool form
- **FG 102/39C:** 3 pliers form with two-material coated handles
- **FG 102/42C:** 4 pliers form for snap rings
- **FG 102/45G:** 7 screwdrivers form with slotted head
- **FG 102/45F:** 6 screwdriver form with phillips cross head
- **FG 102/45L:** 6 screwdriver form with torx
- **FG 102/48G:** 52 inserts form with 10mm connection + adapter
- **FG 102/65B:** Self-locking pliers form
- **FG 102/62B:** 5 second cut files form

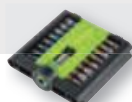

## Assortment of 149 tools

CODE	€/Pz
FG 102/AS149	1.312,00

### 1°drawer

- **FG 102/03G**: 14 combination wrenches tray
- **FG 102/VA1**: Empty tray for pieces
- **FG 102/03L**: 6 combination wrenches tray



### 2°drawer

- **FG 102/17**: 6PT socket wrenches tray
- **FG 102/19**: 6PT socket wrenches tray
- **FG 102/21B**: 6PT socket wrenches tray



### 3°drawer

- **FG 102/45E**: 8 screwdrivers tray
- **FG 102/45I**: 6 screwdrivers tray
- **FG 102/48D**: 1/4" dr. bits tray



### 4°drawer

- **FG 102/39D**: 3 pliers tray
- **FG 102/42C**: 4 circlip pliers tray
- **FG 102/65B**: Adjustable pliers tray



## Assortment of 158 tools

CODE	€/Pz
FG 102/AS158	1.504,00

### 1°drawer

- **FG 102/03G:** 14 combination wrenches tray
- **FG 102/21B:** 6PT socket wrenches tray
- **FG 102/17:** 6PT socket wrenches tray



### 2°drawer

- **FG 102/21TX:** Tray of Torx tools
- **FG 102/21H:** Socket bit wrenches tray
- **FG 102/39D:** 3 pliers tray



### 3°drawer

- **FG 102/45F:** 6 screwdrivers tray
- **FG 102/45G:** 7 screwdrivers tray
- **FG 102/45I:** 6 screwdrivers tray

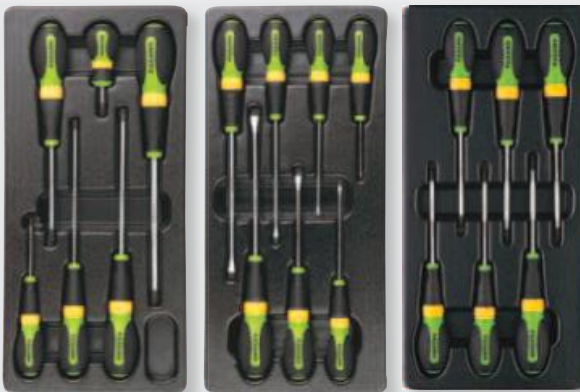

### 4°drawer

- **FG 102/10C:** 8 T-Handle wrenches tray



## Assortment of 193 tools

CODE	€/Pz
FG 102/AS193	1.462,00

### 1° drawer

- **FG 102/03G:** 14 combination wrenches tray
- **FG 102/03L:** 6 combination wrenches tray
- **FG 102/21B:** 6PT socket wrenches tray



### 2° drawer

- **FG 102/17E:** 6PT socket wrenches tray
- **FG 102/48G:** 10mm dr. bits tray
- **FG 102/45I:** 6 screwdrivers tray



### 3° drawer

- **FG 102/39D:** 3 pliers tray
- **FG 102/42C:** 4 circlip pliers tray
- **FG 102/45D:** 6 screwdrivers tray



### 4° drawer

- **FG 102/56C:** Percussion tools tray
- **FG 102/65B:** Adjustable pliers tray
- **FG 102/62B:** Second cut files tray





**Paper holder**

For FG 100, FG 102,  
FG 104, FG 105,  
FG 109, FG 160

CODE	€/Pz
FG 100/PR	62,00



**Can holder**

For FG 102, FG 103,  
FG 104, FG 105,  
FG 109, FG 160

CODE	€/Pz
FG 102/PL	58,00



**PC shelf**

For FG 102, FG 103,  
FG 104, FG 105,  
FG 109, FG 160

CODE	€/Pz
FG 102/PC	80,00



**Paper holder**

Per FG 150

CODE	€/Pz
FG 150/PR	40,00



**Can holder**

Per FG 150

CODE	€/Pz
FG 150/PL	65,00

**Rubber top**

For FG 102

CODE	€/Pz
FG 102/TG	50,00

**Rubber top**

For FG 104

CODE	€/Pz
FG 104/TG	65,00



**Can holder**

For FG 100

CODE	€/Pz
FG 100/PL	60,00



**Screwdriver holder**

For FG 102 and FG 104

CODE	€/Pz
FG 102/PA	30,00

**NEW**

**Magnetic tools' holder**

CODE	€/Pz
FG 94/MI	52,00

Dimension:  
120x94x400mm

KG  
9

MAX  
CAPACITY



**Magnetic tools' holder**

CODE	€/Pz
FG 94/MS	34,00



**Magnetic pieces holder**

CODE	€/Pz
FG 94/R	20,00

Dimension:  
165x245mm



**Magnetic pieces holder**

CODE	€/Pz
FG 94/T	17,00

Ø 150mm



## FG 128 series

MADE IN ITALY

**KG**  
2.000  
LOAD  
CAPACITY



### Workbench 2.0mt

#### TECHNICAL FEATURES:

- Upper shelf in **2mm** steel sheet;
- Lower shelf in steel sheet supplied as standard
- 6 uprights;
- Prepared for floor fixing;
- Painted structure with epoxy paint.

*Total weight: 59,5Kg*

*Static load: 2000Kg*

*Dimensions: 2.000x670x880mm*

CODE	DIMENSION	€/Pz
FG 128/2	2.000x670x880 mm	<b>700,00</b>

**NEW**

**KG**  
2.000  
LOAD  
CAPACITY



### Workbench 2.0mt with 2 drawers

#### TECHNICAL FEATURES:

- Upper shelf in **2mm** steel sheet;
- Lower shelf in steel sheet supplied as standard
- 6 uprights;
- Prepared for floor fixing;
- Painted structure with epoxy paint.

*Total weight: 74,5Kg*

*Static load: 2000Kg*

*Dimensions: 2.000x670x880mm*

**NEW**



CODE	€/Pz
FG 128/D2	<b>950,00</b>



CODE	€/Pz
FG 128/B2	<b>950,00</b>



CODE	€/Pz
FG 128/R2	<b>950,00</b>

# FG 129 series

MADE IN ITALY

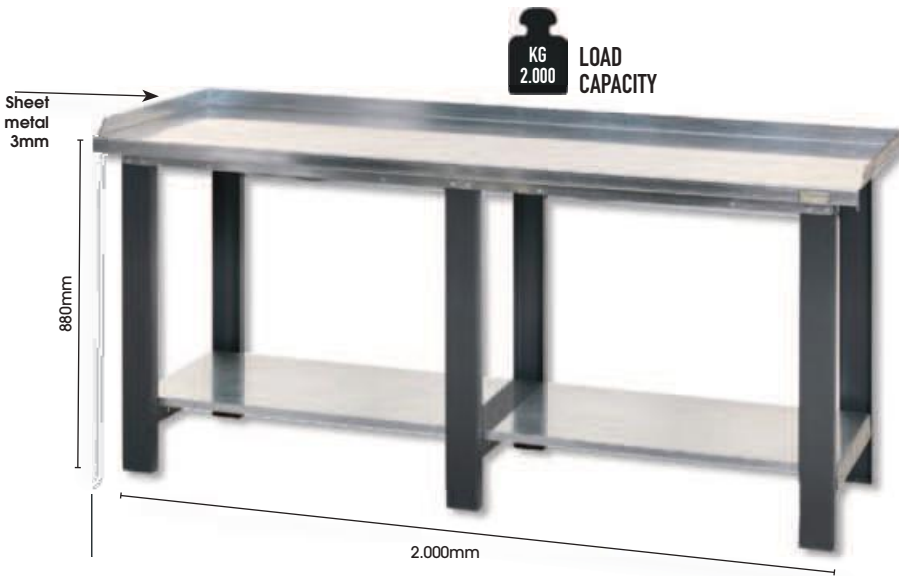

## Workbench 2.0mt

### TECHNICAL FEATURES:

- Upper shelf in **3mm** steel sheet;
- Lower shelf in steel sheet supplied as standard
- 6 uprights;
- Prepared for floor fixing;
- Painted structure with epoxy paint.

Total weight: 77Kg

Static load: 2000Kg

Dimensions: **2.000x745x880mm**

CODE	DIMENSION	€/Pz
FG 129/2	2.000x745x880 mm	<b>850,00</b>



## Workbench 2.0mt with 2 drawers

### TECHNICAL FEATURES:

- Upper shelf in **3mm** steel sheet;
- Lower shelf in steel sheet supplied as standard
- 6 uprights;
- Prepared for floor fixing;
- Painted structure with epoxy paint.

Total weight: 106,5Kg

Static load: 2000Kg

Dimensions: **2.000x745x880mm**



CODE	€/Pz
FG 129/D2	<b>1.100,00</b>



CODE	€/Pz
FG 129/B2	<b>1.100,00</b>



CODE	€/Pz
FG 129/R2	<b>1.100,00</b>





## FG 129 series

MADE IN ITALY

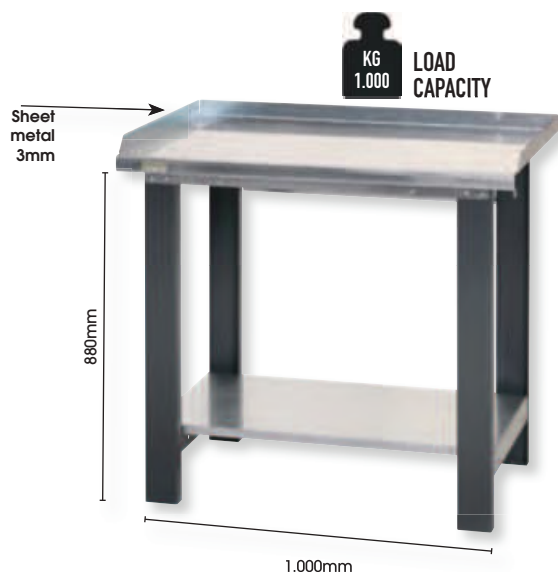

### Workbench 1.0mt

#### TECHNICAL FEATURES:

- Upper shelf in **3mm** steel sheet;
- Lower shelf in steel sheet supplied as standard
- 2 uprights;
- Prepared for floor fixing;
- Painted structure with epoxy paint.

Total weight: 58Kg

Static load: 2000Kg

Dimensions: **1.000x745x880mm**

CODE	DIMENSION	€/Pz
FG 129/1	1.000x745x880 mm	<b>550,00</b>

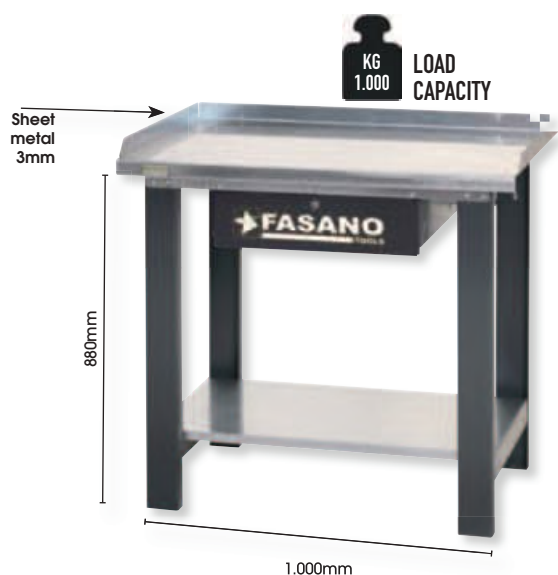

### Workbench 1.0mt with 1 drawer

#### TECHNICAL FEATURES:

- Upper shelf in **3mm** steel sheet;
- Lower shelf in steel sheet supplied as standard
- 2 uprights;
- Prepared for floor fixing;
- Painted structure with epoxy paint.

Total weight: 64,5Kg

Static load: 2000Kg

Dimensions: **1.000x745x880mm**



CODE	€/Pz
FG 129/D1	<b>690,00</b>



CODE	€/Pz
FG 129/B1	<b>690,00</b>



CODE	€/Pz
FG 129/R1	<b>690,00</b>

# FG 129 series

MADE IN ITALY

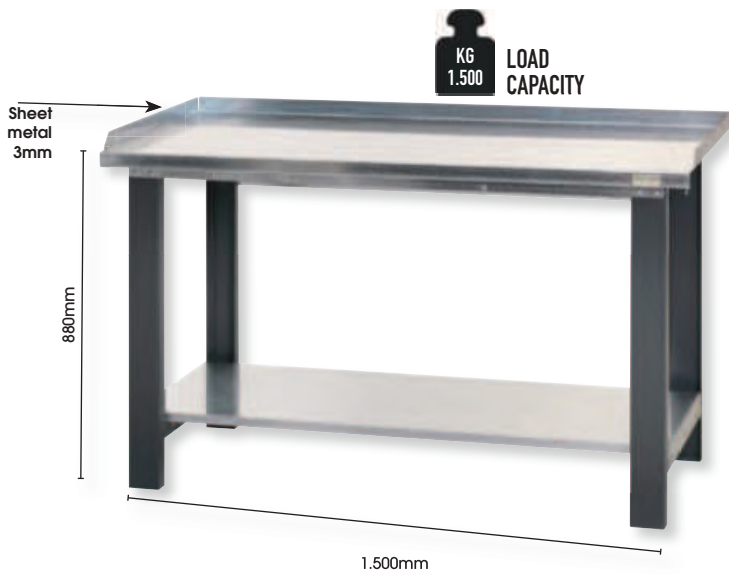

## Workbench 1.5mt

### TECHNICAL FEATURES:

- Upper shelf in **3mm** steel sheet;
- Lower shelf in steel sheet supplied as standard
- 2 uprights;
- Prepared for floor fixing;
- Painted structure with epoxy paint.

Total weight: 77Kg  
Static load: 2000Kg  
Dimensions: **1.500x745x880mm**

CODE	DIMENSION	€/Pz
FG 129/1.5	1.500x745x880 mm	<b>650,00</b>

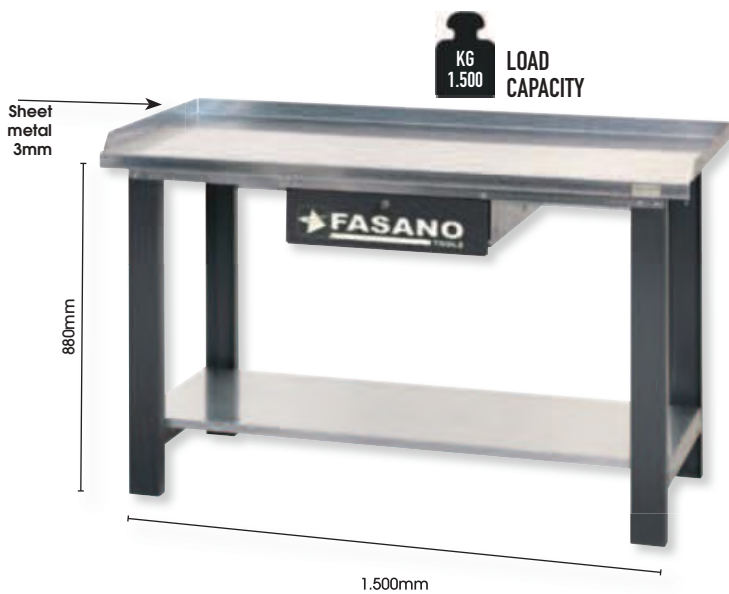

## Workbench 1.5mt with 1 drawers

### TECHNICAL FEATURES:

- Upper shelf in **3mm** steel sheet;
- Lower shelf in steel sheet supplied as standard
- 2 uprights;
- Prepared for floor fixing;
- Painted structure with epoxy paint.

Total weight: 83,5Kg  
Static load: 2000Kg  
Dimensions: **1.500x745x880mm**



CODE	€/Pz
FG 129/D1.5	<b>790,00</b>



CODE	€/Pz
FG 129/B1.5	<b>790,00</b>



CODE	€/Pz
FG 129/R1.5	<b>790,00</b>





**Professional workbench - 2.0m  
Equipped with 1 drawer cabinets  
- DARK GREY color**

*Total weight: 122.00 Kg*

CODE	DIMENSIONS	€/Pz
FG 131/D2	2.0000x745x920H	1.700,00

- Worktop in metal sheet 3mm
- 05 drawers installed on ball bearings sliding bars
- Central closing



**Professional workbench - 2.0m  
- RED color**

CODE	DIMENSIONS	€/Pz
FG 131/R2	2.0000x745x920H	1.700,00

**Professional workbench - 2.0m  
- BLUE color**

CODE	DIMENSIONS	€/Pz
FG 131/B2	2.0000x745x920H	1.700,00





**Professional workbench - 2.0m  
Equipped with 2 drawer cabinets  
- DARK GREY color**

*Total weight: 163.00 Kg*

CODE	DIMENSIONS	€/Pz
FG 132/D2	2.0000x745x920H	2.350,00

- Worktop in metal sheet 3mm
- 10 drawers installed on ball bearings sliding bars
- Central closing



**Professional workbench - 2.0m  
- RED color**

CODE	DIMENSIONS	€/Pz
FG 132/R2	2.0000x745x920H	2.350,00

**Professional workbench - 2.0m  
- BLUE color**

CODE	DIMENSIONS	€/Pz
FG 132/B2	2.0000x745x920H	2.350,00





**Professional workbench - 2.0m equipped with  
2 drawers and panel tool holder in  
GREY color**

*Total weight: 156.50 Kg*

CODE	€/Pz
FG 133/D2	2.300,00

- Worktop in metal sheet 3mm
- Lower sheet support in metal sheet 3mm
- 3 legs
- 2 drawers equipped with closing system
  - Arrangement for ground fixing
  - Structure painted with epoxy paint
- Panel tool holder with aluminum shutter with lock system

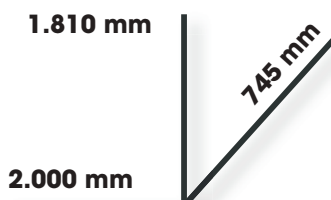

FG 133/R2



FG 133/B2



**Workbench - 2.0m  
equipped with drawer  
cabinet and panel tool  
holder**

CODE	€/Pz
FG 134/D2	3.000,00

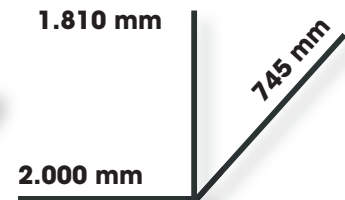

FG 134/R2



FG 134/B2



**Workbench - 2.0m  
equipped with drawer  
cabinets and panel  
tool holder**

CODE	€/Pz
FG 135/D2	3.600,00

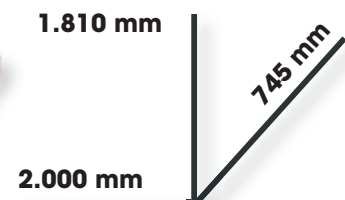

FG 135/R2



FG 135/B2





**Professional workbench - 2.0m  
equipped with drawer in DARK GREY color**

*Total weight: 106,50Kg*

CODE	DIMENSIONS	€/Pz
FG 129/LD2	2.000x640x900 mm	980,00

- Worktop in wood 25mm
- Lower sheet support in metal sheet 1.5mm
- 3 legs
- 2 drawers equipped with closing system
  - Arrangement for ground fixing
  - Structure painted with epoxy paint



**Professional workbench 2.0m  
equipped with drawer in RED color**

CODE	DIMENSIONS	€/Pz
FG 129/LR2	2.000x640x900 mm	980,00

**Professional workbench 2.0m  
equipped with drawer in BLUE color**

CODE	DIMENSIONS	€/Pz
FG 129/LB2	2.000x640x900 mm	980,00





**Professional workbench with beech worktop  
Equipped with 1 drawer cabinets**

CODE	€/Pz
FG 131/FD2	1.800,00

shelf thickness: 32mm

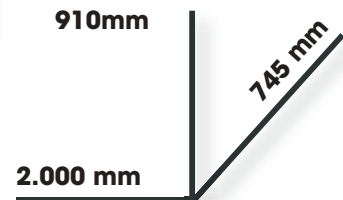

CODE	€/Pz
FG 131/FR2	1.800,00



CODE	€/Pz
FG 131/FB2	1.800,00



**Professional workbench with beech worktop  
Equipped with 2 drawer cabinets**

shelf thickness: 32mm

CODE	€/Pz
FG 132/FD2	2.350,00

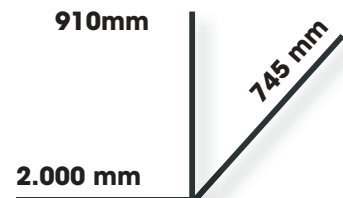

CODE	€/Pz
FG 132/FR2	2.350,00



CODE	€/Pz
FG 132/FB2	2.350,00







Dimension: 1.700x160x930mm

CODE	€/Pz
FG 128/GR2	1.500,00

### Panel tool holder with aluminum shutter

- Weight: 50Kg
- Aluminium shutter
- 2 plastic handles
- central closing system
- two holes on back for wall mounting



Dimension: 1.700x160x930mm

CODE	€/Pz
FG 128/RR2	1.500,00

### Panel tool holder with aluminum shutter

- Weight: 50Kg
- Aluminium shutter
- 2 plastic handles
- central closing system
- two holes on back for wall mounting



Dimension: 1.700x160x930mm

CODE	€/Pz
FG 128/BR2	1.500,00

### Panel tool holder with aluminum shutter

- Weight: 50Kg
- Aluminium shutter
- 2 plastic handles
- central closing system
- two holes on back for wall mounting



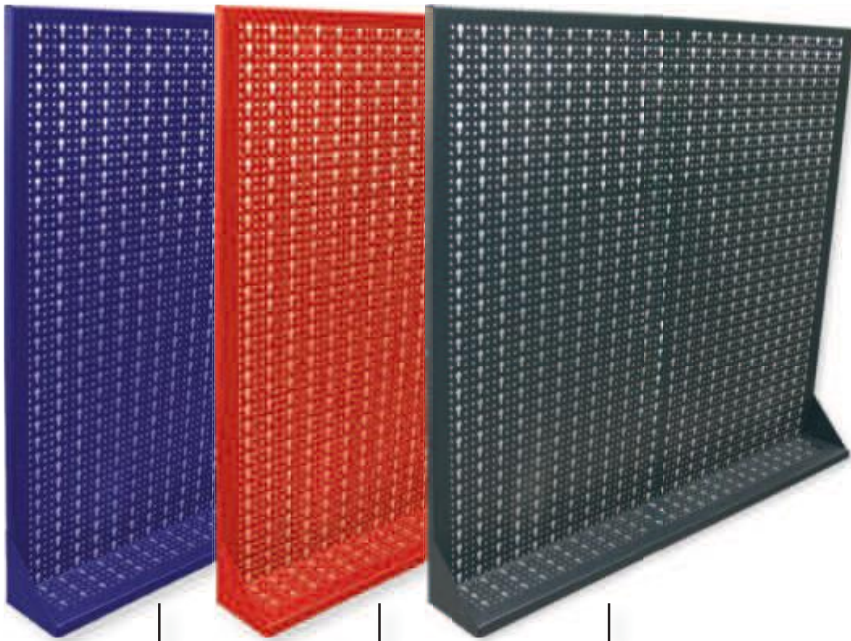

**FG 129/BR1** | **FG 129/RR1** | **FG 129/GR1**

**Tools panel equipped with shelf**

*Dimension: 945x120x860mm*

CODE	€/Pz
FG 129/GR1	<b>160,00</b>
FG 129/BR1	<b>160,00</b>
FG 129/RR1	<b>160,00</b>

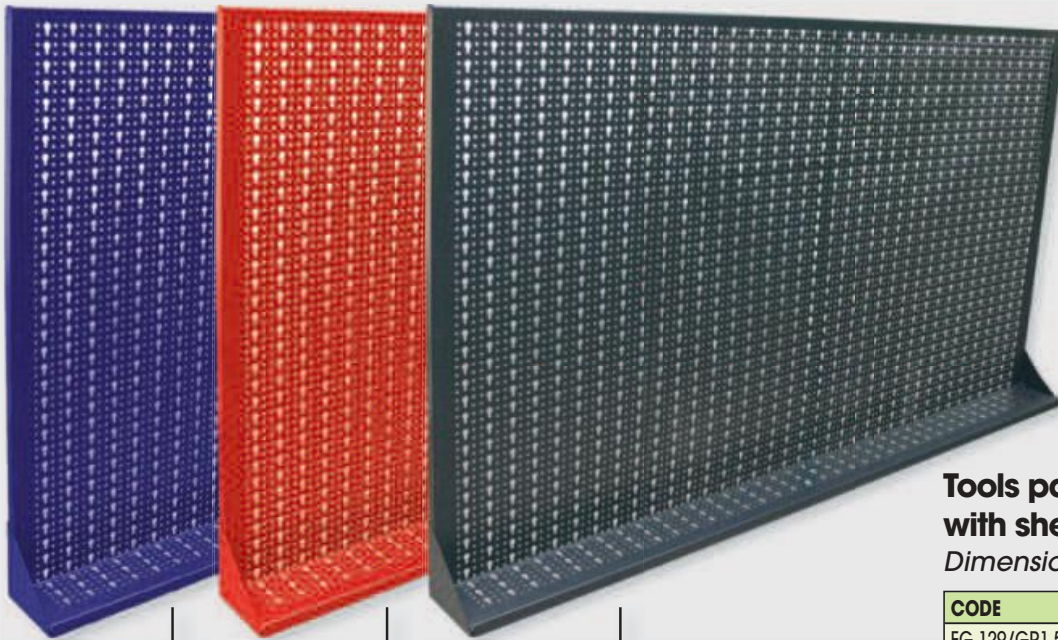

**FG 129/BR1.5** | **FG 129/RR1.5** | **FG 129/GR1.5**

**Tools panel equipped with shelf**

*Dimension: 1.440x120x860mm*

CODE	€/Pz
FG 129/GR1.5	<b>225,00</b>
FG 129/BR.15	<b>225,00</b>
FG 129/RR1.5	<b>225,00</b>



**Hooks**

CODE	DIMENSIONS	€/Pz
FG GA/80	L: 80mm	<b>1,00</b>
FG GA/120	L: 120mm	<b>1,20</b>
FG GA/T	Ø: 19mm	<b>1,30</b>





**Special tray shelf and slope features central holes to allow liquid to flow out quickly into the basin below**

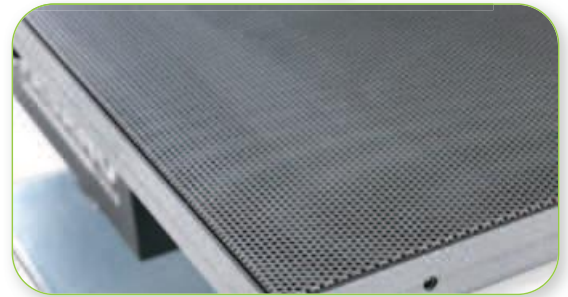

**Supplied with lower shelf support in metal sheet 3mm**

**Collection tank equipped with removable drain cock  
Capacity: 30 liters**



**Exhaust faucet**





**Professional workbench 1.5mt equipped with oil tank - GREY COLOR**  
Total weight: 85,00Kg

CODE	DIMENSIONS	€/Pz
FG 136/D1.5	1.500x745x920 mm	1.250,00



**Professional workbench 1.5mt equipped with oil tank - GREY COLOR and 4 swivel wheels**  
Total weight: 90,00Kg

CODE	DIMENSIONS	€/Pz
FG 137/D1.5	1.500x745x955 mm	1.400,00



**Professional workbench 1.5mt equipped with oil tank - RED COLOR**  
Total weight: 85,00Kg

CODE	DIMENSIONS	€/Pz
FG 136/R1.5	1.500x745x920 mm	1.250,00



**Professional workbench 1.5mt equipped with oil tank - RED COLOR and 4 swivel wheels**  
Total weight: 90,00Kg

CODE	DIMENSIONS	€/Pz
FG 137/R1.5	1.500x745x955 mm	1.400,00



**Professional workbench 1.5mt equipped with oil tank - BLU COLOR**  
Total weight: 85,00Kg

CODE	DIMENSIONS	€/Pz
FG 136/B1.5	1.500x745x920 mm	1.250,00



**Professional workbench 1.5mt equipped with oil tank - BLU COLOR and 4 swivel wheels**  
Total weight: 90,00Kg

CODE	DIMENSIONS	€/Pz
FG 137/B1.5	1.500x745x955 mm	1.400,00





*Particularly suggested to work on automatic transmissions*



*Collection tank equipped with removable of drain cock  
Capacity: 30 liters*



**Workbench 1.0mt with Stainless steel top**

CODE	DIMENSIONS	€/Pz
FG 130/A1	1.000x750x915 mm	1.220,00



**Workbench 1.0mt with sheet metal top**

CODE	DIMENSIONS	€/Pz
FG 130/D1	1.000x750x915 mm	850,00



**Workbench 1.0mt with Stainless steel top and 4 swivel wheels**

CODE	DIMENSIONS	€/Pz
FG 131/A1	1.000x750x915 mm	1.350,00



**Workbench 1.0mt with sheet metal top and 4 swivel wheels**

CODE	DIMENSIONS	€/Pz
FG 131/D1	1.000x750x915 mm	1.000,00

### Tool carrying trolley

- 2 fixed wheels, 1 swivel + 1 swivel w/brake (Ø100mm)
- Total weight: 16.4Kg



CODE	DIMENSIONS	€/Pz
FG 107/A	380x730x780mm	165,00



**KG**  
30  
**LOAD**  
**CAPACITY**  
single shelf

### Tool carrying trolley

- Metal sheet 1.5mm
- Professional wheels with zinc plate, swivel housing, plate fitting, with double ball race
- 2 fixed wheels, 1 swivel + 1 swivel w/brake (Ø80mm)
- Total weight: 19.5Kg

CODE	DIMENSIONS	€/Pz
FG 106/A	350x750x957mm	250,00



**KG**  
560  
**LOAD**  
**CAPACITY**  
distributed on  
3 shelves shelves

### Tool carrying trolley

- Metal sheet 1.5mm
- Professional wheels with zinc plate, swivel housing, plate fitting, with double ball race
- 2 fixed wheels, 1 swivel + 1 swivel w/brake (Ø100mm)
- Total weight: 22.0Kg

CODE	DIMENSIONS	€/Pz
FG 106/B	430x930x957mm	300,00

**KG**  
600  
**LOAD**  
**CAPACITY**



### Tool carrying trolley

- Metal sheet 1.5mm
- Professional wheels with zinc plate, swivel housing, plate fitting, with double ball race
- 2 fixed wheels, 1 swivel + 1 swivel w/brake (Ø125mm)
- Total weight: 44.0Kg

CODE	DIMENSIONS	€/Pz
FG 106/C	560x1.000x987mm	390,00

**KG**  
800  
**LOAD**  
**CAPACITY**



**FASANO**  
TOOLS



**FASANO**  
TOOLS



# 16

## INDUSTRIAL FURNITURE



 **FASANO**



MODULAR FORMS

FG 118



TAKEN IN EQUIPMENT  
220V SOCKET WITH 2 POLES + 1 SHUKO  
SOCKET WITH 2 POLES + USB



OIL DISTRIBUTION MODULE,  
EQUIPPED WITH 2 DIGITAL GUNS  
LITER COUNT



WALL UNITS EQUIPPED WITH GAS  
PISTONSTO FACILITATE THE OPENING DOOR  
CLOSING



RAL 6018

RAL 5002

RAL 3001



**AVAILABLE  
IN 3 COLORS**



WASTE COMPARTMENT MOUNTED ON TELESCOPIC GUIDES



WORKTOP IN STEEL AND STAINLESS STEEL AND EXTRACTION BATHTUB



DRAWERS PREPARED FOR INSERTING THE MODULES COMPLETE TOOLS



**MADE IN ITALY**



## Workshop equipment combination - 2.050mm

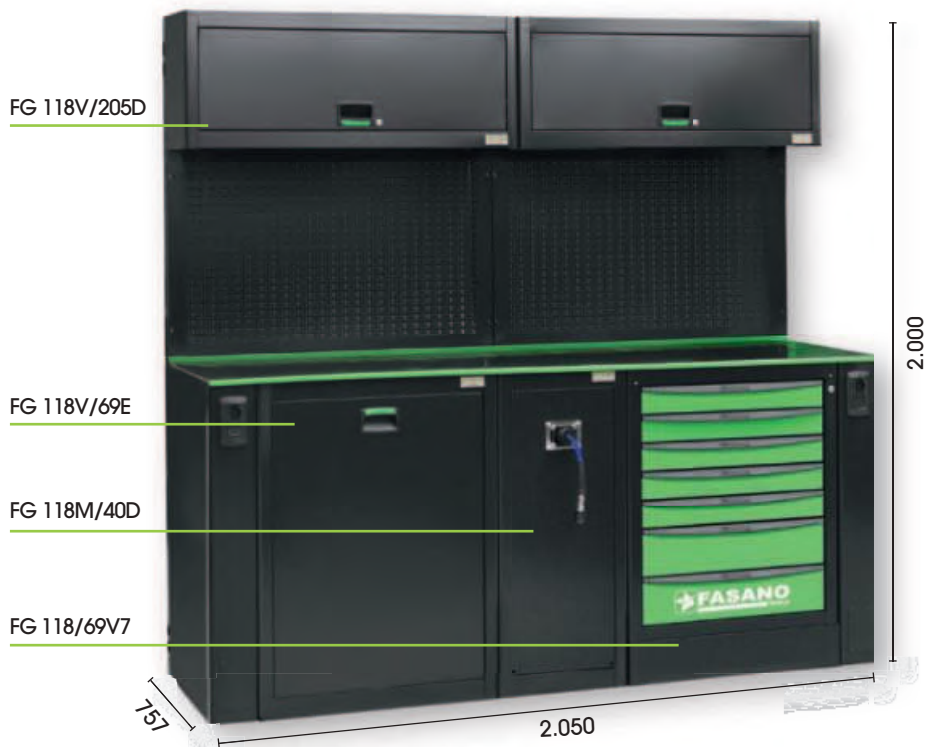

CODE	Dimensions	€/Pz
FG 118/CO1V	2.050x757x2.000mm	6.110,00



FG 118/CO1B



FG 118/CO1R

## Workshop equipment combination - 2.050mm

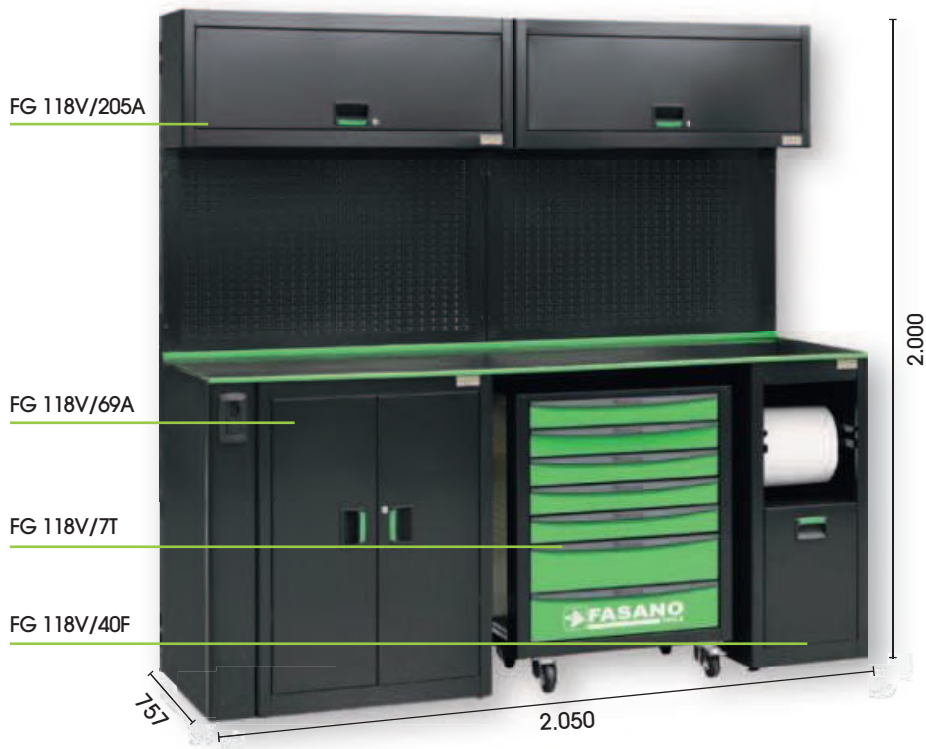

CODE	Dimensions	€/Pz
FG 118/CO2V	2.050x757x2.000mm	5.840,00



FG 118/CO2B



FG 118/CO2R

## Workshop equipment combination - 2.050mm



CODE	Dimensions	€/Pz
FG 118/CO3V	2.550x757x2.000mm	6.560,00



FG 118/CO3B



FG 118/CO3R

## Workshop equipment combination - 2.050mm

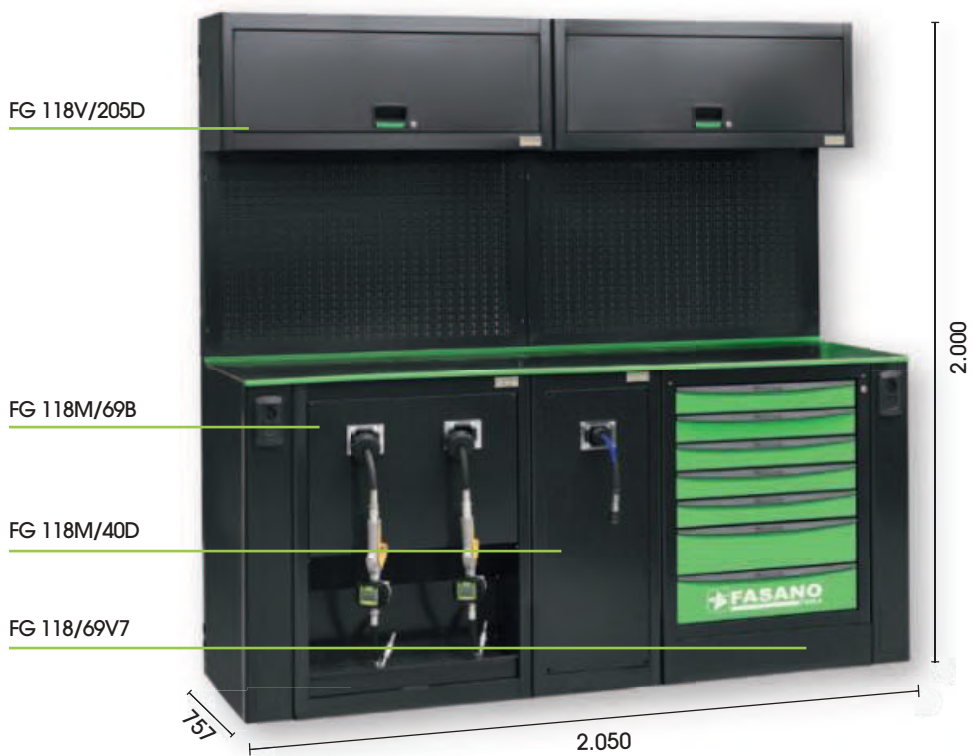

CODE	Dimensions	€/Pz
FG 118/CO4V	2.050x757x2.000mm	8.560,00



FG 118/CO4B



FG 118/CO4R



## Workshop equipment combination - 2.050mm

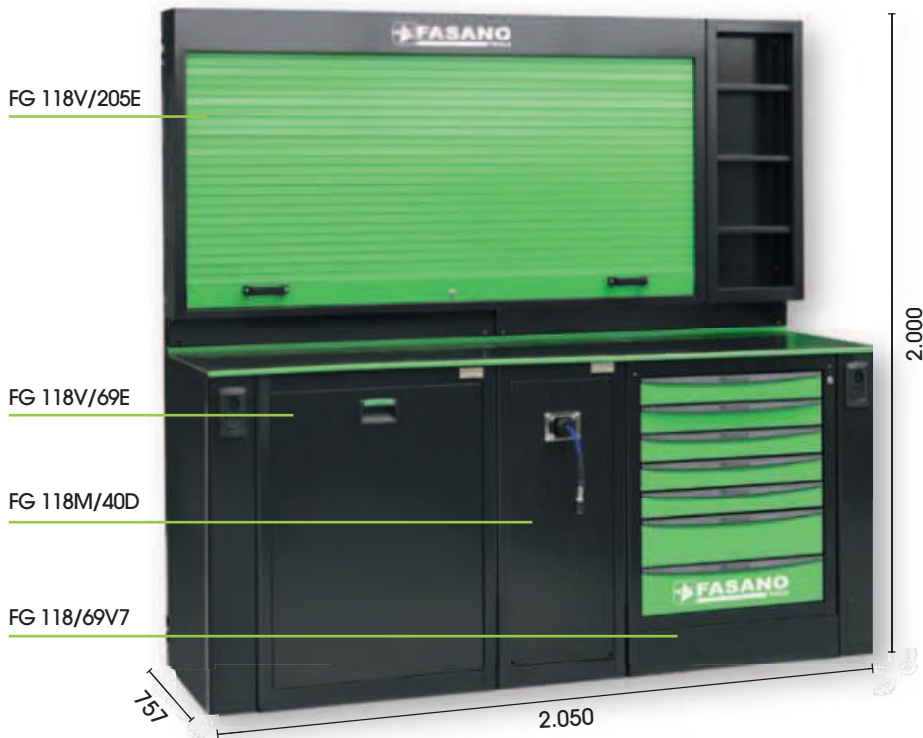

CODE	Dimensions	€/Pz
FG 118/CO5V	2.050x757x2.000mm	7.080,00



FG 118/CO5B



FG 118/CO5R

## Workshop equipment combination - 3.050mm



CODE	Dimensions	€/Pz
FG 118/CO6V	3.050x757x2.000mm	8.520,00



FG 118/CO6B



FG 118/CO6R

**Workshop equipment combination  
- 1.225mm**



CODE	Dimensions	€/Pz
FG 118/CO7V	1.225x757x2.000mm	4.400,00



FG 118/CO7B

FG 118/CO7R

**Workshop equipment combination  
- 1.225mm**

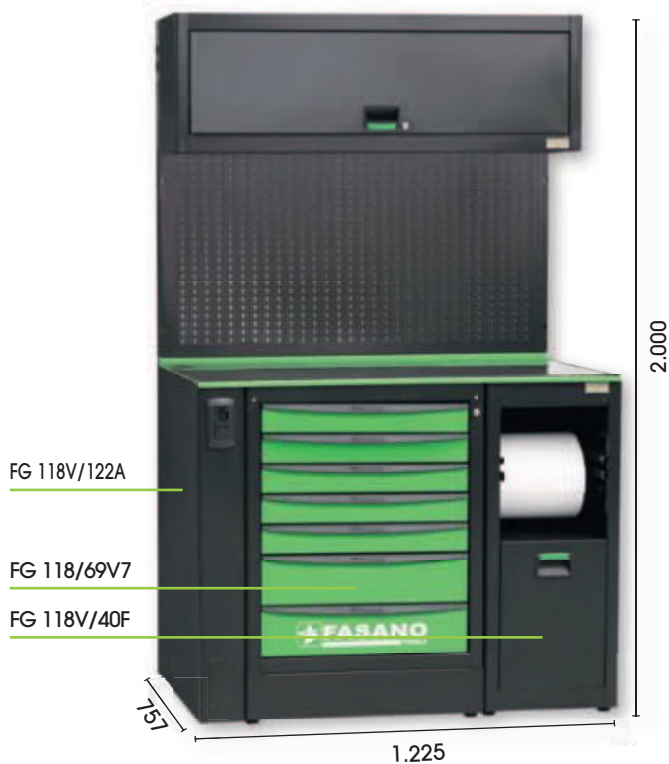

CODE	Dimensions	€/Pz
FG 118/CO8V	1.225x757x2.000mm	3.770,00



FG 118/CO8B

FG 118/CO8R



# 16 INDUSTRIAL FURNITURE

## Workshop equipment combination - 2.050mm



CODE	Dimensions	€/Pz
FG 118/CO9V	2.050x707x990mm	5.530,00



FG 118/CO9B



FG 118/CO9R

## Workshop equipment combination - 2.050mm



CODE	Dimensions	€/Pz
FG 118/CO10V	2.050x707x990mm	5.240,00



FG 118/CO10B



FG 118/CO10R

**Workshop equipment combination  
- 1.225mm**



CODE	Dimensions	€/Pz
FG 118/CO15V	1.225x707x990mm	3.850,00

**Workshop equipment combination  
- 1.225mm**



CODE	Dimensions	€/Pz
FG 118/CO16V	1.225x707x990mm	3.440,00





## Workshop equipment combination - 5.600mm

CODE	Dimensions	€/Pz
FG 118/CO20V	5.600x757x2.000mm	14.420,00



FG 118/CO20B



FG 118/CO20R



## Workshop equipment combination - 5.600mm

CODE	Dimensions	€/Pz
FG 118/CO21V	5.600x757x2.000mm	17.840,00



FG 118/CO21B



FG 118/CO21R





Empty workshop equipment combination, supplied with suspended cabinets

CODE	Dimensions	€/Pz
FG 118V/205L	2.050x757x2.000mm	3.680,00



Empty workshop equipment combination with panel tool holder

CODE	Dimensions	€/Pz
FG 118V/205M	2.050x757x2.000mm	4.650,00

**Empty workshop equipment combination with simple tool racks**



CODE	Dimensions	€/Pz
FG 118V/205P	2.050x757x2.000mm	3.250,00



FG 118B/205P



FG 118R/205P



**Empty workshop equipment combination with simple tool racks**

CODE	Dimensions	€/Pz
FG 118V/205Q	2.050x707x990mm	3.150,00



FG 118B/205Q



FG 118R/205Q



**LED lighting system**

- Length: 900mm
- Fixing system by pair of magnets
- 600 Lumen

CODE	€/Pz
FG 118/LED	96,00



**30 watt transformer**

In case of more than 1 LED strip it is sufficient to consider 1 transformer every 2 strips

CODE	€/Pz
FG 118/TR	80,00



**Straight hook 80mm**

CODE	€/Pz
FG GA/80	1,00

**Straight hook 120mm**

CODE	€/Pz
FG GA/120	1,20

**Eye hook**

CODE	€/Pz
FG GA/T	1,30

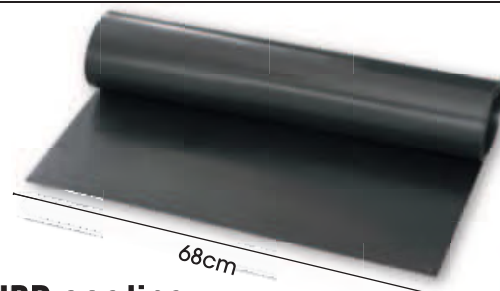

**NBR coating**

Resistant to oils and hydrocarbons

CODE	LUNGHEZZA	€/Pz
FG118/NBR1	1.220mm	98,00
FG118/NBR2	2.050mm	120,00
FG118/NBR3	for angle module	120,00



# 16 INDUSTRIAL FURNITURE

MODULAR SOLUTION FOR COMPOSING  
THE TECHNICAL FURNITURE

within 3 easy STEP

## 1 STEP

## TOP

SELECT BASIC STRUCTURE  
FOR TOP:



WITH SUSPENDED CABINETS



WITH TOOL HOLDER WALL



WITH TOOL HOLDER

WITHOUT TOP  
GO TO STEP 2



## 2 STEP

## BOTTOM

SELECT BASIC STRUCTURE  
FOR BOTTOM:



WITH PREDISPOSITION FOR WHEELED TROLLEY



WITHOUT PREDISPOSITION FOR WHEELED TROLLEY

## 3 STEP

## FORMS

SELECT FORM  
FOR BOTTOM:



TROLLEY



LENGTH 69



LENGTH 40

## BASIC STRUCTURE FOR CONFIGURATIONS WITH TROLLEY



Empty workshop equipment combination, supplied with suspended cabinets

CODE	Dimensions	€/Pz
FG 118V/205A	2.050x757x2.000mm	2.750,00

### Configuration with tool holder wall



CODE	Dimensions	€/Pz
FG 118V/205B	2.050x757x2.000mm	3.700,00

### Configuration with tool holder

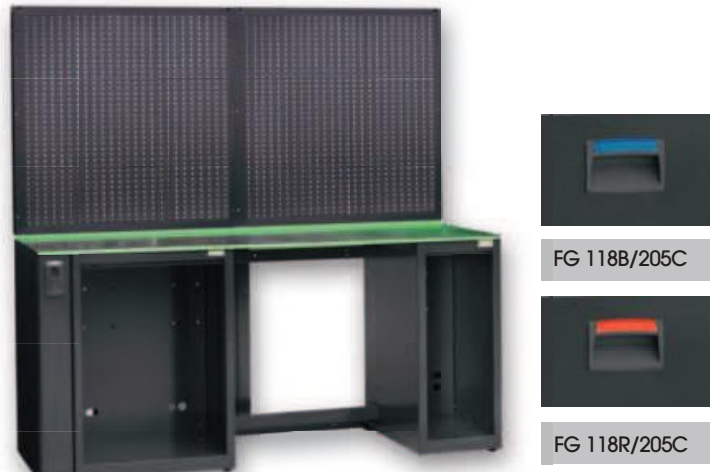

CODE	Dimensions	€/Pz
FG 118V/205C	2.050x757x2.000mm	2.200,00



## BASIC STRUCTURE FOR CONFIGURATIONS WITHOUT TROLLEY



Empty workshop equipment combination, supplied with suspended cabinets

CODE	Dimensions	€/Pz
FG 118V/205D	2.050x757x2.000mm	2.980,00

### Configuration with tool holder wall



CODE	Dimensions	€/Pz
FG 118V/205E	2.050x757x2.000mm	3.950,00

### Configuration with tool holder



CODE	Dimensions	€/Pz
FG 118V/205F	2.050x757x2.000mm	2.400,00

**Empty workshop equipment combination, supplied with suspended cabinet**

CODE	Dimensions	€/Pz
FG 118V/122A	1.225x757x2.000mm	1.750,00



FG 118B/122A



FG 118R/122A

MODULE 69

MODULE 40



**Empty workshop equipment combination**



CODE	Dimensions	€/Pz
FG 118V/122B	1.225x757x2.000mm	1.360,00



FG 118B/122B



FG 118B/122R

**Special workshop equipment combination with Stainless steel worktop**



MODULE 40

MODULE 69  
FLUID DISCHARGE  
CABINET

CODE	Dimensions	€/Pz
FG 118V/122C	1.225x757x2.000mm	3.500,00



FG 118B/122B



FG 118B/122R



STAINLESS STEEL WORKTOP  
AND REMOVABLE  
COLLECTION BATHTUB





# 16 INDUSTRIAL FURNITURE

## Empty workshop equipment combination, supplied with simple tool rack

CODE	Dimensions	€/Pz
FG 118V/80AN	776x776x2.000mm	1.380,00



FG 118B/80AN



FG 118R/80AN

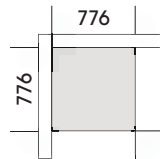

## Empty workshop equipment combination, supplied with simple tool rack

CODE	Dimensions	€/Pz
FG 118V/138AN	1.028x1028x2.000mm	1.480,00



FG 118B/138AN



FG 118R/138AN

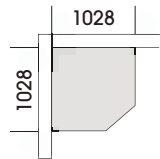

MODULE 40

## Workshop equipment combination

CODE	Dimensions	€/Pz
FG 118V/80ANT	726x726x970mm	920,00



FG 118B/80ANT



FG 118R/80ANT

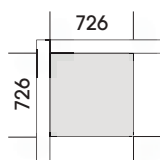

## Empty workshop equipment combination

CODE	Dimensions	€/Pz
FG 118V/138ANT	978x978x990mm	1.020,00



MODULE 40



FG 118B/138ANT



FG 118R/138ANT

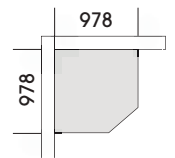

## Empty workshop equipment combination

CODE	Dimensions	€/Pz
FG 118V/205G	2.050x707x990mm	2.150,00



FG 118B/205G



FG 118R/205G

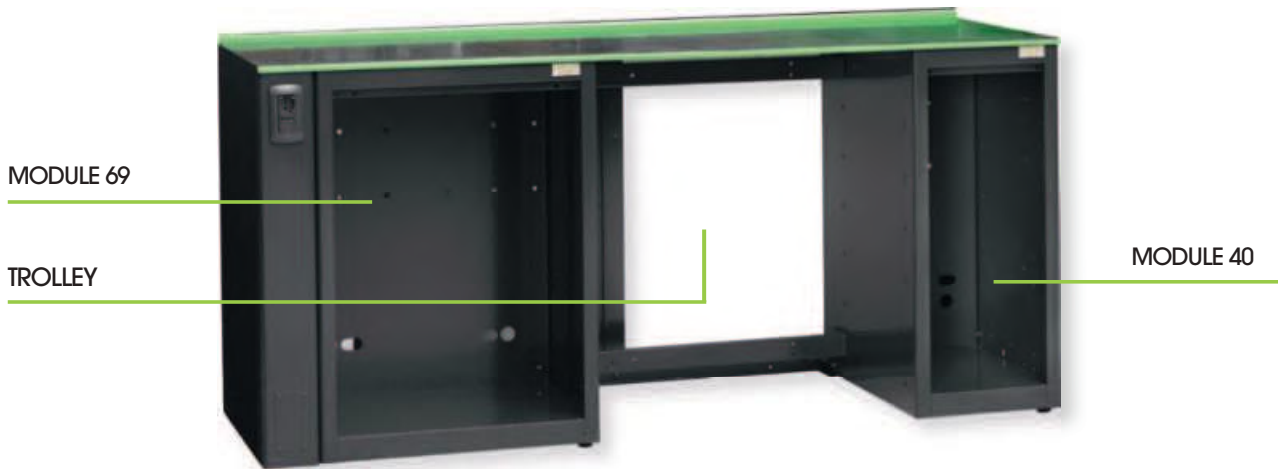

## Empty workshop equipment combination

CODE	Dimensions	€/Pz
FG 118V/205H	2.050x707x990mm	2.400,00



FG 118B/205H



FG 118R/205H



## Empty workshop equipment combination



FG 118B/122H



FG 118R/122H

CODE	Dimensions	€/Pz
FG 118V/122H	1.225x707x990mm	1.420,00



## FORMS

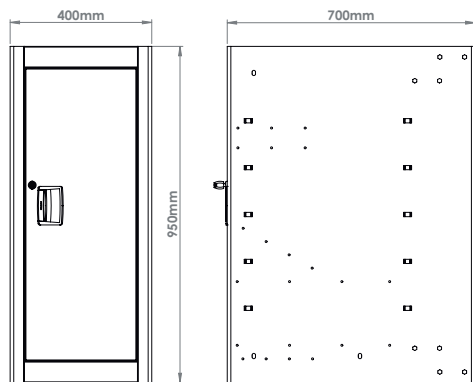

CODE	WEIGHT	€/Pz
FG 118V/40A	30,00 Kg	740,00

### Fixed module with 1 door

- 120° opening door
- Internal removable shelves



FG 118B/40A



FG 118R/40A



### Service module for oil distribution

- Automatic reel with 7,5m - 1/2" hose
- Digital gun with liter counter and automatic drip catcher (Max flow rate: 40L/min)
- Stainless steel support grid

CODE	WEIGHT	€/Pz
FG 118M/40B	42,00 Kg	1.960,00

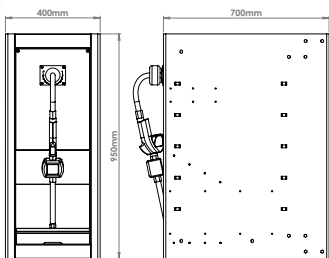

### Service module for anti-freeze liquid distribution

- Automatic reel with 7,5m - 1/2" hose
- Digital gun with liter counter and automatic drip catcher (Max flow rate: 40L/min)
- Stainless steel support grid

CODE	WEIGHT	€/Pz
FG 118M/40C	42,00 Kg	2.100,00

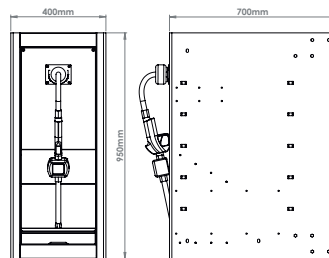

### Oil recovery module

- Automatic reel with 7,5m - 1/2" hose
- Probe port connection for hose
- Probe kit 10pcs
- Probe holder bracket
- Stainless steel support grid

CODE	WEIGHT	€/Pz
FG 118M/40G	42,00 Kg	1.960,00

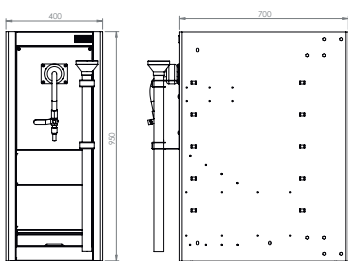

**NEW**

### Service module for compressed air + electricity

- Retractor with hose 1/4", 15 meters
- Automatic reel 15m 3Gx1.5mm<sup>2</sup> with SHUCKO socket

CODE	WEIGHT	€/Pz
FG 118M/40H	41,00 Kg	1.150,00

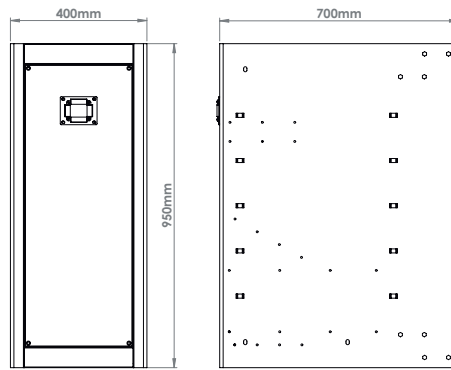

CODE	WEIGHT	€/Pz
FG 118M/40D	32,50 Kg	<b>900,00</b>

### Service module for air distribution

- Hose reel with PVC hose, 1/4" - 15meters
- Automatic guide system
- Stop at any point
- Slow retraction system

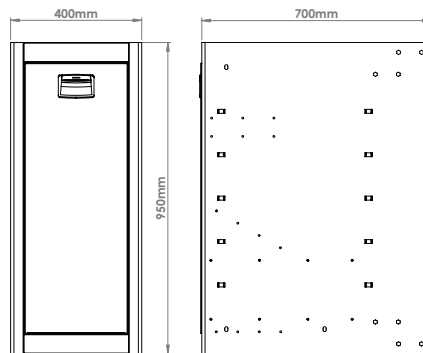

CODE	WEIGHT	€/Pz
FG 118V/40E	35,50 Kg	<b>740,00</b>

### Waste collection module

- Equipped with telescopic ball bearing slidings
- Capacity: 35Kg



FG 118B/40E



FG 118R/40E



CODE	WEIGHT	€/Pz
FG 118V/40F	33,00 Kg	<b>740,00</b>

### Service module for paper and waste

- Equipped with telescopic ball bearing slidings
- Capacity: 35Kg



FG 118B/40F



FG 118R/40F





## Fixed module with 2 doors

- 120° opening doors
- Internal removable shelves
- Central closing system

CODE	WEIGHT	€/Pz
FG 118V/69A	34,00 Kg	950,00



FG 118B/69A

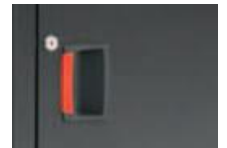

FG 118R/69A

## Service module for oil distribution

- Automatic reels with 7,5m - 1/2" hose
- 2 Digital guns with liter counter and automatic drip catcher (Max flow rate: 40L/min)
- Stainless steel support grid



CODE	WEIGHT	€/Pz
FG 118M/69B	60,00 Kg	3.400,00

## Service module for oil distribution and recovery

- Automatic reels with 7,5m - 1/2" hose
- 1 Digital gun with liter counter and automatic drip catcher (Max flow rate: 40L/min)
- Probe port connection for hose
- Probe kit 10pcs
- Probe holder bracket
- Stainless steel support grid



CODE	WEIGHT	€/Pz
FG 118M/69G	60,00 Kg	3.400,00

## Waste collection module

- Equipped with telescopic ball bearing slidings
- Capacity: 35Kg



CODE	WEIGHT	€/Pz
FG 118V/69E	40,00 Kg	950,00

**NEW**

## Service module for compressed air + electricity

- Retractor with hose 1/4", 15 meters
- Automatic reel 15m 3Gx1.5mm<sup>2</sup> with SHUCKO socket



CODE	WEIGHT	€/Pz
FG 118M/69H	41,00 Kg	1.350,00

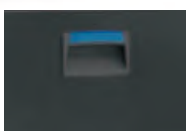

FG 118B/69E



FG 118R/69E



## FIXED TOOL BOXES

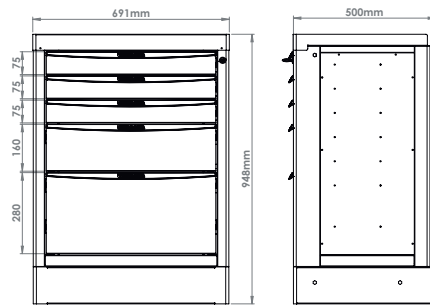

CODE	WEIGHT	€/Pz
FG 118/69V5	48,50 Kg	1.160,00

### Fixed tool box with 5 drawers

- Ball bearing slidings with telescopic system
- Central closing system
- Drawers equipped with internal rubber mat
- Drawers' dimension valid for tool forms



FG 118/69B5



FG 118/69R5

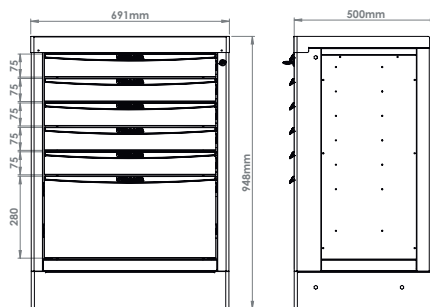

CODE	WEIGHT	€/Pz
FG 118/69V6	50,00 Kg	1.220,00

### Fixed tool box with 6 drawers

- Ball bearing slidings with telescopic system
- Central closing system
- Drawers equipped with internal rubber mat
- Drawers' dimension valid for tool forms



FG 118/69B6



FG 118/69R6

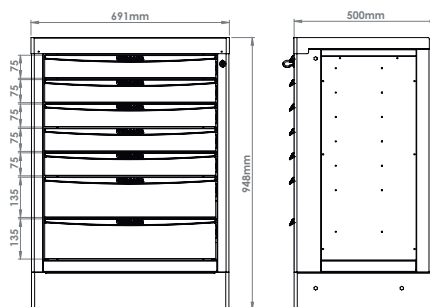

CODE	WEIGHT	€/Pz
FG 118/69V7	50,00 Kg	1.280,00

### Fixed tool box with 7 drawers

- Ball bearing slidings with telescopic system
- Central closing system
- Drawers equipped with internal rubber mat
- Drawers' dimension valid for tool forms

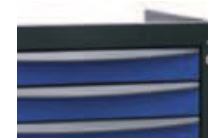

FG 118/69B7



FG 118/69R7



## TROLLEYS

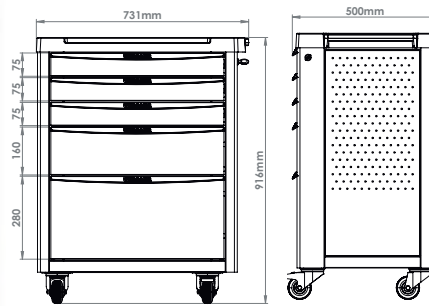

CODE	WEIGHT	€/Pz
FG 118V/5T	50,00 Kg	1.280,00

### Mobile tool box with 5 drawers

- Ball bearing slidings with telescopic system
- Central closing system
- Drawers equipped with internal rubber mat
- Drawers' dimension valid for tool forms



FG 118B/5T

FG 118R/5T

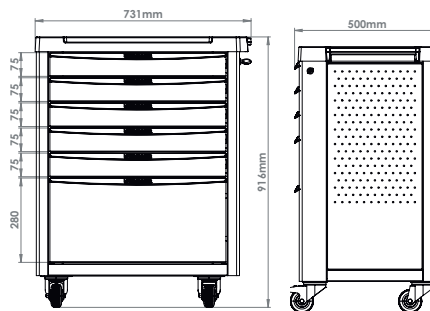

CODE	WEIGHT	€/Pz
FG 118V/6T	51,00 Kg	1.340,00

### Mobile tool box with 6 drawers

- Ball bearing slidings with telescopic system
- Central closing system
- Drawers equipped with internal rubber mat
- Drawers' dimension valid for tool forms



FG 118B/6T

FG 118R/6T

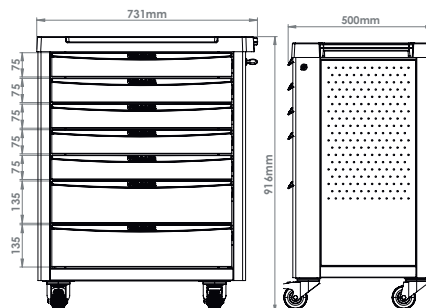

CODE	WEIGHT	€/Pz
FG 118V/7T	52,00 Kg	1.400,00

### Mobile tool box with 7 drawers

- Ball bearing slidings with telescopic system
- Central closing system
- Drawers equipped with internal rubber mat
- Drawers' dimension valid for tool forms



FG 118B/7T

FG 118R/7T

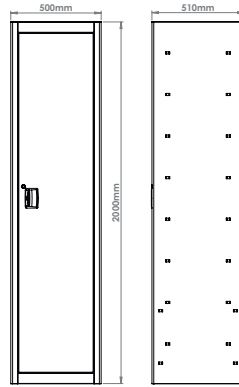

### Metal cabinet with 1 door

- 120° opening door
- 4 internal removable and adjustable shelves
- Equipped with closing system

CODE	WEIGHT	€/Pz
FG 118/AR1V	53,00 Kg	<b>720,00</b>



FG 118/AR1B



FG 118/AR1R



### Metal cabinet with 2 doors

- 120° opening doors
- 4 internal removable and adjustable shelves
- Equipped with closing system

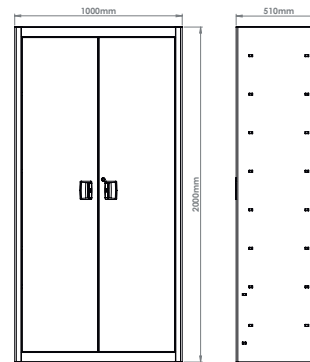

CODE	WEIGHT	€/Pz
FG 118/AR2V	86,00 Kg	<b>1.100,00</b>



FG 118/AR2B



FG 118/AR2R



### Metal cabinet with 2 doors, equipped with 3 drawers

- 120° opening doors
- 4 internal removable and adjustable shelves
- Equipped with closing system

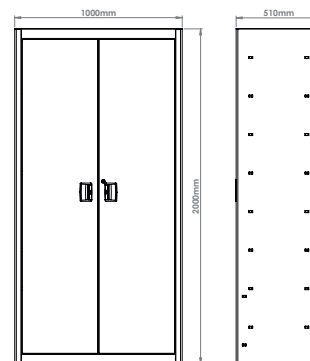

CODE	WEIGHT	€/Pz
FG 118/AR3V	105,50 Kg	<b>1.750,00</b>



FG 118/AR3B



FG 118/AR3R





MODULAR FORMS

FG 116

NEW



RAL 7021

RAL 6018

13 SINGLE MODULES for organization and customization of your working space

TROLLEYS

FIXED TOOL BOXES



MULTIFUNCTION MODULES





DRAWERS DESIGNED TO BE COMPATIBLE WITH FASANO TOOLS MODULES



GALVANIZED STEEL WORKTOP, THICKNESS 2MM

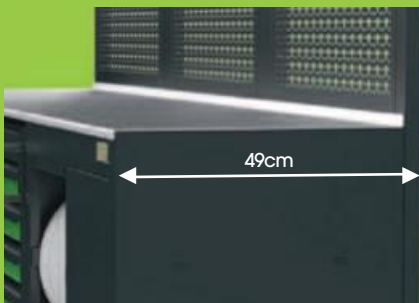

COMPACT DESIGN, 49 CM DEPTH



WASTE COLLECTION DRAWER FIXED ON TELESCOPIC GUIDES



PERFORATED TOOL PANELS

## NEW WORKSHOP EQUIPMENT

for organization and customization of your working space

### COMPACT:

49 cm depth, perfect also in smaller spaces

### STURDY:

Galvanized steel worktop, thickness 2mm  
Galvanized and painted metal structure, thickness 1mm

### QUALITY:

Structure for wall cabinets and perforated tools panels realized with columns fixed on modules for a high durability

### COMPATIBILITY:

Drawers designed to be compatible with Fasano Tools modules

### MADE IN ITALY:

Designed and produced in Italy, to focus on choice of materials, attention to details and smart style

### VERSATILE:

Flexible and modular system, with possibilities of complete customization or choice of predetermined combinations that can be expanded or modified in time

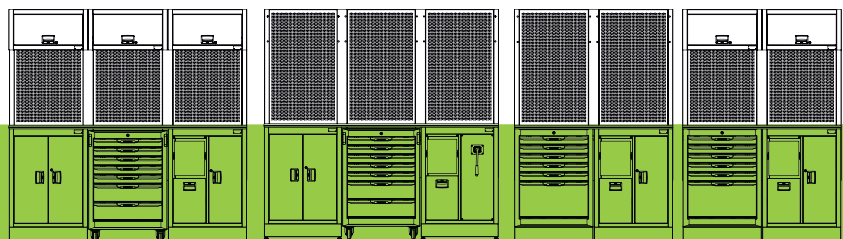

## 4 BASE STRUCTURE

MADE IN ITALY

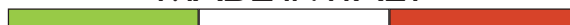

NEW

WORKSHOP COMBINATION FG 116 - 2.065 mm



- FG 116V/68A: Fixed module
- FG 116V/7G: Mobile tool box
- FG 116V/68B: Service module for paper and waste

CODE	DIMENSION	€/Pz
FG 116/CO2V	2065x490x2000	4.305,00



- FG 116V/68B: Service module for paper and waste
- FG 116V/7G: Mobile tool box
- FG 116M/68E: Servicen module for compressed air + electricity

CODE	DIMENSION	€/Pz
FG 116/CO1V	2065x490x2000	4.770,00



- FG 116V/68A: Fixed module
- FG 116/68V7: Fixed tool box with 7 drawers
- FG 116V/68B: Service module for paper and waste

CODE	DIMENSION	€/Pz
FG 116/CO6V	2065x490x2000	4.355,00



- FG 116V/68A: Fixed module
- FG 116/68V6: Fixed tool box with 6 drawers
- FG 116V/68B: Service module for paper and waste

CODE	DIMENSION	€/Pz
FG 116/CO10V	2065x490x2000	3.535,00

**NEW** WORKSHOP COMBINATION FG 116 - 2.065 mm + CABINET



- FG 116V/68A: Fixed module
- FG 116V/7G: Mobile tool box
- FG 116V/68B: Service module for paper and waste
- FG 118/AR1V: Metal cabinet - 500x510x2.000mm

CODE	DIMENSION	€/Pz
FG 116/CO3V	2565x510x2000	<b>5.025,00</b>



- FG 116V/68A: Fixed module
- FG 116/68V7: Mobile tool box
- FG 116V/68B: Service module for paper and waste
- FG 118/AR1V: Metal cabinet - 500x510x2.000mm
- FG 118/AR2V: Metal cabinet - 1.000x510x2.000mm

CODE	DIMENSION	€/Pz
FG 116/CO4V	3.565x510x2000	<b>6.125,00</b>



## NEW WORKSHOP COMBINATION FG 116 - 1.375 mm



- FG 116/68V6: Fixed tool box with 6 drawers
- FG 116V/68B: Service module for paper and waste

CODE	DIMENSION	€/Pz
FG 116/CO15V	1375x490x2000	3.060,00



- FG 116/68V6: Fixed tool box with 6 drawers
- FG 116V/68B: Service module for paper and waste

CODE	DIMENSION	€/Pz
FG 116/CO14V	1375x490x2000	2.540,00

## NEW WORKSHOP COMBINATION FG 116 - 1.375 mm + CABINET



- FG 116V/68A: Fixed module
- FG 116/68V5: Fixed tool box with 5 drawers
- FG 118/AR1V: Metal cabinet - 500x510x2.000mm

CODE	DIMENSION	€/Pz
FG 116/CO16V	1875x510x2000	3.505,00



- FG 116V/68A: Fixed module
- FG 116/68V5: Fixed tool box with 5 drawers
- FG 118/AR1V: Metal cabinet - 500x510x2.000mm

CODE	DIMENSION	€/Pz
FG 116/CO17V	1875x510x2000	2.985,00

**NEW**

**WORKSHOP COMBINATION FG 116**



- FG 116V/68B: Service module for paper and waste
- FG 116V/7G: Mobile tool box
- FG 116V/68A: Metal cabinet
- FG 116/68V6: Fixed tool box with 6 drawers
- FG 116V/68A: Metal cabinet

CODE	DIMENSION	€/Pz
FG 116/CO30V	2.566x490x2.000 1.885x490x2.000	<b>8.070,00</b>



- FG 116V/68B: Service module for paper and waste
- FG 116V/7G: Mobile tool box
- FG 116V/68A: Fixed module
- FG 116/68V6: Fixed tool box with 6 drawers
- FG 116V/68A: Fixed module

- FG 118/AR1V: Metal cabinet - 500x510x2.000mm
- FG 118/AR2V: Metal cabinet - 1.000x510x2.000mm

CODE	DIMENSION	€/Pz
FG 116/CO32V	3.066x510x2.000 2.885x510x2.000	<b>9.890,00</b>



# 16 INDUSTRIAL FURNITURE

MODULAR SOLUTION FOR COMPOSING  
THE TECHNICAL FURNITURE

within 2 easy STEP

1 STEP

TOP

SELECT BASIC STRUCTURE  
FOR TOP:



WITH SUSPENDED CABINETS



WITH TOOL HOLDER

2 STEP

FORMS

SELECT MODULES  
FOR THE BOTTOM:



TROLLEY



LENGTH 68

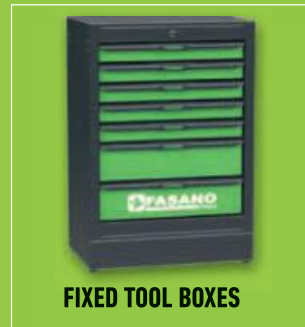

FIXED TOOL BOXES

FASANO  
TOOLS



**NEW BASIC STRUCTURE 2.065MM**



**Basic structure 2.065 mm, supplied with 3 suspended cabinet and tool holder**

CODE	DIMENSION	€/Pz
FG 116V/207A	2.065x490x2.000mm	<b>1.830,00</b>

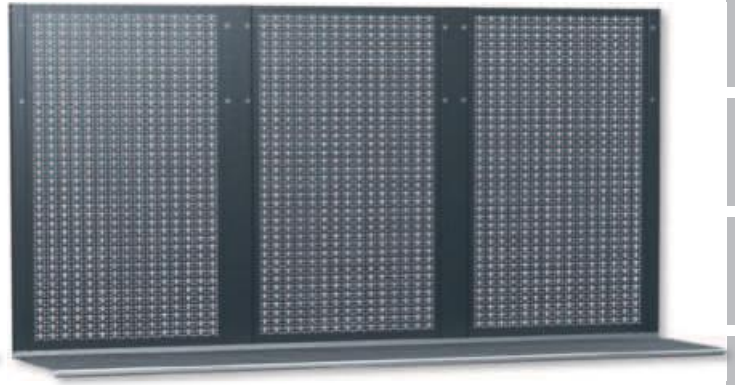

**Basic structure 2.065 mm, with tool holder**

CODE	DIMENSION	€/Pz
FG 116/207B	2.065x490x2.000mm	<b>1.040,00</b>

**NEW BASIC STRUCTURE 1.375MM**



**Basic structure 1.375 mm, supplied with 2 suspended cabinet and tool holder**

CODE	DIMENSION	€/Pz
FG 116V/138A	1.375x490x2.000mm	<b>1.280,00</b>

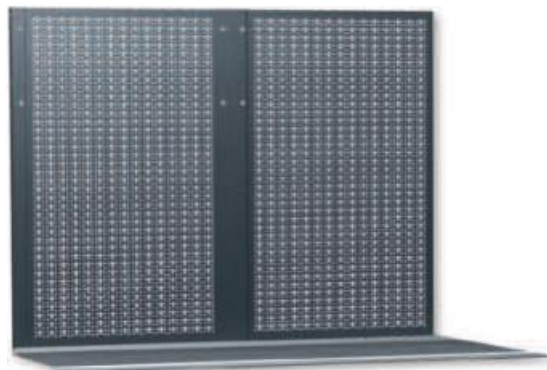

**Basic structure 1.375 mm, with tool holder**

CODE	DIMENSION	€/Pz
FG 116/138B	1.375x490x2.000mm	<b>760,00</b>



**Corner module equipped with 2 grills tool holder**

CODE	€/Pz
FG 116/50AN	<b>950,00</b>

510x510x2.000mm

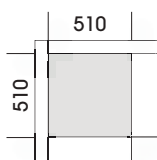

**Metal cabinet with 1 door**

CODE	€/Pz
FG 118/AR1V	<b>720,00</b>

**Metal cabinet with 2 doors**

CODE	€/Pz
FG 118/AR2V	<b>1.100,00</b>







**NEW**

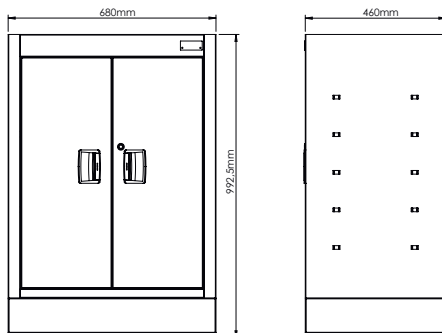

### Fixed module with 2 doors

- 120° opening doors
- Internal removable shelves
- Central closing system

CODE	WEIGHT	€/Pz
FG 116V/68A	34,00 Kg	<b>715,00</b>



**NEW**

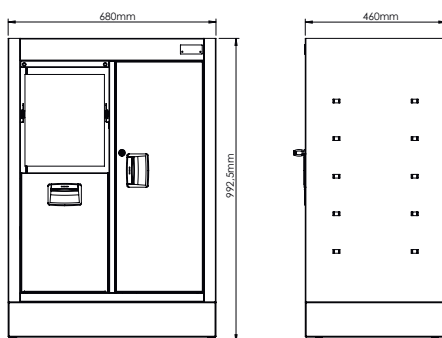

### Service module for paper and waste

- 120° opening doors
- Internal removable shelves
- Central closing system
- Equipped with telescopic ball bearing slidings
- Capacity: 35Kg

CODE	WEIGHT	€/Pz
FG 116V/68B	38,00 Kg	<b>960,00</b>



**NEW**

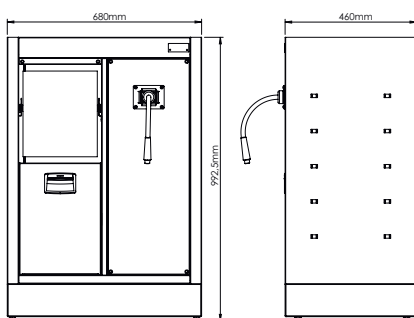

### Service module for compressed air and service module for paper and waste

- Automatic reel 15m 3Gx1.5mm<sup>2</sup> with SHUCKO socket
- Equipped with telescopic ball bearing slidings

CODE	WEIGHT	€/Pz
FG 116V/68C	42,00 Kg	<b>1.050,00</b>



**NEW**

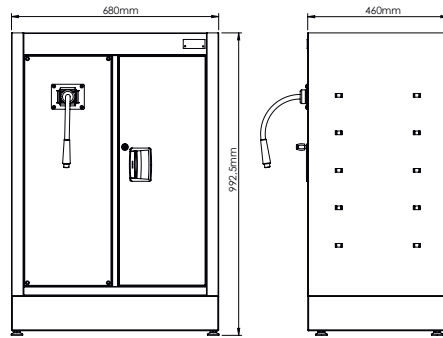

**Service module for compressed air and service module for paper and waste**

- Automatic reel 15m 3Gx1.5mm<sup>2</sup> with SHUCKO socket
- Door that can be opened to 120°
- Removable internal shelf
- Closing lock

CODE	WEIGHT	€/Pz
FG 116V/68D	41,00 Kg	<b>930,00</b>



**NEW**

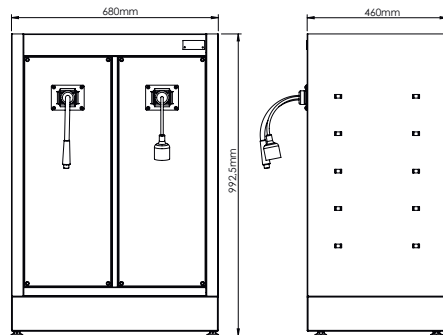

**Service module for compressed air + electricity**

- Retractor with hose 1/4", 15 meters
- Automatic reel 15m 3Gx1.5mm<sup>2</sup> with SHUCKO socket

CODE	WEIGHT	€/Pz
FG 116M/68E	47,00 Kg	<b>1.180,00</b>



**NEW**

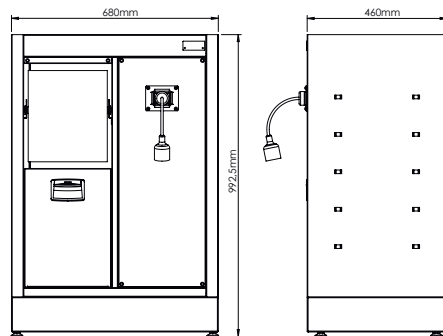

**Service module for electricity and service module for paper and waste**

- Automatic reel 15m 3Gx1.5mm<sup>2</sup> with SHUCKO socket
- Equipped with telescopic ball bearing slidings
- Capacity: 35Kg

CODE	WEIGHT	€/Pz
FG 116V/68F	42,00 Kg	<b>1.160,00</b>



**NEW**

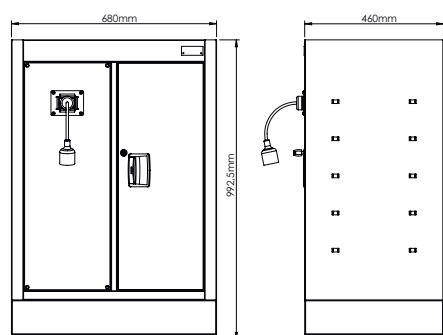

**Service module for electricity + fixed module 1 door**

- Automatic reel 15m 3Gx1.5mm<sup>2</sup> with SHUCKO socket
- 120° opening doors
- Internal removable shelves
- Central closing system

CODE	WEIGHT	€/Pz
FG 116V/68G	41,00 Kg	<b>1.040,00</b>



## FIXED TOOL BOXES

NEW

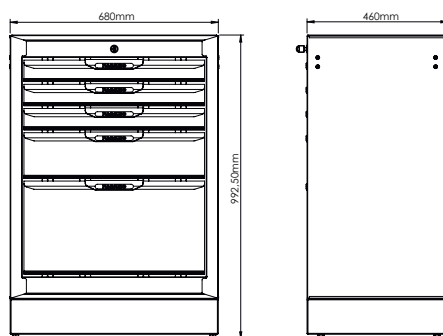

### Fixed tool box with 5 drawers

- Ball bearing slidings with telescopic system
- Central closing system
- Drawers equipped with internal rubber mat
- Drawers' dimension valid for tool forms

CODE	WEIGHT	€/Pz
FG 116/68V5	59,00 Kg	790,00

NEW



### Fixed tool box with 6 drawers

- Ball bearing slidings with telescopic system
- Central closing system
- Drawers equipped with internal rubber mat
- Drawers' dimension valid for tool forms

CODE	WEIGHT	€/Pz
FG 116/68V6	58,00 Kg	820,00

NEW



### Fixed tool box with 7 drawers

- Ball bearing slidings with telescopic system
- Central closing system
- Drawers equipped with internal rubber mat
- Drawers' dimension valid for tool forms

CODE	WEIGHT	€/Pz
FG 116/68V7	57,00 Kg	850,00

# TROLLEYS



**NEW**

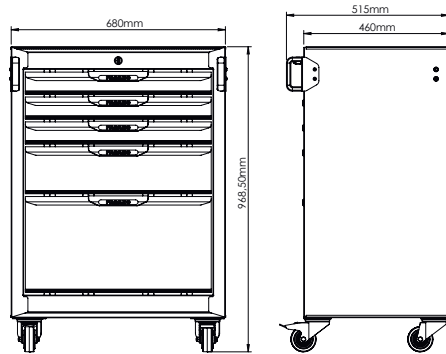

## Mobile tool box with 5 drawers

- Ball bearing slidings with telescopic system
- Central closing system
- Drawers equipped with internal rubber mat
- Drawers' dimension valid for tool forms

CODE	WEIGHT	€/Pz
FG 116V/5G	53,00 Kg	<b>750,00</b>



**NEW**

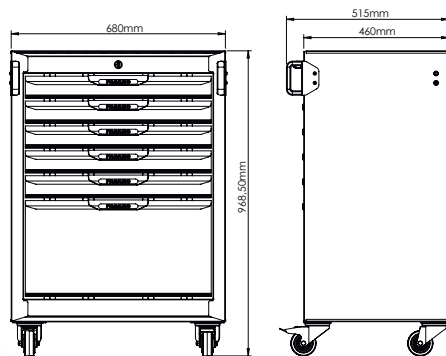

## Mobile tool box with 6 drawers

- Ball bearing slidings with telescopic system
- Central closing system
- Drawers equipped with internal rubber mat
- Drawers' dimension valid for tool forms

CODE	WEIGHT	€/Pz
FG 116V/6G	52,00 Kg	<b>780,00</b>



**NEW**

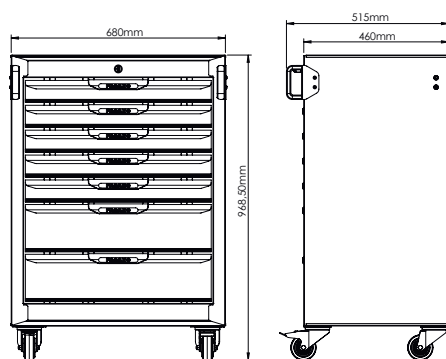

## Mobile tool box with 7 drawers

- Ball bearing slidings with telescopic system
- Central closing system
- Drawers equipped with internal rubber mat
- Drawers' dimension valid for tool forms

CODE	WEIGHT	€/Pz
FG 116V/7G	51,00 Kg	<b>800,00</b>



**NEW MODULES**  
**VANS FURNITURE**



WOODEN WORKTOP



REMOVABLE WORK BENCH  
PORTAMORSA



NON-SLIP FLOORS



## THE WORK ON THE ROAD

### Vans furniture!

Fasano Tools technical furniture dedicated to equipped vehicles  
it adapts perfectly to tastes and needs.  
Choose the ideal color and composition!



POLES STOP LOAD



ESSENTIAL ACCESSORIES



DRAWERS PREPARED FOR  
THE INSERTION OF FORMS  
EQUIPPED WITH TOOLS



# 16 INDUSTRIAL FURNITURE

FG 119/RP30-67

+ FG 119/M30-40

FG 119/RV30-67

FG 119/RV40-67

+ FG 119/M40-23

FG 119V/C73-3

FG 119V/BA73

FG 119/RI73



## Vans furniture combination

Dimensions: 735x400x1.592mm

CODE	WEIGHT	€/Pz	NEW
FG 119V/CO1	53,8 Kg	2.015,00	



FG 119B/CO1



FG 119R/CO1

FG 119/RV30-67

+ FG 119/M30-40

FG 119/RP30-67

FG 119/RP40-67

+ FG 119/M40-23

FG 119V/C73-3

FG 119V/BA73

FG 119/RI73

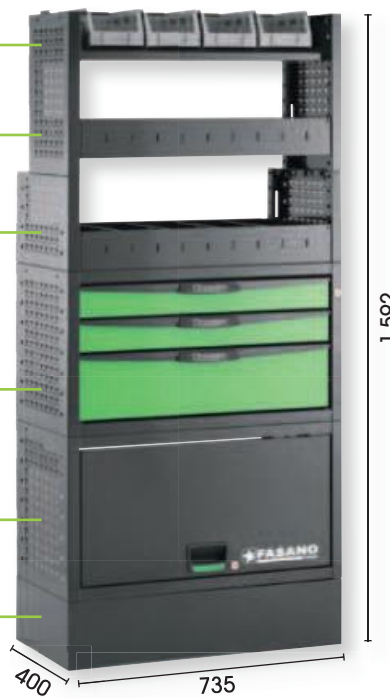

## Vans furniture combination

Dimensions: 735x400x1.592mm

CODE	WEIGHT	€/Pz	NEW
FG 119V/CO2	53,2 Kg	2.020,00	

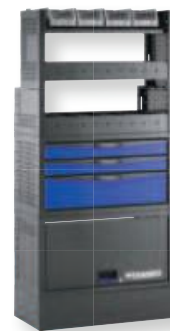

FG 119B/CO2



FG 119R/CO2

FG 119/RP30-67

+ FG 119/M30-40

FG 119/RV30-67

FG 119V/C73-3

FG 119V/BA73

FG 119/RI73



## Vans furniture combination

Dimensions: 735x400x1.360mm

CODE	WEIGHT	€/Pz	NEW
FG 119V/CO3	46,4 Kg	1.750,00	



FG 119B/CO3



FG 119R/CO3

FG 119/RV30-67

+ FG 119/MRT30-9

FG 119V/C73-3

FG 119V/BA73

FG 119/RI73



### Vans furniture combination

Dimensions: 735x400x1.092mm

CODE	WEIGHT	€/Pz
FG 119V/CO4	40,9 Kg	<b>1.530,00</b>

**NEW**



FG 119B/CO4



FG 119R/CO4

FG 119/RP40-67

+ FG 119/MRT40-9

FG 119V/C73-3

FG 119V/BA73

FG 119/RI73



### Vans furniture combination

Dimensions: 735x400x1.057mm

CODE	WEIGHT	€/Pz
FG 119V/CO5	42,26Kg	<b>1.570,00</b>

**NEW**



FG 119B/CO5



FG 119R/CO5

FG 119/RP20-67 x2

+ FG 119/MRT20-9 x2

FG 119V/C73-3

FG 119V/BA73

FG 119/RI73



### Vans furniture combination

Dimensions: 735x400x1.057mm

CODE	WEIGHT	€/Pz
FG 119V/CO6	43,9Kg	<b>1.650,00</b>

**NEW**



FG 119B/CO6



FG 119R/CO6





# 16 INDUSTRIAL FURNITURE

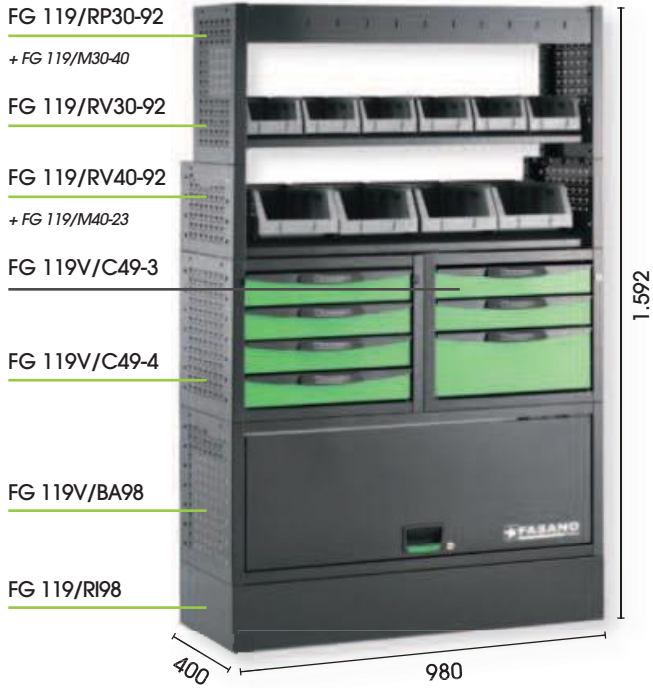

## Vans furniture combination

Dimensions: 980x400x1.592mm

CODE	WEIGHT	€/Pz
FG 119V/CO11	75,6 Kg	2.900,00

NEW



FG 119B/CO11

FG 119R/CO11

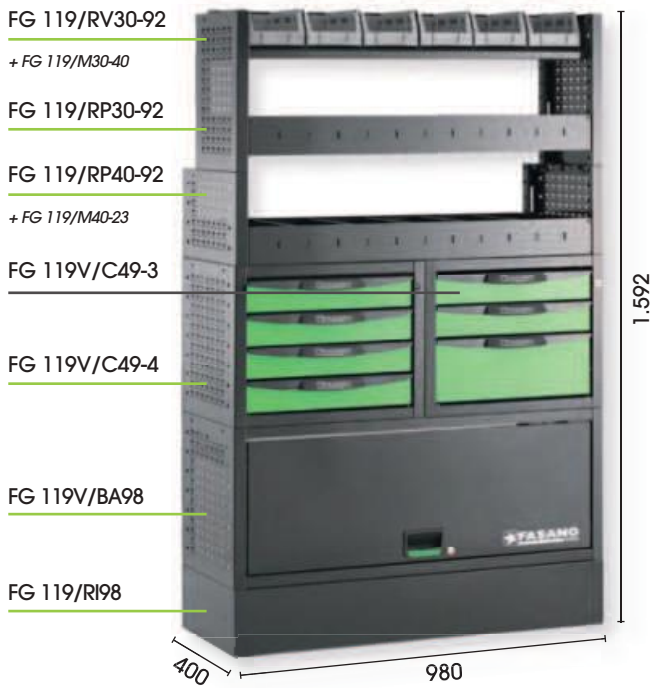

## Vans furniture combination

Dimensions: 980x400x1.592mm

CODE	WEIGHT	€/Pz
FG 119V/CO12	74,9 Kg	2.920,00

NEW



FG 119B/CO12

FG 119R/CO12



## Vans furniture combination

Dimensions: 980x400x1.592mm

CODE	WEIGHT	€/Pz
FG 119M/CO13	40,4 Kg	1.540,00

NEW



COMPARTMENTS FOR TOOLS

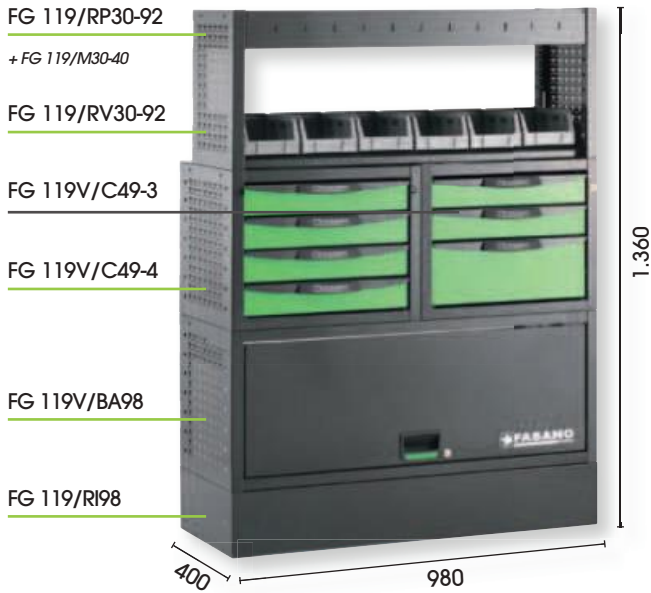

### Vans furniture combination

Dimensions: 980x400x1.360mm

CODE	WEIGHT	€/Pz
FG 119V/CO14	66,6 Kg	<b>2.620,00</b>

**NEW**



FG 119B/CO14



FG 119R/CO14

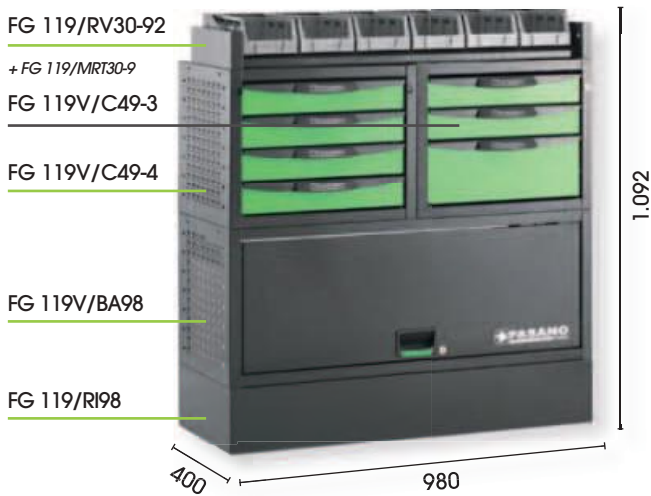

### Vans furniture combination

Dimensions: 980x400x1.092mm

CODE	WEIGHT	€/Pz
FG 119V/CO15	59,9 Kg	<b>2.360,00</b>

**NEW**



FG 119B/CO15



FG 119R/CO15

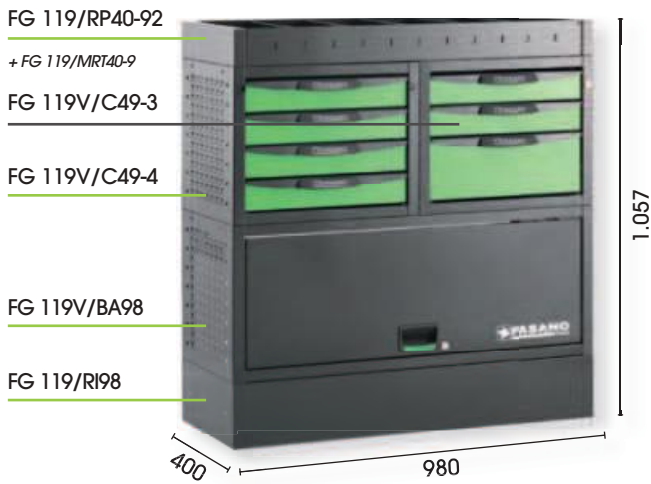

### Vans furniture combination

Dimensions: 980x400x1.057mm

CODE	WEIGHT	€/Pz
FG 119V/CO16	61,8 Kg	<b>2.400,00</b>

**NEW**



FG 119B/CO16



FG 119R/CO16

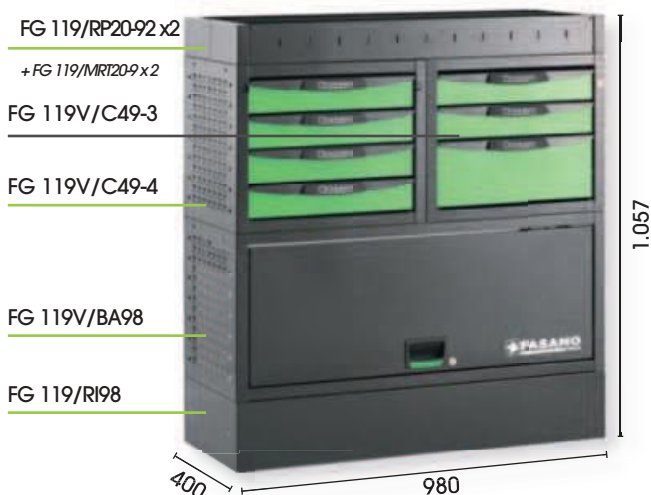

### Vans furniture combination

Dimensions: 980x400x1.057mm

CODE	WEIGHT	€/Pz
FG 119V/CO17	63,6 Kg	<b>2.500,00</b>

**NEW**



FG 119B/CO17



FG 119R/CO17



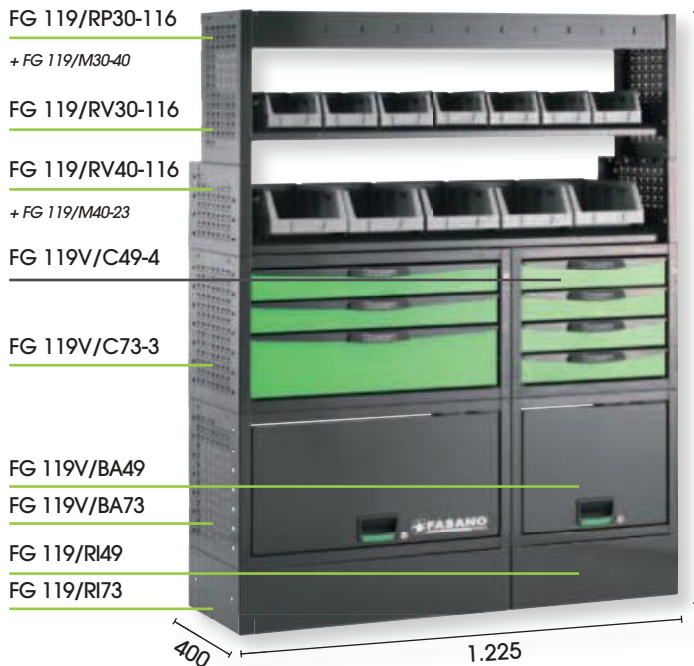

## Vans furniture combination

Dimensions: 1.225x400x1.592mm

CODE	WEIGHT	€/Pz
FG 119V/CO21	92,4 Kg	3.470,00

NEW



FG 119B/CO21



FG 119R/CO21

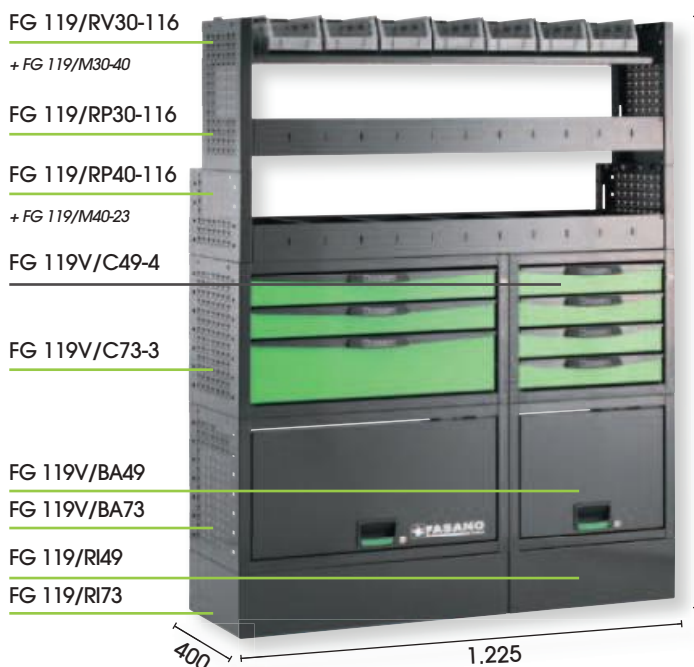

## Vans furniture combination

Dimensions: 1.225x400x1.592mm

CODE	WEIGHT	€/Pz
FG 119V/CO22	91,2 Kg	3.470,00

NEW



FG 119B/CO22



FG 119R/CO22

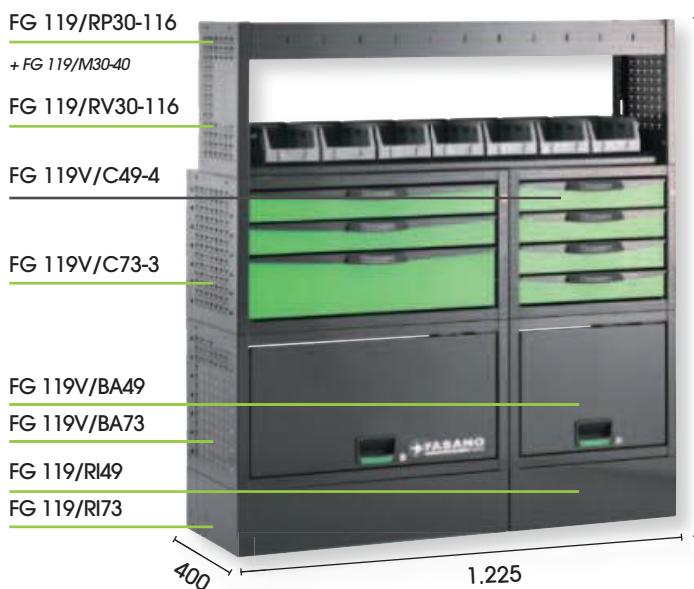

## Vans furniture combination

Dimensions: 1.225x400x1.360mm

CODE	WEIGHT	€/Pz
FG 119V/CO23	81,8 Kg	3.150,00

NEW



FG 119B/CO23



FG 119R/CO23

### Vans furniture combination

Dimensions: 1.225x400x1.092mm

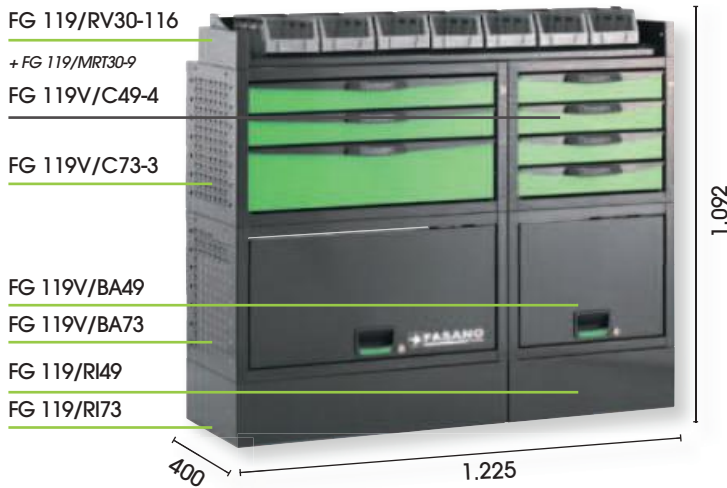

CODE	WEIGHT	€/Pz
FG 119V/CO24	74,1 Kg	2.890,00

NEW



FG 119B/CO24

FG 119R/CO24

### Vans furniture combination

Dimensions: 1.225x400x1.057mm

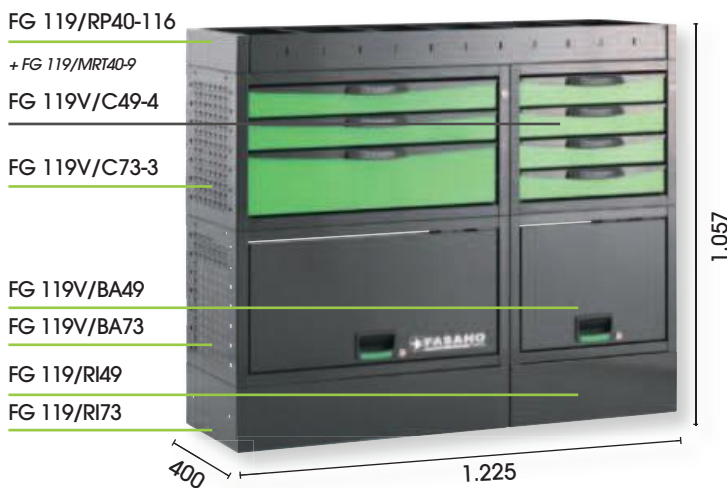

CODE	WEIGHT	€/Pz
FG 119V/CO25	76,2 Kg	2.930,00

NEW



FG 119B/CO25

FG 119R/CO25

### Vans furniture combination

Dimensions: 1.225x400x1.057mm

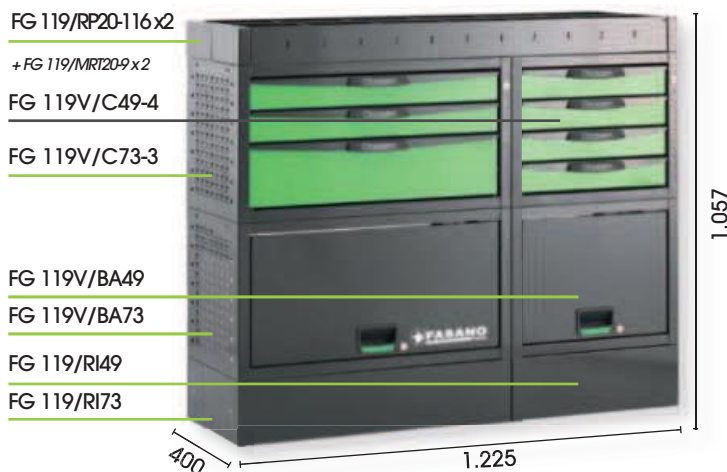

CODE	WEIGHT	€/Pz
FG 119V/CO26	78,3 Kg	3.050,00

NEW



FG 119B/CO26

FG 119R/CO26



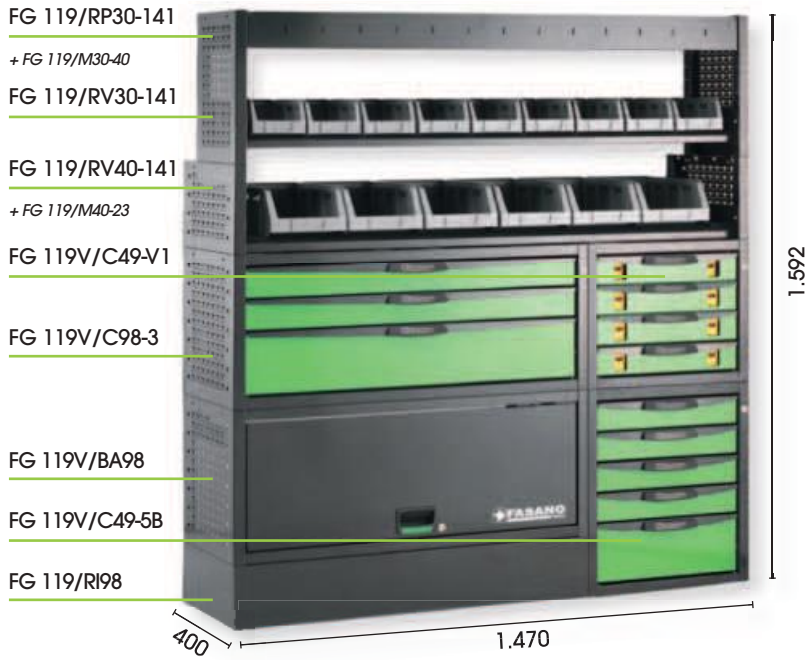

## Vans furniture combination

Dimensions: 1.470x400x1.592mm

CODE	WEIGHT	€/Pz
FG 119V/CO31	126,2 kg	4.500,00

NEW



FG 119B/CO31



FG 119R/CO31

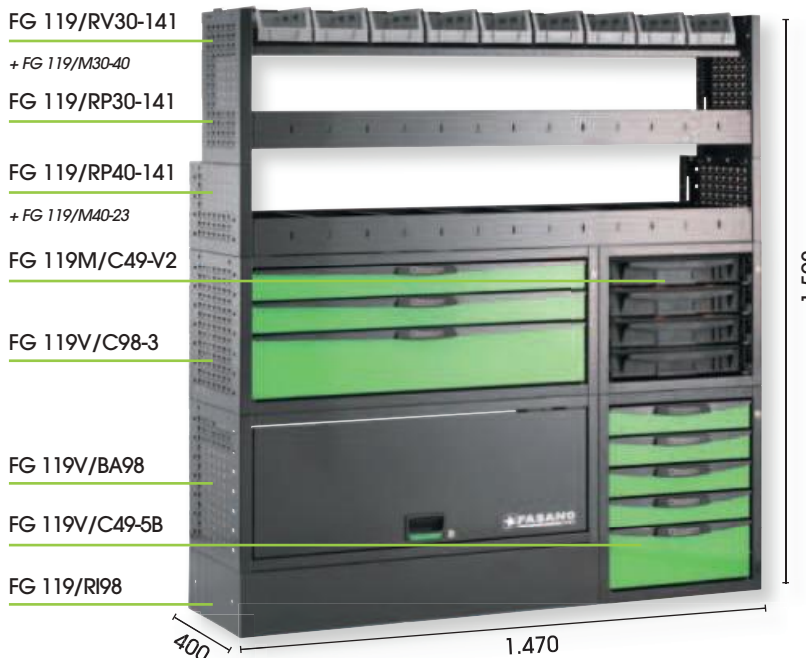

## Vans furniture combination

Dimensions: 1.470x400x1.592mm

CODE	WEIGHT	€/Pz
FG 119V/CO32	113,9 Kg	4.170,00

NEW



FG 119B/CO32



FG 119R/CO32

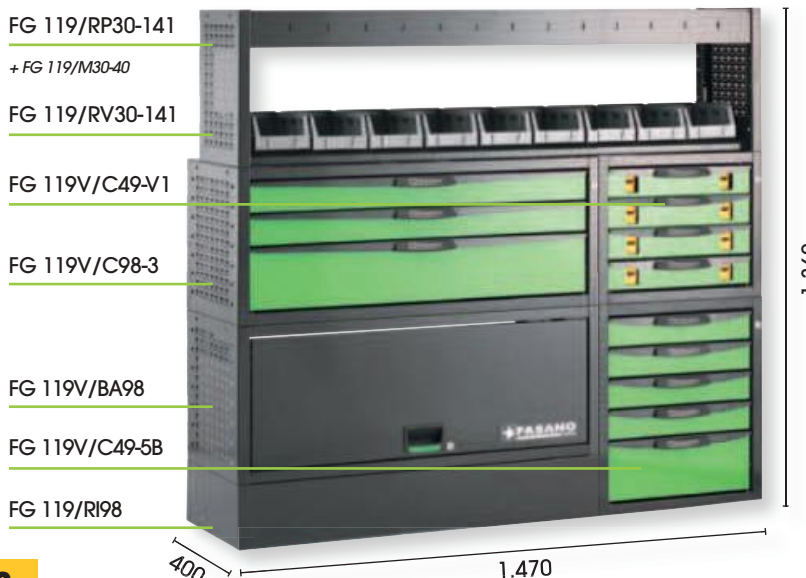

## Vans furniture combination

Dimensions: 1.470x400x1.360mm

CODE	WEIGHT	€/Pz
FG 119V/CO33	114 Kg	4.170,00

NEW



FG 119B/CO33



FG 119R/CO33

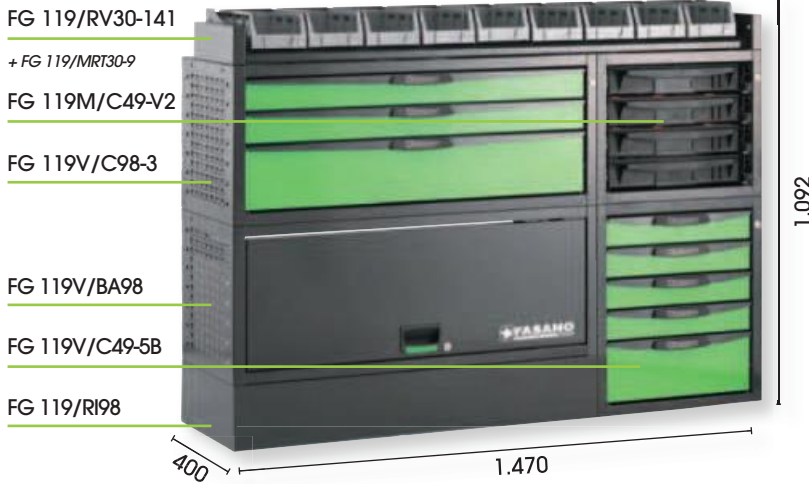

**Vans furniture combination**

Dimensions: 1.470x400x1.092mm

CODE	WEIGHT	€/Pz
FG 119V/CO34	94,1 Kg	<b>3.530,00</b>

NEW



FG 119B/CO34



FG 119R/CO34

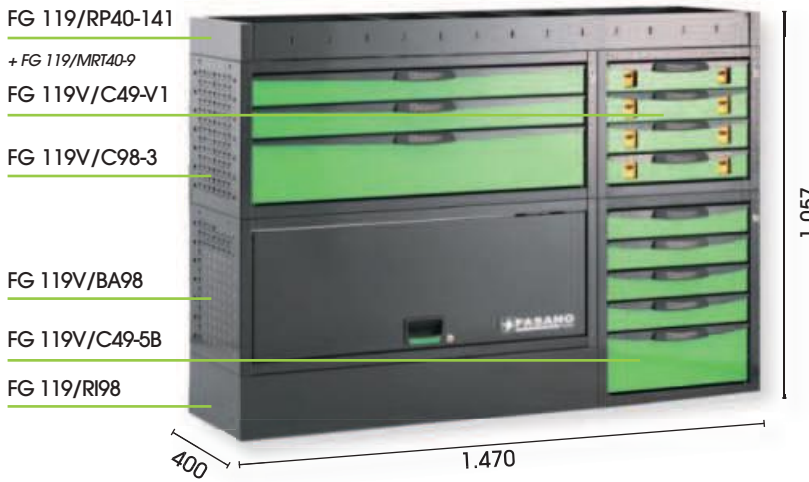

**Vans furniture combination**

Dimensions: 1470x400x1.057mm

CODE	WEIGHT	€/Pz
FG 119V/CO35	107,3 Kg	<b>3.950,00</b>

NEW



FG 119B/CO35



FG 119R/CO35

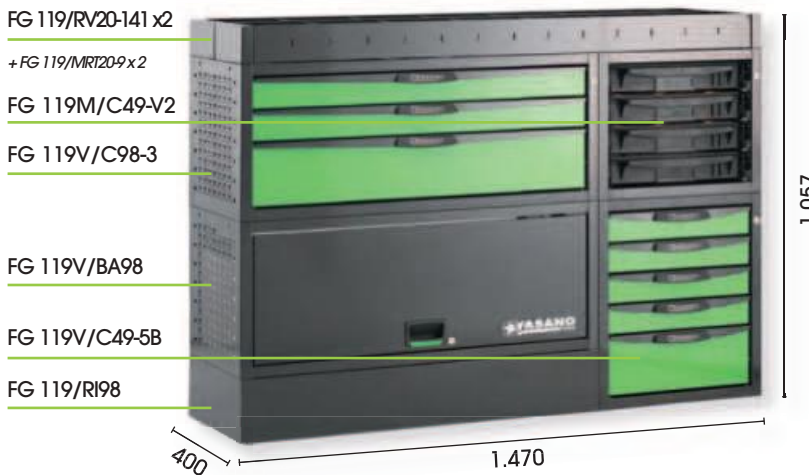

**Vans furniture combination**

Dimensions: 1.470x400x1.057mm

CODE	WEIGHT	€/Pz
FG 119V/CO36	98,9 Kg	<b>3.700,00</b>

NEW



FG 119B/CO36



FG 119R/CO36



TECHNICAL FURNITURE MODULES WITH WORTOP



**Wooden worktop**  
*Poplar plywood*

CODE	DIMENSIONS	WEIGHT	€/Pz
FG 119/49TL	490x18x400mm	1,6Kg	<b>130,00</b>
FG 119/73TL	735x18x400mm	2,4Kg	<b>220,00</b>
FG 119/98TL	980x18x400mm	3,2Kg	<b>290,00</b>

NEW

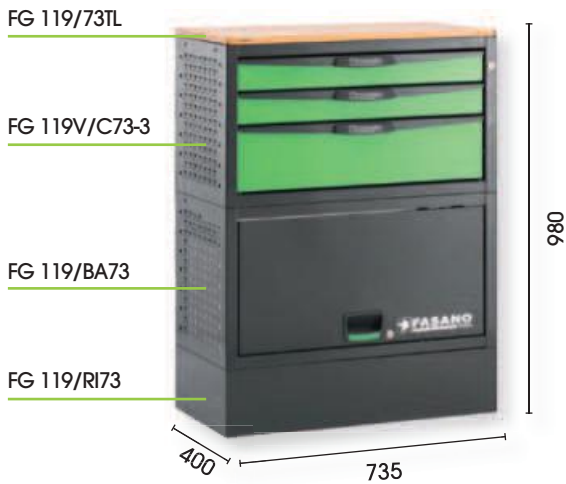

**Vans furniture combination**

Dimensions: 735x400x980mm

CODE	WEIGHT	€/Pz
FG 119V/CO7	38,9 kg	<b>1.580,00</b>

NEW



FG 119B/CO7



FG 119R/CO7

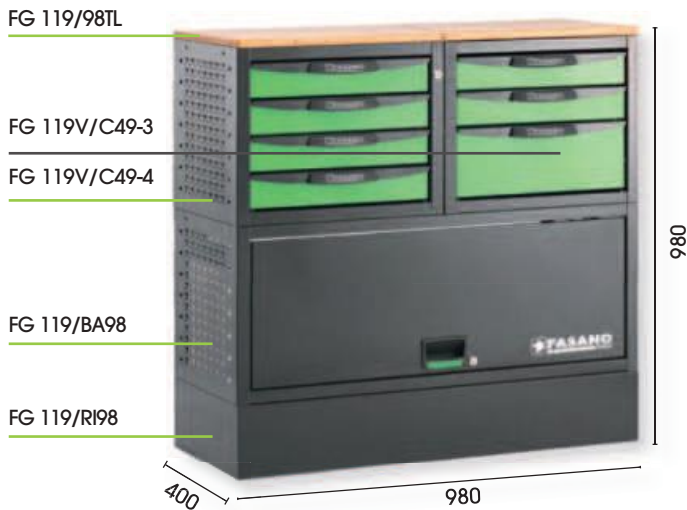

**Vans furniture combination**

Dimensions: 980x400x980mm

CODE	WEIGHT	€/Pz
FG 119V/CO18	56,5 Kg	<b>2.460,00</b>

NEW



FG 119B/CO18



FG 119R/CO18

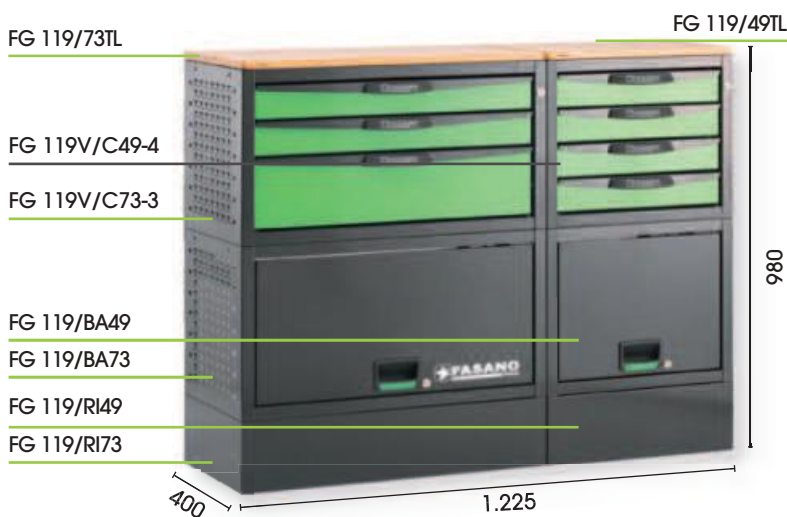

**Vans furniture combination**

Dimensions: 1.225x400x980mm

CODE	WEIGHT	€/Pz
FG 119V/CO27	71,6 Kg	<b>3.040,00</b>

NEW



FG 119B/CO27



FG 119R/CO27





THE MODULAR SOLUTION FOR COMPOSING  
THE FURNITURE OF YOUR VAN

within 3 easy STEP



STEP

BASE

1°

SELECT THE BASE:

- **OPEN** (IF POSITIONED ON THE WHEEL ARCH)  
OR **CLOSED**
- **EVENTUAL RISE**



STEP

DRAWERS

2°

SELECT THE TOOL CHEST

(TYPE AND NUMBER OF DRAWER UNITS VARY  
ACCORDING TO FUNCTION OF THE WIDTH OF THE BASE)



STEP

SHELVES

3°

ADD EVENTUAL **SHELVES**  
WITH RELATED **SIDE UPRIGHTS**

(KEEP IN MIND THE DEPTH OF THE STRUCTURE  
AND THE SHAPE OF THE VAN)

## RISERS

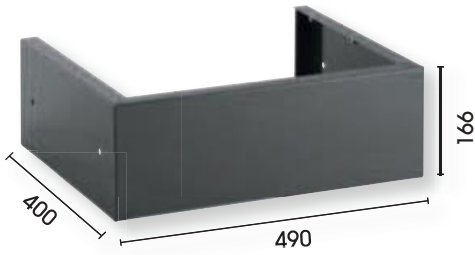

### Riser for open or closed bases

Dimensions: 490x400x166mm

CODE	WEIGHT	€/Pz	NEW
FG 119/RI49	2,4 Kg	50,00	

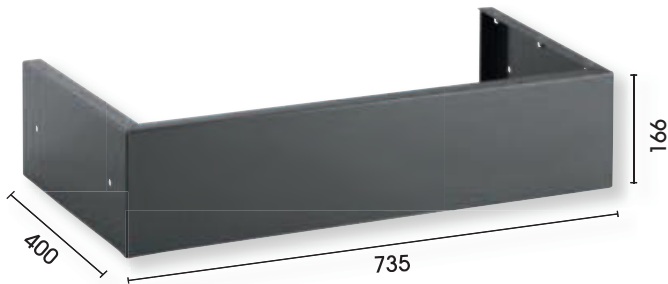

### Riser for open or closed bases

Dimensions: 735x400x166mm

CODE	WEIGHT	€/Pz	NEW
FG 119/RI73	2,8 Kg	55,00	

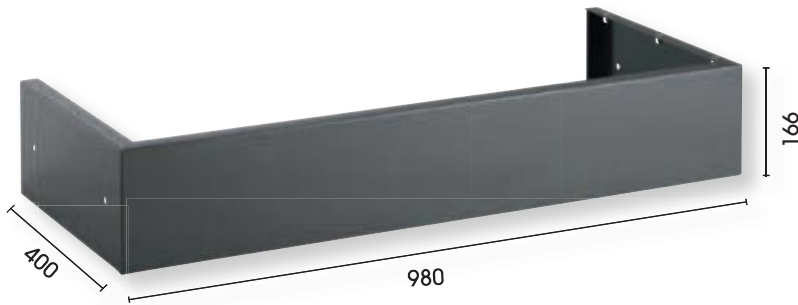

### Riser for open or closed bases

Dimensions: 980x400x166mm

CODE	WEIGHT	€/Pz	NEW
FG 119/RI98	3,2 Kg	65,00	

## OPEN BASES



### Open base

To be placed on the wheel arch

Dimensions: 490x400x398mm

CODE	WEIGHT	€/Pz	NEW
FG 119V/BA49	7,7 Kg	380,00	



FG 119B/BA49

FG 119R/BA49



### Open base

To be placed on the wheel arch

Dimensions: 735x400x398mm

CODE	WEIGHT	€/Pz	NEW
FG 119V/BA73	9,6 Kg	410,00	



FG 119B/BA73

FG 119R/BA73



# 16 INDUSTRIAL FURNITURE



## Open base

To be placed on the wheel arch  
Dimensions: 980x400x398mm

CODE	WEIGHT	€/Pz
FG 119V/BA98	11,5Kg	460,00



FG 119B/BA98



FG 119R/BA98

## CLOSED BASES

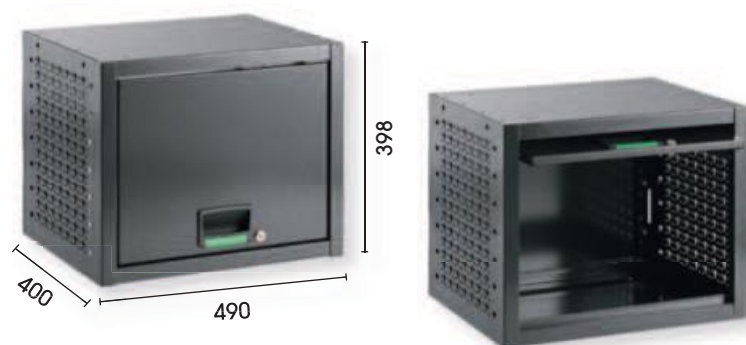

## Closed base

Dimensions: 490x400x398mm

CODE	WEIGHT	€/Pz
FG 119V/BC49	10,7 Kg	430,00



FG 119B/BC49



FG 119R/BC49



## Closed base

Dimensions: 735x400x398mm

CODE	WEIGHT	€/Pz
FG 119V/BC73	14,1 Kg	470,00



FG 119B/BC73



FG 119R/BC73



## Closed base

Dimensions: 980x400x398mm

CODE	WEIGHT	€/Pz
FG 119V/BC98	17,5 Kg	540,00



FG 119B/BC98



FG 119R/BC98

## CASE HOLDER BASES



### Base without riser

Dimensions: 980x400x398mm

CODE	WEIGHT	€/Pz
FG 119/BV98	8,7 Kg	350,00

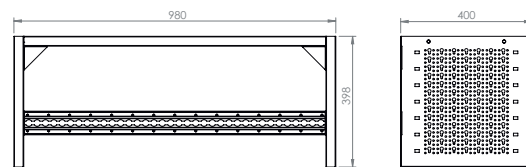
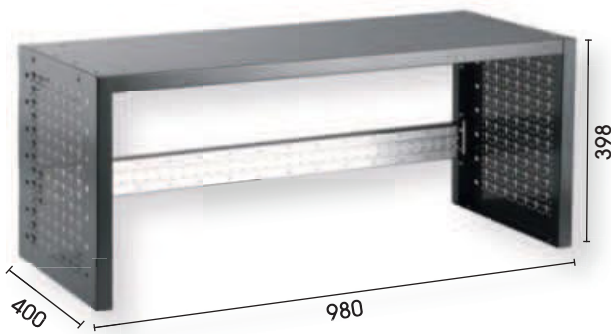

### Base with riser

Dimensions: 980x400x564mm

CODE	WEIGHT	€/Pz
FG 119/BV98-2	11,9 Kg	410,00

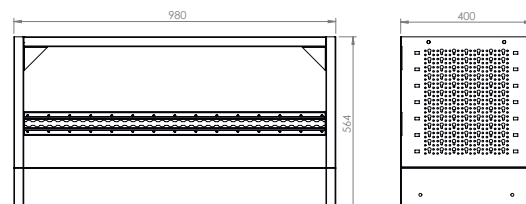

### Base with riser

Dimensions: 980x400x564mm

CODE	WEIGHT	€/Pz
FG 119/BV98-3	10,2 Kg	340,00

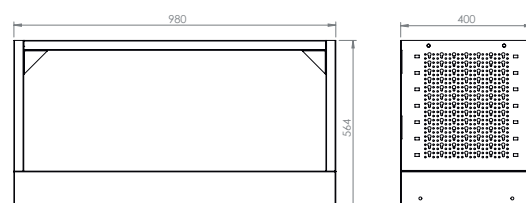

## BASI DOTATE DI CASSETTI



**Base with 3 drawers**  
Dimensions: 490x400x564mm

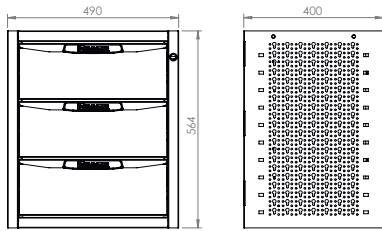

CODE	WEIGHT	€/Pz
FG 119V/C49-3B	22,7 Kg	850,00



FG 119B/C49-3B



FG 119R/C49-3B



**Base with 4 drawers**  
Dimensions: 490x400x564mm

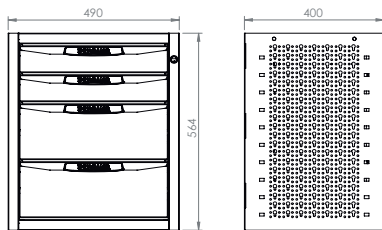

CODE	WEIGHT	€/Pz
FG 119V/C49-4B	24,9 Kg	940,00



FG 119B/C49-4B



FG 119R/C49-4B



**Base with 5 drawers**  
Dimensions: 490x400x564mm

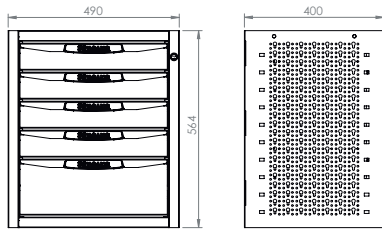

CODE	WEIGHT	€/Pz
FG 119V/C49-5B	27,1 Kg	1.020,00



FG 119B/C49-5B



FG 119R/C49-5B



**Base with 6 drawers**  
Dimensions: 490x400x564mm

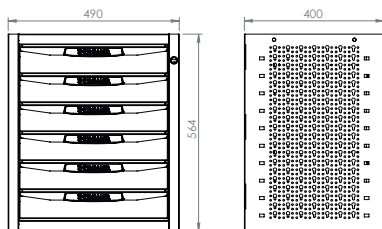

CODE	WEIGHT	€/Pz
FG 119V/C49-6B	29,3 Kg	1.100,00



FG 119B/C49-6B



FG 119R/C49-6B



**Base with 6 drawers and ABS boxes for pieces**  
Dimensions: 490x400x564mm

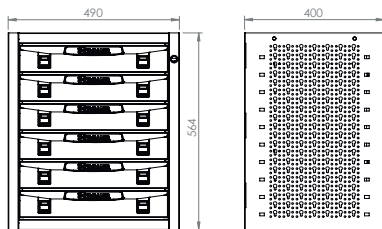

CODE	WEIGHT	€/Pz
FG 119V/C49-VB	36,8 Kg	1.450,00



FG 119B/C49-VB



FG 119R/C49-VB

# MODULO CASSETTIERA



## Tool chest with 2 drawers

Dimensions: 490x400x398mm

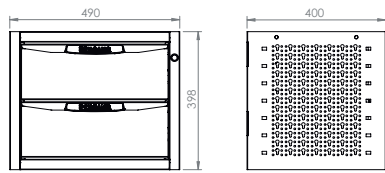

CODE	WEIGHT	€/Pz
FG 119V/C49-2	16,6 Kg	<b>630,00</b>



FG 119B/C49-2



FG 119R/C49-2



## Tool chest with 3 drawers

Dimensions: 490x400x398mm

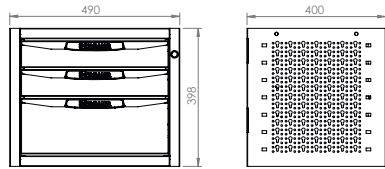

CODE	WEIGHT	€/Pz
FG 119V/C49-3	18,7 Kg	<b>710,00</b>



FG 119B/C49-3



FG 119R/C49-3



## Tool chest with 4 drawers

Dimensions: 490x400x398mm

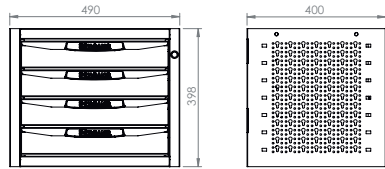

CODE	WEIGHT	€/Pz
FG 119V/C49-4	20,9 Kg	<b>800,00</b>



FG 119B/C49-4



FG 119R/C49-4



## Tool chest with 4 drawers and ABS boxes for pieces

Dimensions: 490x400x398mm

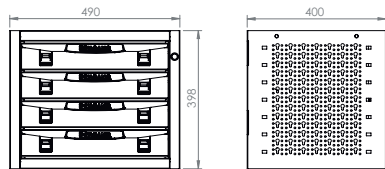

CODE	WEIGHT	€/Pz
FG 119V/C49-V1	26,0 Kg	<b>1.030,00</b>



FG 119B/C49-V1



FG 119R/C49-V1



DRAWER WITH TOTAL OPENING



INTERNAL CASES FOR SMALL PARTS



CASE LOCKING SYSTEM



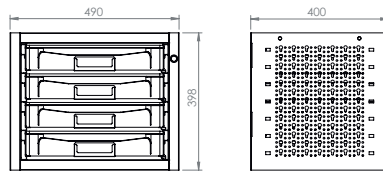

### Tool chest with ABS boxes for pieces

Dimensions: 490x400x398mmmm

CODE	WEIGHT	€/Pz
FG 119M/C49-V2	15,1 kg	660,00



CASSETTO CON APERTURA TOTALE



CHIUSURA LATERALE CENTRALIZZATA



BOX INTERNI PORTA MINUTERIE

### Tool chest with 2 drawers

Dimensions: 735x400x398mmmm

CODE	WEIGHT	€/Pz
FG 119V/C73-2	21,2 Kg	700,00

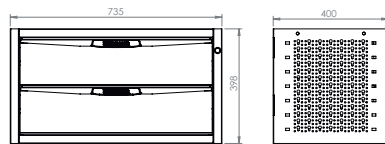

FG 119B/C73-2



FG 119R/C73-2

### Tool chest with 3 drawers

Dimensions: 735x400x398mmmm

CODE	WEIGHT	€/Pz
FG 119V/C73-3	24,1 Kg	800,00

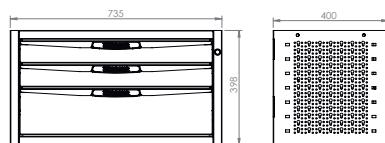

FG 119B/C73-3



FG 119R/C73-3

### Tool chest with 4 drawers

Dimensions: 735x400x398mmmm

CODE	WEIGHT	€/Pz
FG 119V/C73-4	27,0 Kg	900,00

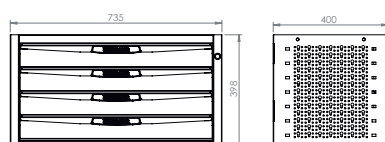

FG 119B/C73-4



FG 119R/C73-4

**Tool chest with 2 drawers**

Dimensions: 980x400x398mm

CODE	WEIGHT	€/Pz
FG 119V/C98-2	25,8 Kg	<b>790,00</b>

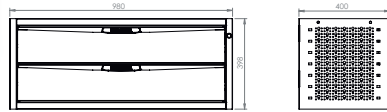

FG 119B/C98-2



FG 119R/C98-2

**Tool chest with 3 drawers**

Dimensions: 980x400x398mm

CODE	WEIGHT	€/Pz
FG 119V/C98-3	29,5 Kg	<b>900,00</b>

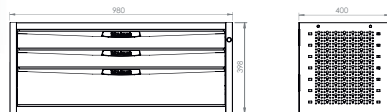
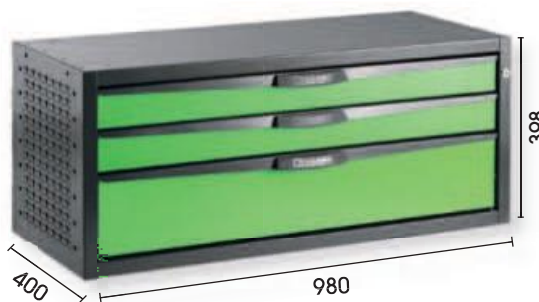

FG 119B/C98-3



FG 119R/C98-3

**Tool chest with 4 drawers**

Dimensions: 980x400x398mm

CODE	WEIGHT	€/Pz
FG 119V/C98-4	33,1 Kg	<b>1.020,00</b>

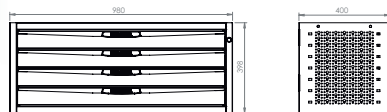

FG 119B/C98-4



FG 119R/C98-4

**TOOL CHEST EQUIPPED WITH ABS CASES**

**Tool chest with 4 removable and stackable ABS cases**

Dimensions: 980x400x398mm

CODE	WEIGHT	€/Pz
FG 119M/C98-V	27,0 Kg	<b>1.190,00</b>

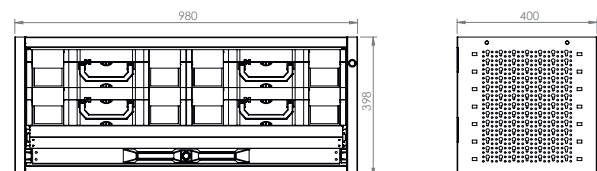

TOTAL OPENING 4 STACKABLE CASES



CASE HOOK



CASES EQUIPPED WITH INTERNAL BOXES FOR SMALL PARTS





## SHELVES WITH REMOVABLE DIVIDERS

CODE	N.OF DIVIDERS	WEIGHT	€/Pz
FG 119/RP40-67	4 - FG 119/D40	5,1 Kg	130,00

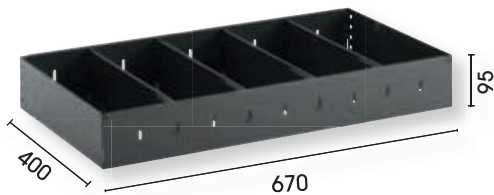

CODE	N.OF DIVIDERS	WEIGHT	€/Pz
FG 119/RP40-116	5 - FG 119/D40	7,7 kg	170,00



CODE	N.OF DIVIDERS	WEIGHT	€/Pz
FG 119/RP30-67	4 - FG 119/D30	4,1 Kg	110,00

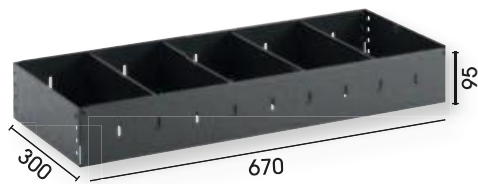

CODE	N.OF DIVIDERS	WEIGHT	€/Pz
FG 119/RP30-116	5 - FG 119/D30	6,3 Kg	150,00

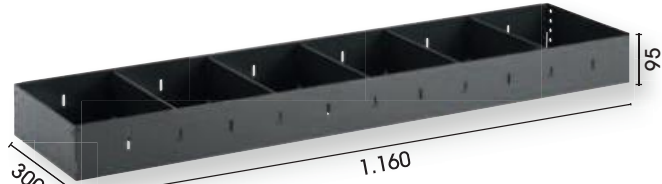

CODE	N.OF DIVIDERS	WEIGHT	€/Pz
FG 119/RP20-67	4 - FG 119/D20	3,1 Kg	85,00

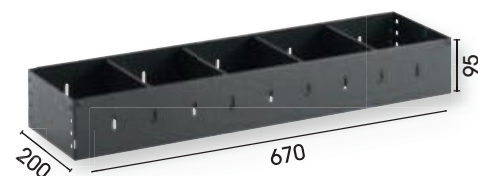

CODE	N.OF DIVIDERS	WEIGHT	€/Pz
FG 119/RP20-116	5 - FG 119/D20	4,8 Kg	120,00

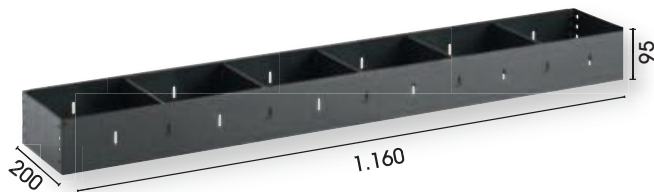

CODE	N.OF DIVIDERS	WEIGHT	€/Pz
FG 119/RP40-92	5 - FG 119/D40	6,6 Kg	160,00



CODE	N.OF DIVIDERS	WEIGHT	€/Pz
FG 119/RP40-141	6 - FG 119/D40	9,2 Kg	200,00



CODE	N.OF DIVIDERS	WEIGHT	€/Pz
FG 119/RP30-92	5 - FG 119/D30	5,3 Kg	140,00

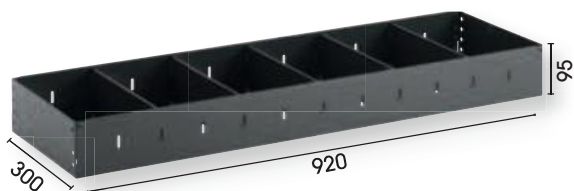

CODE	N.OF DIVIDERS	WEIGHT	€/Pz
FG 119/RP30-141	6 - FG 119/D30	7,5 Kg	175,00



CODE	N.OF DIVIDERS	WEIGHT	€/Pz
FG 119/RP20-92	5 - FG 119/D20	4,1 Kg	120,00

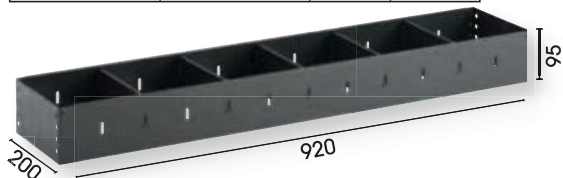

CODE	N.OF DIVIDERS	WEIGHT	€/Pz
FG 119/RP20-141	6 - FG 119/D20	5,8 Kg	140,00

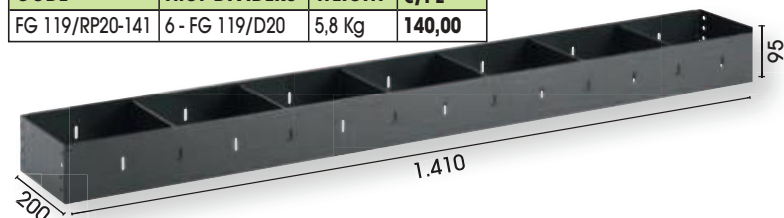

## SHELVES WITH TRAYS DIVIDERS

CODE	N.OF TRAYS	WEIGHT	€/Pz
FG 119/RV40-67	3 - FG 119/VA40	5,6 Kg	<b>130,00</b>

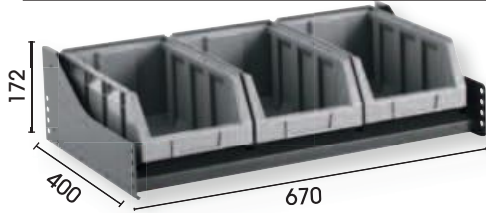

CODE	N.OF TRAYS	WEIGHT	€/Pz
FG 119/RV40-116	5 - FG 119/VA40	8,9 Kg	<b>180,00</b>

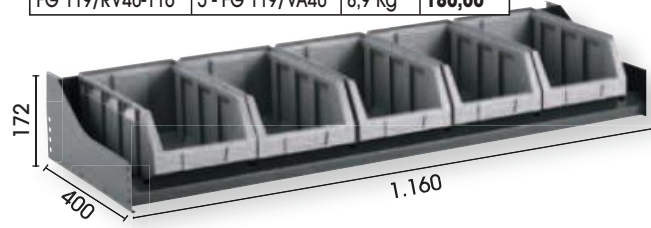

CODE	N.OF TRAYS	WEIGHT	€/Pz
FG 119/RV30-67	4 - FG 119/VA30	3,7 Kg	<b>95,00</b>



CODE	N.OF TRAYS	WEIGHT	€/Pz
FG 119/RV30-116	7 - FG 119/VA30	5,9 Kg	<b>135,00</b>

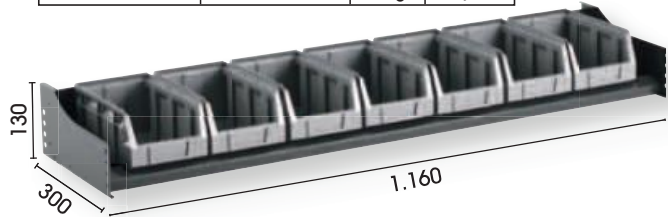

CODE	N.OF TRAYS	WEIGHT	€/Pz
FG 119/RV20-67	6 - FG 119/VA20	2,5 Kg	<b>90,00</b>



CODE	N.OF TRAYS	WEIGHT	€/Pz
FG 119/RV20-116	10 - FG 119/VA20	3,9 Kg	<b>125,00</b>

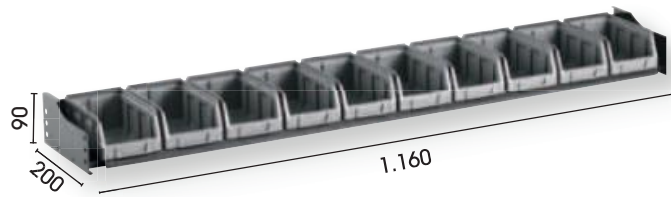

CODE	N.OF TRAYS	WEIGHT	€/Pz
FG 119/RP40-92	4 - FG 119/VA40	7,3	<b>150,00</b>



CODE	N.OF TRAYS	WEIGHT	€/Pz
FG 119/RV40-141	6 - FG 119/VA40	10,6 Kg	<b>210,00</b>



CODE	N.OF TRAYS	WEIGHT	€/Pz
FG 119/RV30-92	6 - FG 119/VA30	4,9 Kg	<b>135,00</b>



CODE	N.OF TRAYS	WEIGHT	€/Pz
FG 119/RV30-141	9 - FG 119/VA30	7,1 Kg	<b>160,00</b>

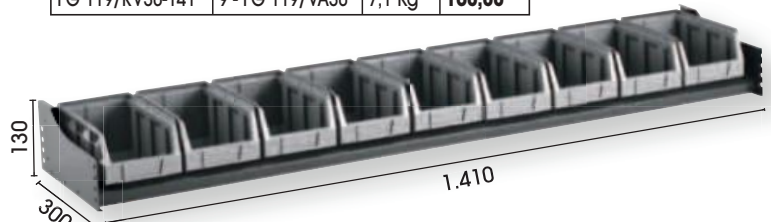

CODE	N.OF TRAYS	WEIGHT	€/Pz
FG 119/RV20-92	8 - FG 119/VA20	3,2 Kg	<b>115,00</b>



CODE	N.OF TRAYS	WEIGHT	€/Pz
FG 119/RV20-141	12 - FG 119/VA20	4,7 Kg	<b>140,00</b>



# 16 INDUSTRIAL FURNITURE

## TRAYS

### Plastic trays

Dimensions: 105x167x82mm

Capacity: 3,12Kg

Weight: 0,1Kg

CODE	€/Pz
FG 119/VA20	2,00

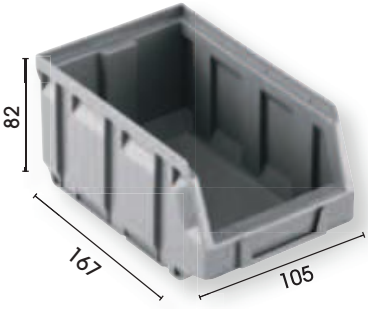

### Plastic trays

Dimensions: 205x345x164mm

Capacity: 20,60Kg

Weight: 0,6Kg

CODE	€/Pz
FG 119/VA40	13,00

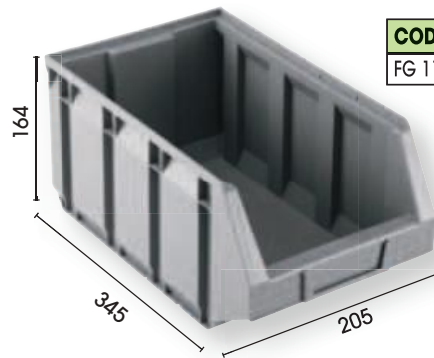

### Plastic trays

Dimensions: 144x237x123mm

Capacity: 10,30kg

Weight: 0,2Kg

CODE	€/Pz
FG 119/VA30	5,00

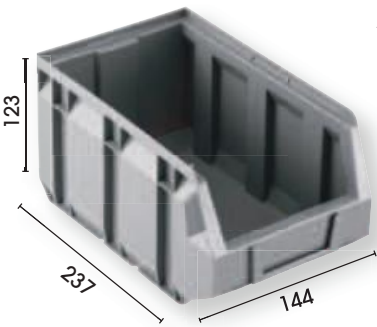

## REMOVABLE DIVIDERS



### Dividers for shelves

Dimensions: 290x91mm

Weight: 0,24Kg

CODE	€/Pz
FG 119/D30	12,00

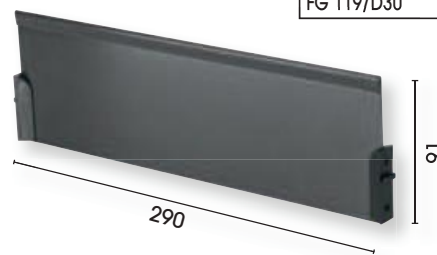

### Dividers for shelves

Dimensions: 190x91mm

Weight: 0,15Kg

CODE	€/Pz
FG 119/D20	9,00



### Dividers for shelves

Dimensions: 390x91mm

Weight: 0,32kg

CODE	€/Pz
FG 119/D40	14,00



# COUPLE OF SIDE UPRIGHTS

CODE	€/Pz
FG 119/M40-23	132,00

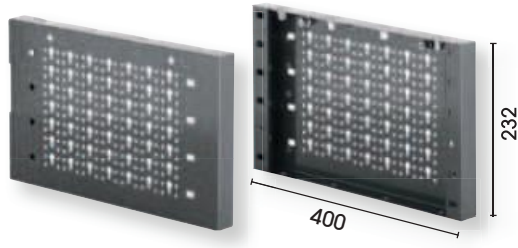

**WEIGHT:**  
1,7Kg

CODE	€/Pz
FG 119/M40-40	194,00

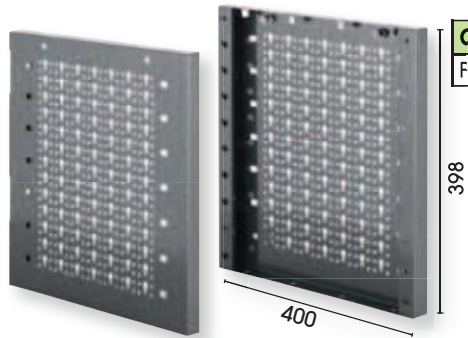

**WEIGHT:**  
2,7Kg

CODE	€/Pz
FG 119/M40-56	268,00

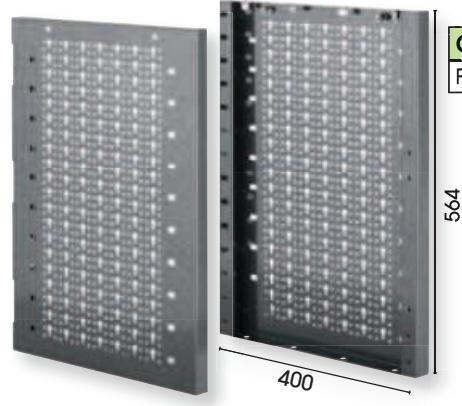

**WEIGHT:**  
3,6Kg

CODE	€/Pz
FG 119/M30-23	116,00

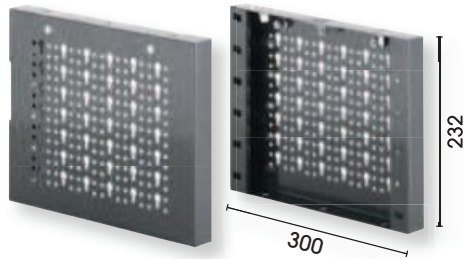

**WEIGHT:**  
1,4Kg

CODE	€/Pz
FG 119/M30-40	167,00

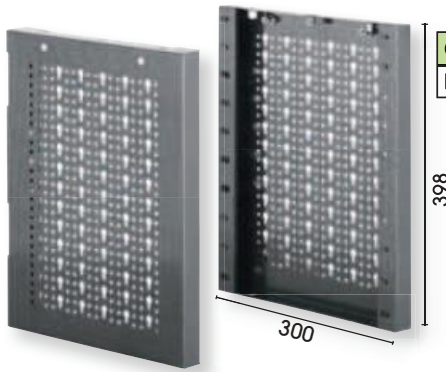

**WEIGHT:**  
2,2Kg

CODE	€/Pz
FG 119/M20-23	87,00



**WEIGHT:**  
1,0Kg

CODE	€/Pz
FG 119/M20-40	130,00

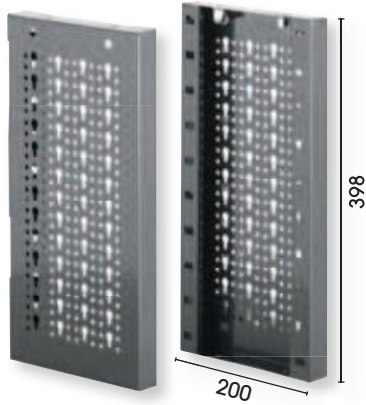

**WEIGHT:**  
1,7Kg

CODE	€/Pz
FG 119/MRT20-9	66,00

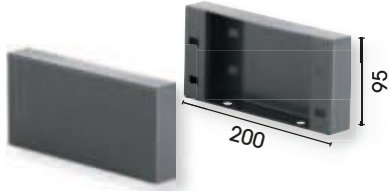

**WEIGHT:**  
0,6Kg

CODE	€/Pz
FG 119/MRT30-9	74,00

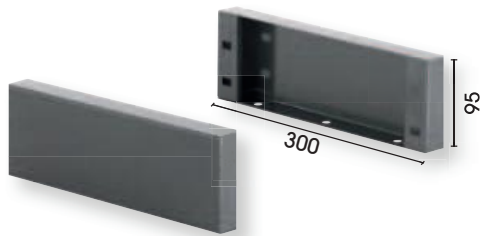

**WEIGHT:**  
0,8Kg

CODE	€/Pz
FG 119/MRT40-9	81,00

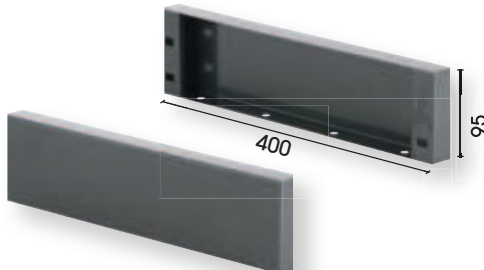

**WEIGHT:**  
1,0Kg



## ACCESSORIES



### Work station

Worktop dimension: 810x250mm

Weight: 22,3Kg

CODE	€/Pz
FG 119/BL	850,00



REMOVABLE WORKTOP



LEVER FOR OPENING AND CLOSING



LOCKING LEVER



### Work station equipped with swivel vice

Worktop dimension: 560x250mm

Weight: 40,5Kg

CODE	€/Pz
FG 119/PM	1.250,00



### Can holder

CODE	€/Pz
FG 100/PL	50,00



### Paper holder

CODE	€/Pz
FG 119/PR	55,00

## Tracks

CODE	L/mm	€/Pz
FG 119/BIN178	178mm	<b>16,00</b>
FG 119/BIN330	330mm	<b>21,00</b>
FG 119/BIN483	483mm	<b>25,00</b>
FG 119/BIN635	635mm	<b>32,00</b>
FG 119/BIN787	787mm	<b>36,00</b>
FG 119/BIN940	940mm	<b>55,00</b>
FG 119/BIN3000	3000mm	<b>92,00</b>



## Double deck bars

CODE	L/mm	CAPACITY	€/Pz
FG 119/BP1000	800 -1000mm	300 daN	<b>140,00</b>
FG 119/BP1300	950 -1300mm	300 daN	<b>160,00</b>
FG 119/BP1750	1250 -1750mm	300 daN	<b>170,00</b>



## Track

CODE	L/mm	€/Pz
FG 119/ROT3000	3000mm	<b>125,00</b>



## Straps

CODE	L/mm-CAPACITY	€/Pz
FG 119/C75-A	0,75m - 1.750 N	<b>17,00</b>
FG 119/C150-A	1,5m - 1.750 N	<b>21,00</b>
FG 119/C100-B	1m - 4.000 N	<b>18,00</b>
FG 119/C200-B	2m - 4.000 N	<b>18,00</b>
FG 119/C100-C	1m - 7.500 N	<b>26,00</b>
FG 119/C200-C	2m - 7.500 N	<b>33,00</b>



## Track

CODE	L/mm	€/Pz
FG 119/ROL3000	3000mm	<b>150,00</b>

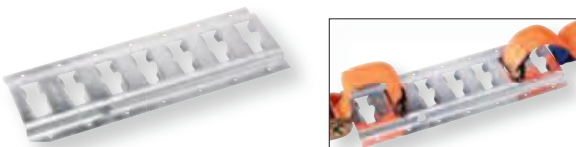

## Straps

CODE	L/mm-CAPACITY	€/Pz
FG 119/C400D	4m - 6.750 N	<b>32,00</b>

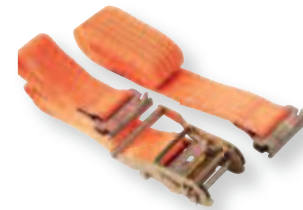

## Poles stop load

CODE	L/mm	CAPACITY	€/Pz
FG 119/PF1760	1160 -1760mm	3.000 N	<b>190,00</b>
FG 119/PF2300	1700 - 2300mm	3.000 N	<b>210,00</b>



## Couple of terminals

CODE	CAPACITY	€/Pz
FG 119/TE1	4000 N	<b>10,00</b>
FG 119/TE2	11.250 N	<b>8,00</b>



## Combined poles

CODE	L/mm	CAPACITY	€/Pz
FG 119/PC1350	1050 -1350mm	3.500 N	<b>160,00</b>
FG 119/PC1600	1300 -1600mm	3.500 N	<b>170,00</b>
FG 119/PC1850	1550 -1850mm	3.500 N	<b>190,00</b>
FG 119/PC2100	1800 - 2100mm	3.500 N	<b>200,00</b>



## Blanket cups with load-securing hook

CODE	€/Pz
FG 119/IP1	<b>6,50</b>
FG 119/IP2	<b>10,00</b>



## End caps for FG 119 / BN tracks

CODE	€/Pz
FG 119/BIN-T	<b>6,00</b>



## FLOORS IN PHENOLIC WOOD, 12MM

The material with which the shelves are produced is 12 mm thick gray birch wood, coated with phenolic film, ideal for use where high resistance to wear is required. The surface has a special non-slip imprint, is resistant to water, atmospheric agents and chemicals. Furthermore, the product is eco-friendly, hygienic and easy to clean.

It is designed to be supplied in an assembly kit a any type of user and do not require special equipment.

They come standard with

- aluminum profiles for rear and side door stops
- load retainer hooks and hole covers

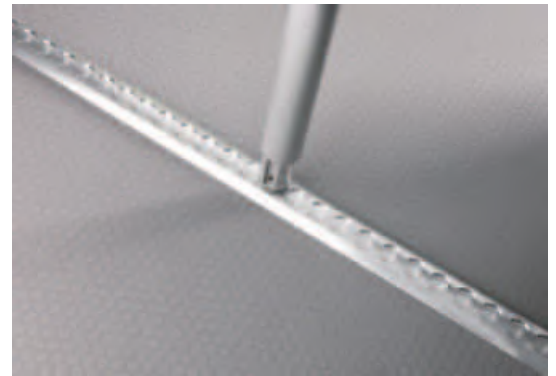
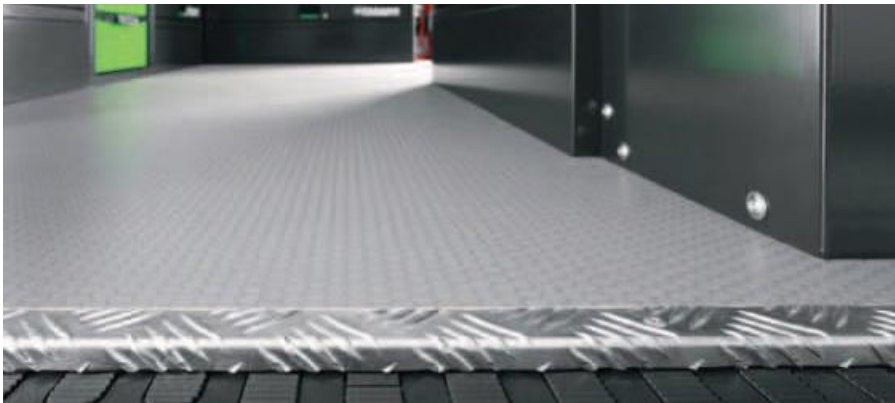

**SCAN THE QR CODE WITH YOUR SMARTPHONE  
AND CHOOSE THE PLATFORM  
ACCORDING TO THE MODEL OF YOUR VAN**



## POLYPROPYLENE PANELS

### ALVEOLAR PPL PANELS

The internal lining is indicated to avoid damage to the bodywork caused by the impact of the goods and is easy to install.

The material used is PPL (Polypropylene) alveolar gray in color and 4 mm thick. The panels are waterproof, scratch and mold resistant. Easy to clean and resistant to high temperatures, water and oil.



**SCAN THE QR CODE WITH YOUR SMARTPHONE  
AND CHOOSE THE PANELS  
ACCORDING TO THE MODEL OF YOUR VAN**





## Rubber modules (Eva Foam)

Organize your tools with our rubber modules, to be assembled and modular at your choice, based on the size of the drawer.

**Order and functionality for your work!**

The modular system allows you to customize the van set-up according to your needs to make your work more functional and faster.

### CREATE YOUR DRAWER

#### Drawer l/mm 49

1/3
1/3

1/3	
1/6	1/6

2/3
-----

1/2
1/6A

#### Drawer l/mm 73

1/3	1/6
1/3	1/6

1/3	1/6	
1/6	1/6	1/6

2/3	1/6
	1/6

1/2	1/6
1/6A	1/6

#### Drawer l/mm 98

1/3	1/3
1/3	1/3

2/3	2/3
-----	-----

2/3	1/3
	1/3

1/2	1/6	1/6
1/6A	1/6	1/6









17

**PROFESSIONAL EQUIPMENT**



**FASANO**  
TOOLS



## SHOCK ABSORBER REMOVAL TOOL

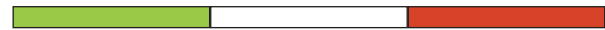
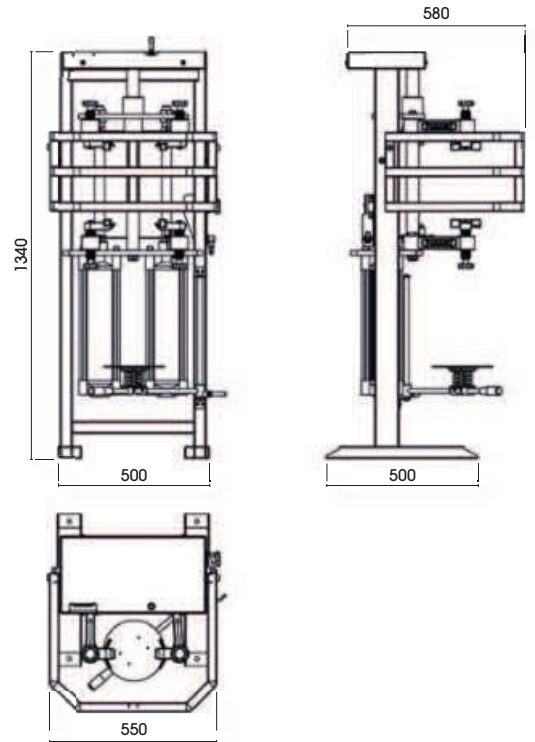

MADE IN ITALY



### Shock absorber removal equipment - 1 Piston

CODE	CAPACITY	€/Pz
FG 750/1P	1.200 Kg	2.600,00

Power: 1.2 ton (10 bar) - 0.9 ton (8 bar)  
Spring compression stroke: 300mm



### Shock absorber removal equipment - 2 Pistons

CODE	CAPACITY	€/Pz
FG 750/2P	2.400 Kg	3.300,00

Power: 2.4 ton (10 bar) - 1.9 ton (8 bar)  
Spring compression stroke: 300mm



### Shock absorber removal equipment with 1 Piston and digital display

CODE	CAPACITY	€/Pz
FG 752/1P	1.200 Kg	3.400,00

The digital display shows the pressure applied during use phase



### Shock absorber removal equipment with 2 Pistons and digital display

CODE	CAPACITY	€/Pz
FG 752/2P	2.400 Kg	4.100,00

The digital display shows the pressure applied during use phase





**Folding engine stand**

CODE	CAPACITY	€/Pz
FG 745/CMR	560 Kg	950,00

- Resealable version
- Possibility of 360 ° rotation
- Steel wheels for enhanced durability and capacity

360° crank rotation system



**Engine stand**

CODE	CAPACITY	€/Pz
FG 745/CMF	560 Kg	460,00

- Possibility of 360 ° rotation
- Steel wheels for enhanced durability and capacity

360° rotation system



**Heavy duty engine crane**

CODE	CAPACITY	H-Min/Max	€/Pz
FG 738/1T	1 Ton	94-2.300mm	1.100,00



- Resealable version
- Steel wheels for enhanced durability and capacity

1470

800



Lifting by using the handle



Metal structure



4 nylon wheels

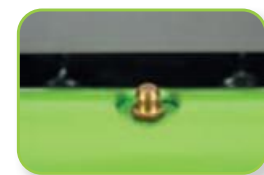

air purge valve

# HYDRAULIC JACK

## 3 New Items

### SIZE

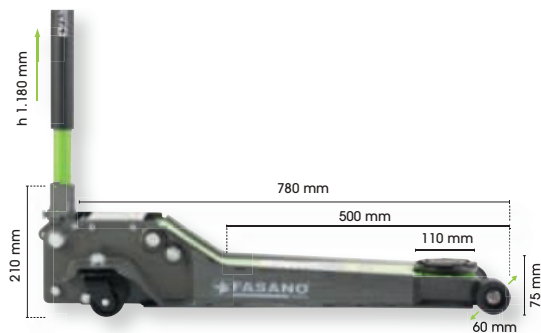

### Long lowered Hydraulic jack 2T

#### TECHNICAL FEATURES:

- Lowered ideal for working also on vehicles with a reduced height from the ground
- Long design
- Tough metal structure
- Controlled descent speed
- Handle covered with rubber
- 4 nylon wheels
- Air purge valve
- Minimum height 75 mm - maximum height 610 mm
- Weight 43.5kg

CODE	€/Pz
FG 719/2T	740,00



NEW



## Short Hydraulic jack 2.5T

### TECHNICAL FEATURES:

- Tough metal structure
- Controlled descent speed
- Handle lowered with rubber
- 4 nylon wheels
- Air purge valve
- Minimum height 75 mm - maximum height 510 mm
- Weight 30kg

CODE	€/Pz
FG 718/2.5T	470,00



**NEW**



### SIZE

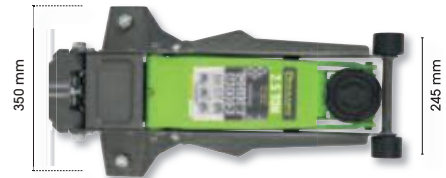
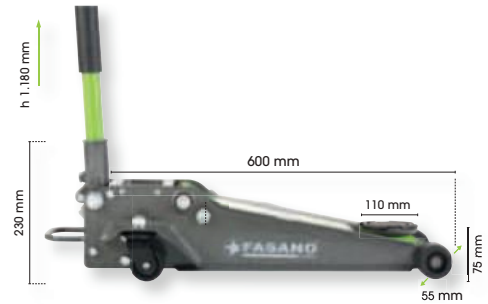

## Short lowered Hydraulic jack 3.5T

### TECHNICAL FEATURES:

- Lowered ideal for working also on vehicles with a reduced height from the ground
- High lifting capacity, it can be used also with off-road vehicles and small vans
- Tough metal structure
- Controlled descent speed
- Handle with shockproof rubber
- 4 nylon wheels
- Air purge valve
- Minimum height 95 mm - maximum height 540 mm
- Weight 39kg

CODE	€/Pz
FG 718/3.5T	560,00



**NEW**



### SIZE

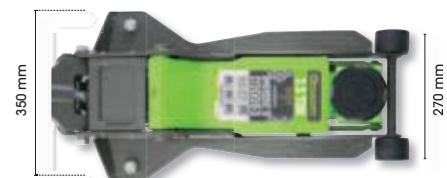
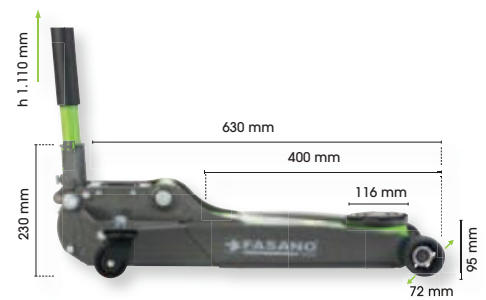

# 17 PROFESSIONAL EQUIPMENT

## Hydraulic jack 5 Ton - long model for heavy vehicles

CODE	€/Pz
FG 722/5T	1.420,00

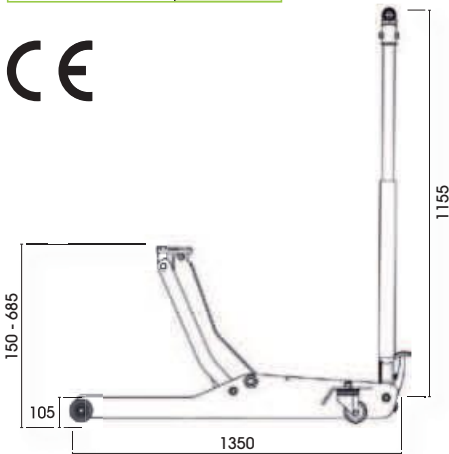

Lifting system with auxiliary pedal



Steel wheels mounted on ball bearings



## Jack stands

CODE	CAPACITY	H-Min/Max	€/Pz
FG 725/3T	3 Ton	285-425mm	95,00
FG 725/6T	6 Ton	390-605mm	160,00
FG 725/12T	12 Ton	495-720mm	280,00



## Hydraulic bottle jacks

CODE	CAPACITY	H-Min/Max	€/Pz
FG 735/4T	4 Ton	193-373mm	85,00
FG 735/6T	6 Ton	210-416mm	98,00
FG 735/10T	10 Ton	230-460mm	140,00
FG 735/16T	16 Ton	230-440mm	160,00
FG 735/20T	20 Ton	242-452mm	200,00



## Wheel lifter

CODE	CAPACITY	€/Pz
FG 750/A	680 Kg	420,00

- Pedal lifting system
- Equipped with 4 swivel wheels

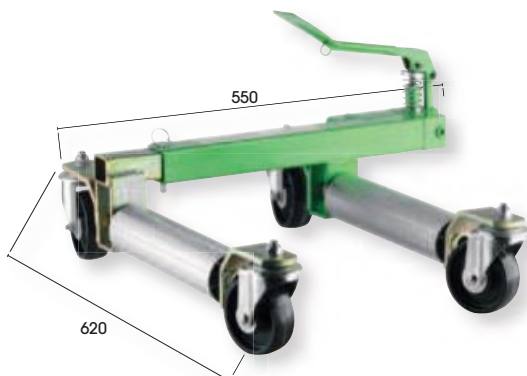

## Engine brackets

CODE	CAPACITY	€/Pz
FG 748/0.5T	500 Kg	250,00

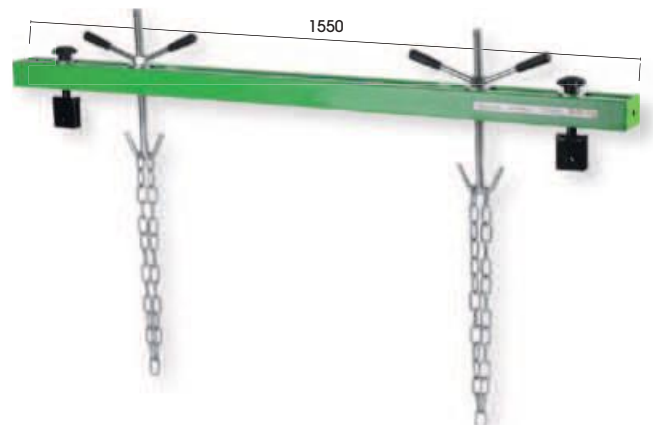

### Lower engine bracket

CODE	L/mm	€/Pz
FG 213/SM	1.050	750,00

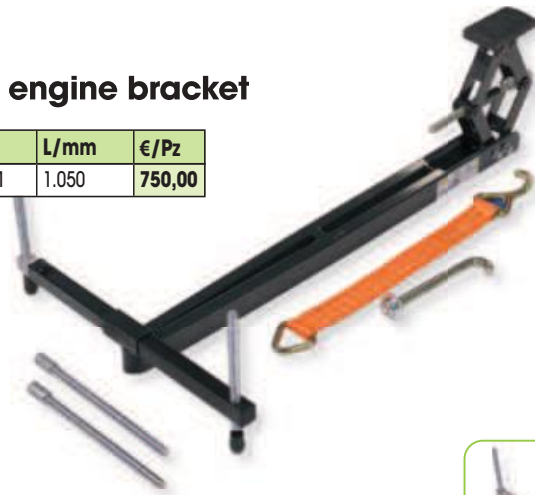

### Lower engine bracket

CODE	L/mm	€/Pz
FG 213/SM1	1.100	590,00



### Transmission jack - 0.5 Ton

CODE	CAPACITY	H-Min/Max	€/Pz
FG 740/0.5T	500 Kg	934-1.864mm	600,00

- Pedal lifting system
- Equipped with 4 swivel wheels



### Lever for pulling arm and shock absorbers

CODE	L/mm	€/Pz
FG 213/LT	750	310,00



### Transmission support

CODE	€/Pz
FG 213/SU	630,00



Equipped with adaptor for under bridge jack Ø 25-30-35-45mm

Suitable for passenger cars and commercial vehicles





## Seat with swivelling wheels and accessories

CODE	€/Pz
FG 710/C	150,00



2 drawers equipped with telescopic guides



Can holder accessory in shockproof plastic



Padded seat and PVC coated

## Seat with swivelling wheels and accessories

CODE	€/Pz
FG 710/D	245,00



Large fitted drawer on telescopic guides



Equipped with accessories for small parts and can holders easily removable

## Under car bed in shockproof plastic

CODE	€/Pz
FG 710/A	95,00

Dimension: 1.020x450x90mm



6 Swivelling wheels 76mm



Padded headrest with PVC coating

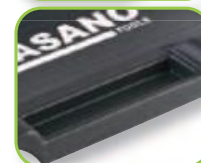

2 side compartments small parts holder

**KG**  
136  
LOAD CAPACITY

## Foldable under car bed

CODE	€/Pz
FG 710/B	120,00

Dimensions: 910x415x120mm  
540x415x150mm



Foldable e transportable



6 Swivelling wheels 65mm



Steel structure and padded body covered in PVC

**KG**  
136  
LOAD CAPACITY



## THE WORLD OF FASANO TOOLS IS CONTINUOUSLY EVOLVING

We are always looking for new products, increasingly performing and innovative, to facilitate the daily work of professionals in the sector.

**STAY UP TO DATE**

**FOLLOW US ON SOCIAL CHANNELS**



**SUBSCRIBE TO THE NEWSLETTER**

**WWW.FASANOTOOLS.COM**

CODE	PAGE	€/Pz
FG BEST 108	59	270,00
FG BEST 171	59	400,00
FG/EBV	303	40,00
FG/XTIP1	303	140,00
FG/XTV	303	120,00
FG/XT V2	303	120,00
FG 20/A1	292	62,00
FG 20/A2	293	56,00
FG 20/AD4	293	5,00
FG 20/AD4.75	293	5,00
FG 20/AD6	293	5,00
FG 20/AD8	293	5,00
FG 20/AD10	293	5,00
FG 20/AD12	293	5,00
FG 20/AD14	293	5,00
FG 21/CD	293	31,00
FG 21/CR	293	38,00
FG 21/CS	293	55,00
FG 21/S10	293	145,00
FG 22/2.5x60	76	5,10
FG 22/2.5x75	76	5,10
FG 22/2.5x200	78	7,40
FG 22/2.5x300	78	8,90
FG 22/3x75	76	5,10
FG 22/3x100	76	5,30
FG 22/3.5x100	76	5,50
FG 22/3.5x125	76	5,60
FG 22/4x100	76	5,80
FG 22/4x125	76	6,00
FG 22/4x150	76	6,10
FG 22/4x400	78	11,20
FG 22/5.5x100	76	6,40
FG 22/5.5x150	76	7,40
FG 22/5.5x200	76	7,40
FG 22/5x400	78	13,00
FG 22/6.5x100	76	7,90
FG 22/6.5x150	76	8,20
FG 22/6.5x400	78	16,20
FG 22/8x150	76	10,70
FG 22/8x200	76	12,30
FG 22/10x200	76	14,50
FG 22/12x250	76	15,20
FG 22/4x30	76	6,20
FG 22/6.5x30	76	6,40
FG 22SL/S5	76	35,00
FG 22SL/S9	76	75,00
FG 22SL/S12	76	102,00
FG 22/5.5x125H	78	6,50
FG 22/6.5x150H	78	8,50
FG 22/8x175H	78	10,50
FG 22/10x200H	78	13,00
FG 22/12x200H	78	14,50
FG 22/CF250	105	7,50
FG 22/CF24	105	9,00
FG 22/FL5	80	21,00
FG 22/FL5.5	80	21,00
FG 22/FL6	80	21,00
FG 22/FL7	80	21,00
FG 22/FL8	80	21,00
FG 22/FL10	80	21,00
FG 22FL/S6	80	127,00
FG 22/FX5	80	12,00
FG 22/FX5.5	80	12,00
FG 22/FX6	80	12,00
FG 22/FX7	80	13,50
FG 22/FX8	80	13,50
FG 22/FX9	80	13,50
FG 22/FX10	80	14,50
FG 22/FX11	80	14,50
FG 22/FX12	80	14,50
FG 22/FX13	80	16,00

CODE	PAGE	€/Pz
FG 22FX/S6	80	85,50
FG 22FX/S9B	80	125,50
FG 22FX/S10	80	140,00
FG 22/H2	78	6,00
FG 22/H2.5	78	6,10
FG 22/H3	78	6,20
FG 22/H4	78	7,00
FG 22/H5	78	8,00
FG 22/H6	78	9,00
FG 22/H8	78	11,50
FG 22H/S7	78	55,00
FG 22/OF4	78	4,80
FG 22/OF5	78	5,30
FG 22/OF8	78	7,50
FG 22/PH12	78	5,40
FG 22/PH34	78	10,20
FG 22/PH0x60	76	5,00
FG 22/PH0x300	78	8,00
FG 22/PH1x30	76	6,00
FG 22/PH2x30	76	6,30
FG 22/PH1x80	76	6,40
FG 22/PH1x150	76	6,50
FG 22/PH1x200	76	7,60
FG 22/PH1x400	78	12,00
FG 22/PH2x100	76	8,00
FG 22/PH2x150	76	8,50
FG 22/PH2x200	76	9,00
FG 22/PH2x400	78	14,50
FG 22/PH3x150	76	10,80
FG 22/PH4x200	76	14,00
FG 22PH/S4	76	34,00
FG 22PH/S6	76	54,00
FG 22PH/S8	76	68,00
FG 22/PH2x100H	78	9,50
FG 22/PH3x150H	78	11,00
FG 22/PH4x200H	78	14,50
FG 22/PZ0x60	77	5,30
FG 22/PZ1x30	77	6,00
FG 22/PZ2x30	77	6,10
FG 22/PZ1x80	77	6,40
FG 22/PZ2x100	77	7,60
FG 22/PZ3x150	77	11,00
FG 22/PZ4x200	77	13,60
FG 22PZ/S4	77	33,00
FG 22PZ/S5	77	47,00
FG 22PZ/S7	77	60,00
FG 22/S6	77	36,00
FG 22/S7	77	50,00
FG 22/S8	77	48,00
FG 22/S8B	77	52,00
FG 22/S8H	78	90,00
FG 22/S10	77	65,00
FG 22/S12	77	90,00
FG 22/TX6	79	6,80
FG 22/TX7	79	6,80
FG 22/TX8	79	8,00
FG 22/TX9	79	8,00
FG 22/TX10	79	9,30
FG 22/TX15	79	9,30
FG 22/TX20	79	9,30
FG 22/TX25	79	10,50
FG 22/TX27	79	10,50
FG 22/TX30	79	10,50
FG 22/TX40	79	12,00
FG 22/TX45	79	13,50
FG 22TX/S6	79	65,00
FG 22TX/S8	79	86,00
FG 22TX/S12	79	115,00
FG 22/RTX6	79	8,60
FG 22/RTX7	79	8,60
FG 22/RTX8	79	8,60

CODE	PAGE	€/Pz
FG 22/RTX9	79	8,60
FG 22/RTX10	79	9,40
FG 22/RTX15	79	9,70
FG 22/RTX20	79	10,00
FG 22/RTX25	79	10,30
FG 22/RTX27	79	10,60
FG 22/RTX30	79	11,50
FG 22/RTX40	79	11,90
FG 22/RTX45	79	13,50
FG 22RTX/S6	79	66,00
FG 22RTX/S8	79	90,00
FG 22RTX/S12	79	125,00
FG 22E/2.5x75	104	8,00
FG 22E/3x100	104	8,20
FG 22E/4x100	104	9,00
FG 22E/5.5x125	104	10,50
FG 22E/6.5x150	104	11,00
FG 22E/8x175	104	12,00
FG 22E/SL6	104	62,00
FG 22E/PH0x60	104	8,00
FG 22E/PH1x80	104	9,00
FG 22E/PH2x100	104	10,00
FG 22E/PH3x150	104	11,00
FG 22E/SH4	104	46,00
FG 22E/PZ0x60	104	8,00
FG 22E/PZ1x80	104	8,80
FG 22E/PZ2x100	104	9,50
FG 22E/PZ3x150	104	11,00
FG 22E/SZ4	104	46,00
FG 22E/S6	104	58,00
FG 22E/SZ6	104	58,00
FG 22XL/TX6	80	11,10
FG 22XL/TX7	80	11,10
FG 22XL/TX8	80	11,10
FG 22XL/TX9	80	11,10
FG 22XL/TX10	80	13,50
FG 22XL/TX15	80	13,50
FG 22XL/TX20	80	13,50
FG 22XL/TX25	80	16,90
FG 22XL/TX27	80	16,90
FG 22XL/TX30	80	16,90
FG 22XL/TX40	80	16,90
FG 22TX/LS8	80	122,00
FG 22TX/LS11	80	155,00
FG 22XL/S6	78	67,00
FG 22XL/S8	78	92,00
FG 23/I	89	42,00
FG 23/S28	89	150,00
FG 24/CU1	293	40,00
FG 24/CU2	293	40,00
FG 30/GA1	292	27,00
FG 30/GA1.5	292	38,00
FG 30/GA2	292	45,00
FG 30/GA2B	292	52,00
FG 30/GA2.5	292	75,00
FG 30/GA3	292	112,00
FG 32/GP1	292	32,00
FG 32/GP1.5	292	45,00
FG 32/GP2	292	70,00
FG 32/GS1	292	32,00
FG 32/GS1.5	292	45,00
FG 32/GS2	292	70,00
FG 33/GA2	292	68,00
FG 33/GA2.5	292	96,00
FG 33/GA3	292	145,00
FG 33/GA5	292	290,00
FG 34/GL1	292	20,00
FG 34/GL1.5	292	25,00
FG 35/1	293	19,00
FG 35/B1	293	19,50
FG 35/B2	293	20,00

CODE	PAGE	€/Pz
FG 35/B3	293	25,00
FG 35/B4	293	31,00
FG 35/B5	293	40,00
FG 35/E250	100	98,00
FG 36/1	24	27,00
FG 36/2	24	30,50
FG 36/3	24	42,00
FG 36/4	24	55,00
FG 36/5	24	74,00
FG 37/1	25	27,50
FG 37/2	25	33,50
FG 37/3	25	43,00
FG 37/4	25	59,00
FG 37/5	25	75,50
FG 37/1R	25	5,50
FG 37/2R	25	6,50
FG 37/3R	25	9,00
FG 37/4R	25	12,00
FG 37/5R	25	14,50
FG 38/1	24	8,60
FG 38/2	24	10,50
FG 38/3	24	10,50
FG 38/4	24	12,50
FG 38/5	24	12,50
FG 38/6	24	15,80
FG 38/7	24	15,70
FG 38/8	24	18,90
FG 38/9	24	18,90
FG 38/10	24	25,00
FG 38/11	24	25,00
FG 38/12	24	36,80
FG 38/13	24	42,00
FG 38/14	24	58,00
FG 38/15	24	58,00
FG 38/16	24	76,00
FG 43/MT3	154	7,00
FG 43/MT5	154	9,00
FG 44/MT3	154	11,00
FG 44/MT5	154	18,00
FG 44/MT8	154	24,00
FG 44/MT10	154	29,00
FG 45/MT10	155	11,00
FG 45/MT20	155	12,00
FG 46/FR2	155	9,00
FG 47/P1	277	18,50
FG 47/P2	277	18,50
FG 47/P3	277	18,50
FG 47/S3	277	58,00
FG 47/S4	277	21,50
FG 48/B	130	21,00
FG 48/IS	106	24,00
FG 48/K12	130	8,00
FG 48/KL10	130	6,00
FG 48/L	130	9,00
FG 48/LG	130	9,00
FG 48/L9	130	7,00
FG 48/KL9	130	6,00
FG 48/P	130	10,00
FG 48/PL	130	6,50
FG 49	130	16,00
FG 49/TC	130	39,50
FG 49/TCX	130	46,00
FG 49/E	106	40,00
FG 49/CL	131	27,50
FG 49/CR	131	27,50
FG 49/CS	131	27,50
FG 49/HE200	131	22,00
FG 49/HE250	131	25,00
FG 49/HE300	131	32,00
FG 49/HE350	131	40,00
FG 49/L	130	17,00

CODE	PAGE	€/Pz	CODE	PAGE	€/Pz	CODE	PAGE	€/Pz	CODE	PAGE	€/Pz
FG 49/MU	131	26,50	FG 59SR/S3B	92	92,00	FG 68/AT16	108	65,00	FG 72/M8X1	134	11,00
FG 50/ME	132	38,00	FG 59/XT160	90	22,00	FG 68/AG	108	65,00	FG 72/M9X1	134	13,00
FG 50/MI	132	8,50	FG 59/XT180	90	27,00	FG 68/BNC	108	94,00	FG 72/M10X0,75	134	13,00
FG 50/MIL	132	15,00	FG 59/XT200	90	31,00	FG 68/NI	108	73,00	FG 72/M10x1	134	13,00
FG 50/LBM	132	27,00	FG 59XT/S3	91	85,00	FG 68/RJ	108	73,00	FG 72/M10X1,25	134	13,00
FG 50/MN	132	12,00	FG 59XT/S3B	91	95,00	FG 68/UN	108	86,00	FG 72/M11X1	134	18,50
FG 50/MN-B	132	6,50	FG 60PV/160	93	22,50	FG 68/MAT4	108	42,00	FG 72/M12X1	134	18,50
FG 50/MS	132	7,50	FG 60PV/200	93	26,50	FG 68/MAT16	108	42,00	FG 72/M12X1,25	134	18,50
FG 50/MSL	132	10,50	FG 60SR/160	92	26,00	FG 68/MAG	108	42,00	FG 72/M12X1,5	134	18,50
FG 50/PE	132	17,50	FG 60SR/200	92	31,50	FG 68/MAN	108	42,00	FG 72/M13X1,5	134	26,50
FG 50/SE	132	24,50	FG 60/XT160	90	30,00	FG 68/MAS	108	42,00	FG 72/M14X1	134	26,50
FG 51/140	95	22,00	FG 60/XT200	90	34,00	FG 68U/S439	108	290,00	FG 72/M14X1,25	134	26,50
FG 51/180	95	22,50	FG 61/IS200	106	39,00	FG 68/S1	105	13,50	FG 72/M14X1,5	134	26,50
FG 51/230	95	31,50	FG 61PV/160	93	21,50	FG 68/SP	105	34,00	FG 72/M15X1,5	134	32,00
FG 51/310	95	44,50	FG 61PV/200	93	23,50	FG 68/SP1	105	21,00	FG 72/M16X1	134	32,00
FG 52/140	95	23,00	FG 61SR/200	92	27,00	FG 68/SP2	105	14,50	FG 72/M16x1,5	134	32,00
FG 52/180	95	25,00	FG 61/XT160	90	26,00	FG 69/CC170	96	27,00	FG 72/M18X1,5	134	40,00
FG 52/230	95	30,50	FG 61/XT200	90	31,00	FG 69/CC280	96	36,00	FG 72/M18X2	134	40,00
FG 52/310	95	44,50	FG 62PV/160	93	21,00	FG 69/CC460	96	51,00	FG 72/M20X1,25	134	47,00
FG 53/140	95	22,00	FG 62SR/160	92	24,00	FG 69/CH130	97	41,00	FG 72/M20X1,5	134	47,00
FG 53/180	95	22,50	FG 62/XT160	91	28,00	FG 69/CJ180	96	22,50	FG 72/M20X2	134	47,00
FG 53/230	95	31,50	FG 63/HIS180	106	42,00	FG 69/CJ250	96	25,00	FG 72/M22X1,5	134	64,00
FG 53/310	95	44,50	FG 63/HIS200	106	43,00	FG 69/CP170	97	33,00	FG 72/M24X1	134	64,00
FG 54/140	95	23,00	FG 63/IS160	106	38,50	FG 69/CP280	97	39,50	FG 72/M24X1,5	134	75,00
FG 54/180	95	25,00	FG 63/IS160	106	38,50	FG 69/CS200	97	31,00	FG 72/M24X2	134	75,00
FG 54/230	95	30,50	FG 63/H160	91	32,00	FG 69/CW225	97	32,50	FG 73/M3x0,5	135	9,00
FG 54/310	95	44,50	FG 63/H180	91	34,00	FG 69/LN170	96	23,00	FG 73/M4x0,7	135	9,00
FG 51/S4	95	95,00	FG 63/H200	91	38,00	FG 69/LN230	96	27,00	FG 73/M5x0,8	135	9,00
FG 51/S4B	95	100,00	FG 63/HL180	91	46,00	FG 69/PC	141	85,00	FG 73/M6x1	135	9,00
FG 55/SP	95	45,00	FG 63PV/140	93	20,50	FG 69/PP215	97	36,00	FG 73/M7X1	135	12,00
FG 55/140	95	32,00	FG 63PV/160	93	22,50	FG 70/CJ140	96	31,00	FG 73/M8X1,25	135	12,50
FG 55/180	95	33,00	FG 63PV/H180	93	28,00	FG 70/CJ180	96	33,00	FG 73/M10X1,5	135	19,00
FG 55/S4	95	130,00	FG 63PV/H200	93	29,00	FG 70/CJ250	96	34,50	FG 73/M12X1,75	135	21,50
FG 56/140	95	32,00	FG 63SR/160	92	26,00	FG 70/CJ300	96	52,00	FG 73/M14X2	135	21,50
FG 56/180	95	33,00	FG 63SR/H180	92	30,00	FG 70/CJ165	96	37,00	FG 73/M16X2	135	33,00
FG 55/S4B	95	135,00	FG 63SR/H200	92	33,00	FG 70/LN165	96	37,00	FG 73/M18X2,5	135	33,00
FG 56/0	94	28,00	FG 63/XT140	91	28,00	FG 70/LN240	96	39,50	FG 73/M20X2,5	135	33,00
FG 56/45	94	28,00	FG 63/XT160	91	30,00	FG 70/CC175	96	39,00	FG 73/M22X2,5	135	50,00
FG 56/90	94	28,00	FG 64PV/160	93	26,00	FG 70/CC280	96	51,00	FG 73/M24X3	135	50,00
FG 56/S3	94	85,00	FG 64PV/200	93	32,00	FG 70/CC460	96	106,00	FG 74/GF16x5	135	6,60
FG 57/0	94	38,00	FG 64SR/220	92	29,15	FG 70/CP175	97	58,00	FG 74/GF20x5	135	6,60
FG 57/45	94	38,00	FG 64SR/280	92	35,51	FG 70/CP280	97	62,00	FG 74/GF20x7	135	6,60
FG 57/90	94	38,00	FG 64/XT160	91	35,00	FG 70/S110	136	335,00	FG 74/GF25x9	135	7,50
FG 57/S3	94	116,00	FG 64/XT200	91	42,00	FG 70/S65	136	560,00	FG 74/GF30x11	135	10,00
FG 57/140	95	32,00	FG 65PV/220	93	24,00	FG 71/M3x0,5	134	12,50	FG 74/GF38x14	135	18,50
FG 57/180	95	33,00	FG 65PV/250	93	26,00	FG 71/M4x0,7	134	12,50	FG 74/GF45x18	135	26,00
FG 58/140	95	32,00	FG 65PV/280	93	28,00	FG 71/M5x0,8	134	14,00	FG 74/GF55x22	135	26,00
FG 58/180	95	33,00	FG 65/SR250	195	32,50	FG 71/M6X1	134	14,00	FG 74/GF65x25	135	34,00
FG 58/A240	94	42,00	FG 65/XT160	91	27,00	FG 71/M7X1	134	17,00	FG 74/M6x0,75	135	9,00
FG 58/B180	94	29,00	FG 66/TF220	94	102,00	FG 71/M8X1,25	134	17,00	FG 74/M7X0,5	135	12,00
FG 58/B240	94	33,50	FG 68/CC	106	168,00	FG 71/M10x1,5	134	20,00	FG 74/M8X0,75	135	12,00
FG 58/B300	94	47,00	FG 68/CR	106	205,00	FG 71/M12X1,75	134	28,00	FG 74/M8X1	135	12,00
FG 58/400	94	52,00	FG 68/CS1	105	16,00	FG 71/M14X2	134	39,00	FG 74/M9X0,75	135	12,00
FG 58/IS250	106	54,00	FG 68/CS2	105	18,00	FG 71/M16X2	134	39,00	FG 74/M9X1	135	12,00
FG 59/IS180	106	37,50	FG 68/CS6	105	25,50	FG 71/M18x2,5	134	60,00	FG 74/M9X1,25	135	12,00
FG 59/IS200	106	40,00	FG 68/CS1-R	105	6,10	FG 71/M20X2,5	134	70,00	FG 74/M10X0,5	135	18,50
FG 59IS/S3	106	118,50	FG 68/CS2-R	105	6,10	FG 71/M22X2,5	134	90,00	FG 74/M10X0,75	135	18,50
FG 59/HL160	90	26,00	FG 68/CS6-R	105	8,00	FG 71/M24X3	134	110,00	FG 74/M10X1	135	18,50
FG 59/HL180	90	29,00	FG 68IS/160	106	38,00	FG 72/GMC1	134	17,50	FG 74/M10X1,25	135	18,50
FG 59/HL200	90	34,00	FG 68SR/160	92	30,00	FG 72/GMC2	134	22,00	FG 74/M11X0,5	135	18,50
FG 59/HL225	90	36,00	FG 68/TC230	106	83,00	FG 72/GMC3	134	28,00	FG 74/M11X0,75	135	18,50
FG 59PV/160	93	19,50	FG 67/350R	131	21,50	FG 72/GMC4	134	34,00	FG 74/M11X1	135	18,50
FG 59PV/180	93	21,00	FG 67/450R	131	26,00	FG 72/GMM0	134	7,00	FG 74/M12X0,75	135	31,00
FG 59PV/200	93	24,00	FG 67/600R	131	34,50	FG 72/GMM1	134	8,00	FG 74/M12X1	135	31,00
FG 59PV/S3	93	68,00	FG 67/750R	131	48,50	FG 72/GMM1,5	134	8,00	FG 74/M12x1,25	135	31,00
FG 59PV/S3B	93	75,00	FG 67/900R	131	64,50	FG 72/GMM2	134	15,00	FG 74/M12x1,5	135	31,00
FG 59SR/160	92	20,50	FG 67/350	131	48,00	FG 72/GMM3	134	24,50	FG 74/M14x1	135	31,00
FG 59SR/180	92	25,00	FG 67/450	131	61,00	FG 72/GMM4	134	31,00	FG 74/M14x1,25	135	31,00
FG 59SR/180	92	28,00	FG 67/600	131	82,50	FG 72/GMM5	134	40,00	FG 74/M14x1,5	135	31,00
FG 59SR/200	92	28,00	FG 67/750	131	107,00	FG 72/M6x0,75	134	9,00	FG 74/M15x1	135	31,00
FG 59SR/S3	92	82,00	FG 67/900	131	135,00	FG 72/M7X0,75	134	11,00	FG 74/M16x1	135	46,00
			FG 68/AT6	108	65,00	FG 72/M8X0,75	134	11,00			

CODE	PAGE	€/Pz	CODE	PAGE	€/Pz	CODE	PAGE	€/Pz	CODE	PAGE	€/Pz
FG 74/M16x1,5	135	46,00	FG 75/HSS6	140	2,80	FG 77/PVC5	141	56,00	FG 79/SR1R	293	6,00
FG 74/M18x1,5	135	46,00	FG 75/HSS6,25	140	3,80	FG 77/TT	131	9,60	FG 80/BL140	110	31,00
FG 74/M20x1,25	135	46,00	FG 75/HSS6,5	140	3,50	FG 78/AL12	138	35,00	FG 80/BLP140	110	31,00
FG 74/M20x1,5	135	46,00	FG 75/HSS6,75	140	4,20	FG 78/AL14	138	18,00	FG 80/BP125	110	31,00
FG 74/M20x2	135	46,00	FG 75/HSS7	140	4,60	FG 78/HSS14	138	8,40	FG 80/8AR	133	15,00
FG 74/M21x1,5	135	46,00	FG 75/HSS7,5	140	4,20	FG 78/HSS16	138	8,40	FG 80/8AM	133	15,00
FG 74/M22x1,5	135	73,00	FG 75/HSS8	140	5,10	FG 78/HSS17	138	8,40	FG 80/8AP	133	16,00
FG 74/M24x1	135	73,00	FG 75/HSS8,5	140	6,20	FG 78/HSS19	138	8,40	FG 80/8AT	133	15,00
FG 74/M24x1,5	135	73,00	FG 75/HSS9	140	6,50	FG 78/HSS20	138	8,40	FG 80/8AQ	133	17,00
FG 74/M24x2	135	73,00	FG 75/HSS9,5	140	6,70	FG 78/HSS21	138	8,60	FG 80/S5B	133	78,00
FG 74/PM3X0.5	135	18,50	FG 75/HSS10	140	7,50	FG 78/HSS22	138	8,60	FG 80HSS/1	137	22,00
FG 74/PM4x0,7	135	18,50	FG 75/HSS10,5	140	9,00	FG 78/HSS24	138	8,60	FG 80HSS/2	137	40,00
FG 74/PM5x0,8	135	18,50	FG 75/HSS11	140	11,00	FG 78/HSS25	138	8,70	FG 80HSS/3	137	75,00
FG 74/PM6x1	135	18,50	FG 75/HSS11,5	140	11,50	FG 78/HSS27	138	8,80	FG 80HSS/S3	137	145,00
FG 74/PM8x1,25	135	20,50	FG 75/HSS12	140	12,50	FG 78/HSS28	138	8,80	FG 80MD/AR3	137	13,00
FG 74/PM10x1,5	135	21,00	FG 75/HSS12,5	140	13,50	FG 78/HSS29	138	8,80	FG 80MD/AR6	137	39,00
FG 74PM/S7	135	118,00	FG 75/HSS13	140	14,50	FG 78/HSS30	138	9,00	FG 80MD/AR12.7	137	68,00
FG 75/CO0,5	141	4,20	FG 75/HSS14	140	22,00	FG 78/HSS32	138	9,60	FG 80MD/CS3	137	13,00
FG 75/CO1	141	2,70	FG 75/HSS15	140	27,00	FG 78/HSS33	138	9,90	FG 80MD/CS6	137	39,00
FG 75/CO1,5	141	2,70	FG 75/HSS16	140	31,00	FG 78/HSS35	138	10,50	FG 80MD/CS12.7	137	68,00
FG 75/CO2	141	2,70	FG 75/HSS17	140	37,00	FG 78/HSS37	138	11,00	FG 80MD/EC3	137	13,00
FG 75/CO2,5	141	2,80	FG 75/HSS18	140	44,00	FG 78/HSS38	138	11,00	FG 80MD/EC6	137	39,00
FG 75/CO3	141	2,80	FG 75/HSS19	140	47,00	FG 78/HSS40	138	11,20	FG 80MD/EC12.7	137	68,00
FG 75/CO3,5	141	3,60	FG 75/HSS20	140	54,00	FG 78/HSS41	138	11,50	FG 80MD/ER3	137	13,00
FG 75/CO4	141	4,20	FG 75HSS/S25	140	135,00	FG 78/HSS43	138	11,50	FG 80MD/ER6	137	39,00
FG 75/CO4,5	141	4,90	FG 75/S25	140	75,00	FG 78/HSS44	138	11,70	FG 80MD/ER12.7	137	68,00
FG 75/CO5	141	4,90	FG 75/S170	140	250,00	FG 78/HSS46	138	11,70	FG 80MD/ET3	137	13,00
FG 75/CO5,5	141	6,70	FG 75/TIN0,5	140	1,70	FG 78/HSS48	138	11,70	FG 80MD/ET6	137	39,00
FG 75/CO6	141	7,20	FG 75/TIN1	140	1,70	FG 78/HSS50	138	12,40	FG 80MD/ET12.7	137	68,00
FG 75/CO6,5	141	8,50	FG 75/TIN1,5	140	1,40	FG 78/HSS51	138	12,40	FG 80MD/SV3	137	13,00
FG 75/CO7	141	10,30	FG 75/TIN2	140	1,60	FG 78/HSS52	138	12,40	FG 80MD/SV6	137	39,00
FG 75/CO7,5	141	12,30	FG 75/TIN2,5	140	1,70	FG 78/HSS54	138	13,50	FG 80MD/SV12.7	137	68,00
FG 75/CO8	141	13,30	FG 75/TIN3	140	2,10	FG 78/HSS57	138	13,90	FG 81/BMC140	111	31,00
FG 75/CO8,5	141	13,50	FG 75/TIN3,5	140	2,30	FG 78/HSS59	138	13,90	FG 81/BML140	111	31,00
FG 75/CO9	141	17,50	FG 75/TIN4	140	2,40	FG 78/HSS60	138	14,50	FG 81/BMP140	111	31,00
FG 75/CO9,5	141	18,50	FG 75/TIN4,5	140	2,80	FG 78/HSS64	138	14,60	FG 81/BMR140	111	31,00
FG 75/CO10	141	21,50	FG 75/TIN5	140	3,20	FG 78/HSS65	138	15,00	FG 81/BMZ140	111	31,00
FG 75/CO10,5	141	25,00	FG 75/TIN5,5	140	3,80	FG 78/HSS67	138	15,30	FG 81/BT125	110	31,00
FG 75/CO11	141	28,00	FG 75/TIN6	140	4,20	FG 78/HSS68	138	15,30	FG 81/8AR	133	11,50
FG 75/CO11,5	141	30,00	FG 75/TIN6,5	140	4,60	FG 78/HSS70	138	16,20	FG 81/8AM	133	15,00
FG 75/CO12	141	33,50	FG 75/TIN7	140	5,10	FG 78/HSS73	138	16,50	FG 81/8AP	133	14,50
FG 75/CO12,5	141	36,00	FG 75/TIN7,5	140	6,30	FG 78/HSS76	138	17,30	FG 81/8AT	133	14,50
FG 75/CO13	141	40,00	FG 75/TIN8	140	7,30	FG 78/HSS79	138	18,40	FG 81/8AQ	133	14,50
FG 75CO/S19	141	110,00	FG 75/TIN8,5	140	9,00	FG 78/HSS83	138	21,00	FG 81/S5B	133	75,00
FG 75CO/S25	141	230,00	FG 75/TIN9	140	9,80	FG 78/HSS86	138	21,50	FG 81/C1	155	20,00
FG 75/HSS0,5	140	1,80	FG 75/TIN9,5	140	11,00	FG 78/HSS89	138	22,00	FG 81/C2	155	24,00
FG 75/HSS1	140	1,40	FG 75/TIN10	140	11,30	FG 78/HSS92	138	23,00	FG 81/C3	155	31,00
FG 75/HSS1,25	140	1,40	FG 75/TIN10,5	140	12,60	FG 78/HSS95	138	24,00	FG 81/C4	155	36,00
FG 75/HSS1,5	140	1,20	FG 75/TIN11	140	13,50	FG 78/HSS98	138	25,00	FG 81/C5	155	44,00
FG 75/HSS1,75	140	1,20	FG 75/TIN11,5	140	14,80	FG 78/HSS102	138	27,00	FG 81/MS	156	0,70
FG 75/HSS2	140	1,10	FG 75/TIN12	140	15,50	FG 78/HSS105	138	28,50	FG 81/PT1	156	23,00
FG 75/HSS2,25	140	1,30	FG 75/TIN12,5	140	17,00	FG 78/HSS108	138	29,50	FG 81/PT2	156	8,50
FG 75/HSS2,5	140	1,20	FG 75/TIN13	140	19,00	FG 78/HSS111	138	31,00	FG 81/S1	155	17,50
FG 75/HSS2,75	140	1,80	FG 75TIN/S13	140	58,00	FG 78/HSS114	138	33,00	FG 81/S2	155	20,00
FG 75/HSS3	140	1,40	FG 75TIN/S19	140	90,00	FG 78/HSS121	138	35,00	FG 81/S3	155	27,50
FG 75/HSS3.1	140	1,60	FG 75TIN/S25	140	185,00	FG 78/HSS127	138	36,00	FG 81/S4	155	32,00
FG 75/HSS3,2	140	1,80	FG 76/HSS14	140	22,00	FG 78/HSS133	138	39,00	FG 81/S5	155	38,00
FG 75/HSS3,25	140	1,60	FG 76/HSS15	140	26,00	FG 78/HSS140	138	42,00	FG 81HSS/1	137	44,00
FG 75/HSS3,5	140	1,50	FG 76/HSS16	140	29,00	FG 78/HSS146	138	44,00	FG 81HSS/2	137	62,00
FG 75/HSS3,75	140	1,90	FG 76/HSS17	140	34,00	FG 78/HSS152	138	48,00	FG 81HSS/3	137	135,00
FG 75/HSS4	140	1,70	FG 76/HSS18	140	40,00	FG 78/PC1	138	8,00	FG 81HSS/S3	137	240,00
FG 75/HSS4.1	140	2,00	FG 76/HSS19	140	42,00	FG 78/PR1	138	21,00	FG 82/DRA120	112	31,00
FG 75/HSS4,2	140	2,00	FG 76/HSS20	140	48,00	FG 78/SP1	138	2,50	FG 82/DRA130	112	34,50
FG 75/HSS4,25	140	2,10	FG 76/R1	141	15,00	FG 78HSS/S12	139	220,00	FG 82/DRS120	112	31,00
FG 75/HSS4,5	140	1,90	FG 76/R2	141	24,50	FG 78HSS/S17	139	300,00	FG 82/DRS130	112	35,00
FG 75/HSS4,75	140	2,30	FG 76/R3	141	40,00	FG 79/SB	293	23,00	FG 82/DSA120	112	31,00
FG 75/HSS5	140	2,00	FG 76/R4	141	52,00	FG 79/SP	278	4,00	FG 82/RAS120	112	31,00
FG 75/HSS5,1	140	2,70	FG 77/PVC1	141	34,00	FG 79/SP2	278	9,00	FG 82/RAS130	112	35,00
FG 75/HSS5,25	140	3,00	FG 77/PVC3	141	24,00	FG 79/SP3	278	5,20	FG 82/TDS120	112	31,00
FG 75/HSS5,5	140	2,70	FG 77/PVC4	141	70,00	FG 79/SP4	278	5,00	FG 82/RST	132	11,50
FG 75/HSS5,75	140	3,20	FG 77/PVC4-R	141	30,00	FG 79/SR	293	16,50	FG 82/RP	132	11,50

CODE	PAGE	€/Pz	CODE	PAGE	€/Pz	CODE	PAGE	€/Pz	CODE	PAGE	€/Pz
FG 83/AR	133	5,00	FG 85/25T30	86	1,70	FG 85/TW4	109	12,30	FG 87/H6	89	3,00
FG 83/AT	133	5,00	FG 85/25T40	86	1,70	FG 85/TW5	109	12,30	FG 87/H8	89	3,00
FG 83/AQ	133	5,00	FG 85/25T45	86	1,90	FG 86/AD2	88	5,50	FG 87/H10	89	4,00
FG 83/AM	133	5,00	FG 85/25T50	86	2,10	FG 86/S30	89	85,00	FG 87/PH1	89	3,00
FG 83/AP	133	5,00	FG 85/25TT10	85	2,10	FG 86/S30B	89	85,00	FG 87/PH2	89	3,00
FG 83/AW	133	5,00	FG 85/25TT15	85	2,10	FG 86/30H4	88	1,60	FG 87/PH3	89	3,00
FG 83/S6	133	30,00	FG 85/25TT20	85	2,10	FG 86/30H5	88	1,60	FG 87/PH4	89	3,00
FG 83/TD130	113	35,00	FG 85/25TT25	85	2,10	FG 86/30H6	88	1,60	FG 87/PZ1	89	3,50
FG 83/TF120	113	31,00	FG 85/25TT27	85	2,10	FG 86/30H7	88	1,60	FG 87/PZ2	89	3,50
FG 84/ORS130	113	35,00	FG 85/25TT30	85	2,10	FG 86/30H8	88	1,60	FG 87/PZ3	89	3,50
FG 84/TOR130	113	35,00	FG 85/25TT40	85	2,10	FG 86/30H10	88	1,60	FG 87/PZ4	89	3,50
FG 84/F1	109	4,40	FG 85/25Z1	85	1,10	FG 86/30H12	88	2,50	FG 87/TX20	89	4,00
FG 84/F2	109	4,40	FG 85/25Z2	85	1,10	FG 86/30H14	88	3,40	FG 87/TX25	89	4,00
FG 84/F3	109	4,40	FG 85/25Z3	85	1,10	FG 86/30M5	88	2,00	FG 87/TX27	89	4,00
FG 84/F4	109	4,40	FG 85/25Z4	85	1,10	FG 86/30M6	88	2,00	FG 87/TX30	89	4,00
FG 84/F5	109	4,40	FG 85/25Z4	85	1,50	FG 86/30M8	88	2,00	FG 87/TX40	89	4,00
FG 84/F7	109	4,40	FG 85/50F1	85	3,00	FG 86/30M10	88	2,00	FG 87/TX45	89	4,00
FG 84/H1.5	109	5,20	FG 85/50F2	85	3,00	FG 86/30M12	88	2,90	FG 87/TX50	89	6,00
FG 84/H2	109	5,20	FG 85/50F3	85	3,00	FG 86/30M14	88	3,40	FG 87/TX55	89	6,00
FG 84/H2.5	109	5,20	FG 85/50F4	85	3,00	FG 86/30T20	88	1,60	FG 88/100SDS	87	22,50
FG 84/H3	109	5,20	FG 85/50F5	85	3,00	FG 86/30T25	88	1,60	FG 88/60PI1	87	10,00
FG 84/PH0	109	4,40	FG 85/50F6	85	3,50	FG 86/30T27	88	1,60	FG 88/60PI2	87	9,00
FG 84/PH00	109	4,40	FG 85/50F7	85	3,50	FG 86/30T30	88	1,60	FG 88/60PI3	87	12,50
FG 84/PH1	109	4,40	FG 85/50H3	85	3,30	FG 86/30T40	88	1,60	FG 88/75PB1	88	16,50
FG 84/TX3	109	5,10	FG 85/50H4	85	3,30	FG 86/30T45	88	1,60	FG 88/75PB2	88	19,50
FG 84/TX4	109	5,10	FG 85/50H5	85	3,30	FG 86/30T50	88	1,60	FG 88/75PB3	88	22,50
FG 84/TX5	109	5,10	FG 85/50H6	85	3,30	FG 86/30T55	88	1,60	FG 88/P14	87	24,00
FG 84/TX6	109	5,10	FG 85/50H7	85	4,00	FG 86/30TT20	88	1,70	FG 89/38PI1	88	19,50
FG 84/TX7	109	5,10	FG 85/50H8	85	4,00	FG 86/30TT25	88	1,70	FG 89/50PI2	88	22,50
FG 84/TX8	109	5,10	FG 85/50H10	85	4,00	FG 86/30TT27	88	1,70	FG 89/50PI3	88	23,00
FG 84/TX9	109	5,10	FG 85/50PH1	85	3,50	FG 86/30TT30	88	1,70	FG 89/55PI4	88	26,00
FG 84/TX10	109	5,10	FG 85/70PH1	85	5,00	FG 86/30TT30	88	1,70	FG 89/55PI5	88	28,00
FG 84/TX15	109	5,10	FG 85/50PH2	85	3,50	FG 86/30TT40	88	1,70	FG 92/GR	279	26,50
FG 84/TX20	109	5,10	FG 85/70PH2	85	5,00	FG 86/30TT45	88	1,70	FG 93/M50	279	30,00
FG 84TX/S6	109	32,00	FG 85/50PH3	85	3,50	FG 86/30TT50	88	1,70	FG 93/M95	279	30,00
FG 84F/S6	109	29,00	FG 85/70PH3	85	5,00	FG 86/30TT55	88	1,70	FG 92/PM	279	19,00
FG 84F/S6B	109	29,00	FG 85/50T9	86	4,20	FG 86/75H4	88	3,00	FG 92/PF	279	27,50
FG 84F/S6C	109	29,00	FG 85/50T10	86	4,20	FG 86/75H5	88	3,00	FG 92/PM1	279	10,50
FG 84PH/S6	109	29,00	FG 85/50T15	86	4,20	FG 86/75H6	88	3,00	FG 92/PM4	279	27,50
FG 84PH/S6B	109	29,00	FG 85/50T20	86	4,20	FG 86/75H7	88	3,00	FG 93/P	279	3,50
FG 85/25F1	85	1,20	FG 85/50T25	86	4,20	FG 86/75H8	88	3,00	FG 94/300	155	28,00
FG 85/25F2	85	1,20	FG 85/50T27	86	4,20	FG 86/75H10	88	3,00	FG 94/600	155	38,00
FG 85/25F3	85	1,20	FG 85/50T30	86	4,20	FG 86/75H12	88	4,00	FG 94/800	155	54,00
FG 85/25F4	85	1,20	FG 85/50T40	86	4,20	FG 86/75H14	88	5,50	FG 94/1000	155	70,00
FG 85/25F5	85	1,20	FG 85/50T45	86	5,20	FG 86/75M5	88	3,50	FG 94/MI	349	52,00
FG 85/25F6	85	2,00	FG 85/50T50	86	5,20	FG 86/75M6	88	3,50	FG 94/MS	349	34,00
FG 85/25F7	85	2,00	FG 85/50Z1	86	3,50	FG 86/75M8	88	3,50	FG 94/R	349	20,00
FG 85/25H1.5	85	1,30	FG 85/50Z2	86	3,50	FG 86/75M10	88	3,60	FG 94/T	349	17,00
FG 85/25H2	85	1,30	FG 85/50Z3	86	3,50	FG 86/75M12	88	3,90	FG 95/BA	157	75,00
FG 85/25H2.5	85	1,30	FG 85/100F3	87	5,00	FG 86/75T20	88	2,70	FG 95/CA	156	50,00
FG 85/25H3	85	1,30	FG 85/100F4	87	5,00	FG 86/75T25	88	2,70	FG 95/CA2	157	125,00
FG 85/25H4	85	1,30	FG 85/100F5.5	87	5,00	FG 86/75T27	88	2,70	FG 95/CF	156	16,00
FG 85/25H5	85	1,30	FG 85/100PH1	87	5,40	FG 86/75T30	88	2,70	FG 95/CO	157	110,00
FG 85/25H6	85	1,30	FG 85/100PH2	87	5,40	FG 86/75T40	88	2,70	FG 95/CP1	156	95,00
FG 85/25H7	85	1,70	FG 85/100PH3	87	5,40	FG 86/75T45	88	2,70	FG 95/DG	156	90,00
FG 85/25H8	85	1,70	FG 85/100PH4	87	5,40	FG 86/75T50	88	2,70	FG 95/GO1	157	70,00
FG 85/25H10	85	2,20	FG 85/100PZ1	87	5,40	FG 86/75T55	88	2,70	FG 95/GO2	157	86,00
FG 85/25M4	85	1,10	FG 85/100PZ2	87	5,40	FG 86/75TT20	88	3,00	FG 95/GO3	157	102,00
FG 85/25M5	85	1,10	FG 85/100PZ3	87	5,40	FG 86/75TT25	88	3,00	FG 95/M1	157	56,00
FG 85/25M6	85	1,10	FG 85/100H4	87	5,20	FG 86/75TT27	88	3,00	FG 95/M2	157	60,00
FG 85/25M10	85	1,10	FG 85/100H5	87	5,20	FG 86/75TT30	88	3,00	FG 95/M3	157	70,00
FG 85/25PH0	85	1,60	FG 85/100H6	87	5,20	FG 86/75TT40	88	3,00	FG 95/M4	157	86,00
FG 85/25PH1	85	1,70	FG 85/100T15	87	5,40	FG 86/75TT45	88	3,00	FG 95/SP100	280	65,00
FG 85/25PH2	85	1,70	FG 85/100T20	87	5,40	FG 86/75TT50	88	3,00	FG 95/TIP1	280	7,00
FG 85/25PH3	85	1,70	FG 85/100T25	87	5,40	FG 86/75TT55	88	3,00	FG 96/DG	107	185,00
FG 85/25T9	86	1,70	FG 85/S15L	86	92,00	FG 87/25F1	89	4,00	FG 96/SS30	280	48,00
FG 85/25T10	86	1,70	FG 85/S11	85	28,00	FG 87/25F2	89	4,00	FG 96/SS36	280	62,00
FG 85/25T15	86	1,70	FG 85/S31	86	65,00	FG 87/25F3	89	4,60	FG 96/SS60	280	60,00
FG 85/25T20	86	1,70	FG 85TX/S11	86	32,00	FG 87/25F4	89	5,10	FG 96/TIP1	280	7,00
FG 85/25T25	86	1,70	FG 85/TW1	109	12,30	FG 87/AD	89	6,50	FG 96/TIP2	280	7,00
FG 85/25T27	86	1,70	FG 85/TW2	109	12,30	FG 87/H4	89	3,00	FG 97/T1	157	250,00
			FG 85/TW3	109	12,30	FG 87/H5	89	3,00			

CODE	PAGE	€/Pz	CODE	PAGE	€/Pz	CODE	PAGE	€/Pz	CODE	PAGE	€/Pz
FG 97/T2	157	620,00	FG 100/19	36	220,00	FG 100/48D	330	110,00	FG 100V/7T	315	1.100,00
FG 98/AS	280	3,00	FG 100/19	326	220,00	FG TER 100/48D	330	14,00	FG 100W/7T	315	1.100,00
FG 98/GAS	280	120,00	FG TER 100/18B	326	24,00	FG 100/48G	330	130,00	FG 101V/3G	319	500,00
FG 98/LT	281	170,00	FG 100/19B	38	200,00	FG TER 100/48G	330	24,00	FG 101V/5G	318	680,00
FG 98/PC8	281	16,50	FG 100/19B	326	200,00	FG 100/50E	330	200,00	FG 101V/6G	318	710,00
FG 98/SS	280	12,00	FG TER 100/19B	326	24,00	FG TER 100/50E	330	48,00	FG 101V/7G	318	750,00
FG 98/ST8	281	16,50	FG 100/19IN	40	220,00	FG 100/50F	330	90,00	FG 102/AR	316	120,00
FG 98/STA	280	12,00	FG 100/19IN	326	220,00	FG TER 100/50F	330	24,00	FG 102/PC	349	80,00
FG 98/TIP1	280	16,50	FG TER 100/19IN	326	24,00	FG 100/50G	330	90,00	FG 102/PA	349	30,00
FG 98/TIP2	280	16,50	FG 100/20B	44	265,00	FG TER 100/50G	330	24,00	FG 102/PL	349	58,00
FG 98/TIP3	280	16,50	FG 100/21B	44	240,00	FG 100/51H	330	140,00	FG 100/PR	349	62,00
FG 98/TIP4	280	16,50	FG 100/21B	326	240,00	FG TER 100/51H	330	24,00	FG 102/TG	349	50,00
FG 99	202	550,00	FG TER 100/21B	326	24,00	FG 100/52A	330	184,00	FG 102B/5G	316	960,00
FG 99/B	202	670,00	FG 100/21C	46	240,00	FG TER 100/52A	330	35,00	FG 102D/5G	316	960,00
FG 99/C	202	1.900,00	FG 100/21C	327	240,00	FG 100/52B	330	166,00	FG 102R/5G	316	960,00
FG 100/AS56	337	1.877,20	FG TER 100/21C	327	24,00	FG TER 100/52B	330	24,00	FG 102V/5G	316	960,00
FG 100/AS161	333	1.319,00	FG 100/21D	327	159,00	FG 100/52C	330	151,00	FG 102B/6G	316	1.030,00
FG 100/AS173	334	1.885,00	FG TER 100/21D	327	24,00	FG TER 100/52C	330	24,00	FG 102D/6G	316	1.030,00
FG 100/AS226	333	1.698,00	FG 100/21E	327	410,00	FG 100/52D	330	103,00	FG 102R/6G	316	1.030,00
FG 100/AS230	334	2.253,00	FG TER 100/21E	327	35,00	FG TER 100/52D	330	24,00	FG 102V/6G	316	1.030,00
FG 100/AS248	336	2.672,00	FG 100/21G	327	330,00	FG 100/52E	330	89,00	FG 102B/7G	317	1.100,00
FG 100/AS304	337	2.703,00	FG TER 100/21G	327	24,00	FG TER 100/52E	330	24,00	FG 102D/7G	317	1.100,00
FG 100/AS171	338	1.789,00	FG 100/21L	45	430,00	FG 100/52F	330	111,00	FG 102R/7G	317	1.100,00
FG 100/AS284	339	2.920,00	FG 100/21H	45	430,00	FG TER 100/52F	330	24,00	FG 102V/7G	317	1.100,00
FG 100/AS360	336	2.694,00	FG 100/21H	327	430,00	FG 100/52G	330	122,00	FG 102B/8G	317	1.150,00
FG 100/03E	324	90,00	FG TER 100/21H	327	35,00	FG TER 100/52G	330	24,00	FG 102D/8G	317	1.150,00
FG TER 100/03E	324	24,00	FG 100/21IN	48	260,00	FG 100/52H	330	232,00	FG 102R/8G	317	1.150,00
FG 100/03F	324	100,00	FG 100/21IN	328	260,00	FG TER 100/52H	330	70,00	FG 102V/8G	317	1.150,00
FG TER 100/03F	324	24,00	FG TER 100/21IN	328	24,00	FG 100/53	330	310,00	FG 102/03G	340	135,00
FG 100/03G	324	150,00	FG 100/21M	328	159,00	FG TER 100/53	330	35,00	FG TER 102/03G	340	15,00
FG TER 100/03G	324	24,00	FG TER 100/21M	328	24,00	FG 100/53B	330	570,00	FG 102/03L	340	145,00
FG 100/03L	324	145,00	FG 100/21TX	328	255,00	FG TER 100/53B	330	35,00	FG TER 102/03L	340	15,00
FG TER 100/03L	324	24,00	FG TER 100/21TX	328	24,00	FG 100/54	332	160,00	FG 102/03H	340	250,00
FG 100/03H	324	290,00	FG 100/23B	328	360,00	FG TER 100/54	332	24,00	FG TER 102/03H	340	20,00
FG TER 100/03H	324	48,00	FG TER 100/23B	328	35,00	FG 100/55B	332	114,00	FG 102/03E	340	80,00
FG 100/03IN	325	122,50	FG 100/23C	328	220,00	FG TER 100/55B	332	24,00	FG TER 102/03E	340	15,00
FG TER 100/03IN	325	24,00	FG TER 100/23C	328	24,00	FG 100/56C	331	130,00	FG 102/03F	340	92,00
FG 100/03TX	324	60,00	FG 100/25	63	420,00	FG TER 100/56C	331	24,00	FG TER 102/03F	340	20,00
FG TER 100/03TX	324	15,00	FG 100/25	328	420,00	FG 100/62B	332	95,00	FG 102/07C	340	92,00
FG 100/07C	324	105,00	FG TER 100/25	328	35,00	FG TER 100/62B	332	24,00	FG TER 102/07C	340	15,00
FG TER 100/07C	324	24,00	FG 100/25B	63	420,00	FG 100/65B	332	78,00	FG 102/07D	340	135,00
FG 100/07D	324	145,00	FG 100/25B	328	420,00	FG TER 100/65B	332	24,00	FG TER 102/07D	340	15,00
FG TER 100/07D	324	24,00	FG TER 100/25B	328	35,00	FG 100/65C	332	125,50	FG 102/08C	340	230,00
FG 100/08C	324	240,00	FG 100/39C	328	95,00	FG TER 100/65C	332	24,00	FG TER 102/08C	340	15,00
FG TER 100/08C	324	24,00	FG TER 100/39C	328	24,00	FG 100/68	330	120,00	FG 102/10C	340	330,00
FG 100/10C	324	361,00	FG 100/39XT	328	104,00	FG TER 100/68	330	24,00	FG TER 102/10C	340	24,00
FG TER 100/10C	324	70,00	FG TER 100/39XT	328	24,00	FG 100/76C	332	274,00	FG 102/13C	340	175,00
FG 100/10D	324	523,00	FG 100/41C	328	110,00	FG TER 100/76C	332	24,00	FG TER 102/13C	340	20,00
FG TER 100/10D	324	70,00	FG TER 100/41C	328	24,00	FG 100/81F	332	200,00	FG 102/17	31	125,00
FG 100/10H	324	294,00	FG 100/42C	329	112,00	FG TER 100/81F	332	24,00	FG 102/17	340	125,00
FG TER 100/10H	324	70,00	FG TER 100/42C	329	24,00	FG 100/82B	55	170,00	FG TER 102/17	340	15,00
FG 100/10TX	325	406,00	FG 100/45D	329	65,00	FG TER 100/82B	332	170,00	FG 102/17E	31	265,00
FG TER 100/10TX	325	70,00	FG TER 100/45D	329	24,00	FG 100/82B	332	24,00	FG 102/17E	340	265,00
FG 100/12B	325	171,30	FG 100/45E	329	78,00	FG 100/83B	55	180,00	FG TER 102/17E	340	15,00
FG TER 100/12B	325	24,00	FG TER 100/45E	329	24,00	FG 100/VA1	332	24,00	FG 102/19	36	200,00
FG 100/13C	325	193,60	FG 100/45F	329	68,00	FG 100/VA2	332	14,00	FG 102/19	341	200,00
FG TER 100/13C	325	24,00	FG TER 100/45F	329	23,00	FG 100/VA3	332	24,00	FG TER 102/19	341	15,00
FG 100/17	31	135,00	FG 100/45G	329	68,00	FG 100/VA4	332	21,00	FG 102/19B	38	180,00
FG 100/17	325	135,00	FG TER 100/45G	329	24,00	FG 100B/5T	315	1.000,00	FG 102/19B	341	180,00
FG TER 100/17	325	24,00	FG 100/45H	329	80,00	FG 100D/5T	315	1.000,00	FG 102/21B	44	230,00
FG 100/17E	31	285,00	FG TER 100/45H	329	48,00	FG 100R/5T	315	1.000,00	FG 102/21B	341	230,00
FG 100/17E	325	285,00	FG 100/45I	329	80,00	FG 100V/5T	315	1.000,00	FG TER 102/21B	341	15,00
FG TER 100/17E	325	24,00	FG TER 100/45I	329	24,00	FG 100W/5T	315	1.000,00	FG 102/21C	46	230,00
FG 100/17IN	325	164,40	FG 100/45L	329	84,00	FG 100B/6T	315	1.050,00	FG 102/21C	341	230,00
FG TER 100/17IN	325	24,00	FG TER 100/45L	329	24,00	FG 100D/6T	315	1.050,00	FG TER 102/21C	341	15,00
FG 100/18	37	295,00	FG 100/45M	330	70,80	FG 100R/6T	315	1.050,00	FG 102/21D	341	165,00
FG 100/18	326	295,00	FG TER 100/45M	330	23,00	FG 100V/6T	315	1.050,00	FG TER 102/21D	341	15,00
FG TER 100/18	326	24,00	FG 100/45Q	330	129,00	FG 100W/6T	315	1.050,00	FG 102/21E	341	165,00
FG 100/18B	39	250,00	FG TER 100/45Q	330	24,00	FG 100B/7T	315	1.100,00	FG TER 102/21E	341	15,00
FG 100/18B	326	250,00	FG 100/45T	330	85,00	FG 100D/7T	315	1.100,00	FG 102/21H	342	200,00
FG TER 100/18B	326	24,00	FG TER 100/45T	330	24,00	FG 100R/7T	315	1.100,00	FG TER 102/21H	342	15,00

CODE	PAGE	€/Pz	CODE	PAGE	€/Pz	CODE	PAGE	€/Pz	CODE	PAGE	€/Pz
FG 102/21R	54	220,00	FG 104R/7G	317	1.350,00	FG 116/CO30V	397	8.070,00	FG 118B/205C	381	2.200,00
FG 102/21R	342	220,00	FG 104V/7G	317	1.350,00	FG 116/CO32V	397	9.890,00	FG 118R/205C	381	2.200,00
FG TER 102/21R	342	15,00	FG 104/TG	349	65,00	FG 118/AS40	307	1.055,50	FG 118V/205D	382	2.980,00
FG 102/21TX	50	235,00	FG 105B/5G	320	1.300,00	FG 118/AS44	309	573,40	FG 118B/205D	382	2.980,00
FG 102/21TX	341	235,00	FG 105D/5G	320	1.300,00	FG 118/AS47	311	467,10	FG 118R/205D	382	2.980,00
FG TER 102/21TX	341	15,00	FG 105R/5G	320	1.300,00	FG 118/AS56	308	749,90	FG 118V/205E	382	3.950,00
FG 102/23C	342	145,50	FG 105V/5G	320	1.300,00	FG 118/AS75	310	564,40	FG 118B/205E	382	3.950,00
FG TER 102/23C	342	15,00	FG 105B/6G	320	1.400,00	FG 118/AS76	306	848,90	FG 118R/205E	382	3.950,00
FG 102/25	63	395,00	FG 105D/6G	320	1.400,00	FG 118V/40A	386	740,00	FG 118V/205F	382	2.400,00
FG 102/25	342	395,00	FG 105R/6G	320	1.400,00	FG 118B/40A	386	740,00	FG 118B/205F	382	2.400,00
FG TER 102/25	342	20,00	FG 105V/6G	320	1.400,00	FG 118R/40A	386	740,00	FG 118R/205F	382	2.400,00
FG 102/25B	63	395,00	FG 105B/7G	320	1.450,00	FG 118M/40B	386	1.960,00	FG 118V/205G	385	2.150,00
FG 102/25B	342	395,00	FG 105D/7G	320	1.450,00	FG 118M/40C	386	2.100,00	FG 118B/205G	385	2.150,00
FG TER 102/25B	342	20,00	FG 105R/7G	320	1.450,00	FG 118M/40D	387	900,00	FG 118R/205G	385	2.150,00
FG 102/39C	342	85,00	FG 105V/7G	320	1.450,00	FG 118M/40H	386	1.150,00	FG 118V/205H	385	2.400,00
FG TER 102/39C	342	15,00	FG 106/A	365	250,00	FG 118V/40E	387	740,00	FG 118B/205H	385	2.400,00
FG 102/39XT	342	95,00	FG 106/B	365	300,00	FG 118B/40E	387	740,00	FG 118R/205H	385	2.400,00
FG TER 102/39XT	342	15,00	FG 106/C	365	390,00	FG 118R/40E	387	740,00	FG 118V/205L	378	3.680,00
FG 102/39D	342	70,00	FG 107/A	365	165,00	FG 118V/40F	387	740,00	FG 118B/205L	378	3.680,00
FG TER 102/39D	342	15,00	FG 109D/6G	321	1.600,00	FG 118B/40F	387	740,00	FG 118R/205L	378	3.680,00
FG 102/41C	342	95,00	FG 109B/6G	321	1.600,00	FG 118R/40F	387	740,00	FG 118V/205M	378	4.650,00
FG TER 102/41C	342	15,00	FG 109R/6G	321	1.600,00	FG 118M/40G	386	1.960,00	FG 118B/205M	378	4.650,00
FG 102/42C	343	100,00	FG 109D/7G	321	1.650,00	FG 118V/69A	388	950,00	FG 118R/205M	378	4.650,00
FG TER 102/42C	343	15,00	FG 109B/7G	321	1.650,00	FG 118B/69A	388	950,00	FG 118V/205P	379	3.250,00
FG 102/45D	343	45,00	FG 109R/7G	321	1.650,00	FG 118R/69A	388	950,00	FG 118B/205P	379	3.250,00
FG TER 102/45D	343	15,00	FG 108/B	319	250,00	FG 118M/69B	388	3.400,00	FG 118R/205P	379	3.250,00
FG 102/45E	343	55,00	FG 109/L3	302	280,00	FG 118M/69G	388	3.400,00	FG 118V/205Q	379	3.150,00
FG TER 102/45E	343	15,00	FG 110	319	380,00	FG 118M/69H	388	1.350,00	FG 118B/205Q	379	3.150,00
FG 102/45F	343	52,00	FG 111/A	296	60,00	FG 118V/69E	388	950,00	FG 118R/205Q	379	3.150,00
FG TER 102/45F	343	15,00	FG 111/B	296	72,00	FG 118B/69E	388	950,00	FG 118V/122A	383	1.750,00
FG 102/45G	343	50,00	FG 111/C	296	85,00	FG 118R/69E	388	950,00	FG 118B/122A	383	1.750,00
FG TER 102/45G	343	15,00	FG 111/AS55	297	616,50	FG 118/69V5	389	1.160,00	FG 118R/122A	383	1.750,00
FG 102/45U	343	90,00	FG 111/AS104	297	835,80	FG 118/69B5	389	1.160,00	FG 118V/122B	383	1.360,00
FG TER 102/45U	343	20,00	FG 112A	296	210,00	FG 118/69R5	389	1.160,00	FG 118B/122B	383	1.360,00
FG 102/45I	343	62,00	FG 112B	296	250,00	FG 118/69V6	389	1.220,00	FG 118R/122B	383	1.360,00
FG TER 102/45I	343	15,00	FG 112/C	296	240,00	FG 118/69B6	389	1.220,00	FG 118V/122C	383	3.500,00
FG 102/45L	343	65,00	FG 112/D	296	290,00	FG 118/69R6	389	1.220,00	FG 118B/122C	383	3.500,00
FG TER 102/45L	343	15,00	FG 114/L2	302	65,00	FG 118/69V7	389	1.280,00	FG 118R/122C	383	3.500,00
FG 102/45T	343	65,00	FG 114/L3	302	110,00	FG 118/69B7	389	1.280,00	FG 118V/122H	385	1.420,00
FG TER 102/45T	343	15,00	FG 115/A	304	250,00	FG 118/69R7	389	1.280,00	FG 118B/122H	385	1.420,00
FG 102/48D	343	95,00	FG 115/B	304	290,00	FG 118V/5T	390	1.280,00	FG 118R/122H	385	1.420,00
FG TER 102/48D	343	15,00	FG 116/A	305	390,00	FG 118B/5T	390	1.280,00	FG 118V/138AN	384	1.480,00
FG 102/48G	343	120,00	FG 117/A	305	420,00	FG 118R/5T	390	1.280,00	FG 118B/138AN	384	1.480,00
FG TER 102/48G	343	15,00	FG 116V/68A	400	715,00	FG 118V/6T	390	1.340,00	FG 118R/138AN	384	1.480,00
FG 102/50F	343	76,00	FG 116V/68B	400	960,00	FG 118B/6T	390	1.340,00	FG 118V/138ANT	384	1.020,00
FG TER 102/50F	343	15,00	FG 116V/68C	400	1.050,00	FG 118R/6T	390	1.340,00	FG 118B/138ANT	384	1.020,00
FG 102/50G	344	76,00	FG 116V/68D	401	930,00	FG 118V/7T	390	1.400,00	FG 118R/138ANT	384	1.020,00
FG TER 102/50G	344	15,00	FG 116M/68E	401	1.180,00	FG 118B/7T	390	1.400,00	FG 118/CO1V	370	6.110,00
FG 102/51H	344	130,00	FG 116V/68F	401	1.160,00	FG 118R/7T	390	1.400,00	FG 118/CO1B	370	6.110,00
FG TER 102/51H	344	15,00	FG 116V/68G	401	1.040,00	FG 118/AR1V	390	720,00	FG 118/CO1R	370	6.110,00
FG 102/56C	344	120,00	FG 116/68V7	402	850,00	FG 118/AR1B	390	720,00	FG 118/CO2V	370	5.840,00
FG TER 102/56C	344	15,00	FG 116/68V6	402	820,00	FG 118/AR1R	390	720,00	FG 118/CO2B	370	5.840,00
FG 102/60C	344	45,00	FG 116/68V5	402	790,00	FG 118/AR2V	391	1.100,00	FG 118/CO2R	370	5.840,00
FG TER 102/60C	344	15,00	FG 116V/7G	403	800,00	FG 118/AR2B	391	1.100,00	FG 118/CO3V	371	6.560,00
FG 102/62B	344	90,00	FG 116V/6G	403	780,00	FG 118/AR2R	391	1.100,00	FG 118/CO3B	371	6.560,00
FG TER 102/62B	344	15,00	FG 116V/5G	403	750,00	FG 118/AR3V	391	1.750,00	FG 118/CO3R	371	6.560,00
FG 102/65B	344	65,00	FG 116V/207A	399	1.830,00	FG 118/AR3B	391	1.750,00	FG 118/CO4V	371	8.560,00
FG TER 102/65B	344	15,00	FG 116/207B	399	1.040,00	FG 118/AR3R	391	1.750,00	FG 118/CO4B	371	8.560,00
FG 102/VA1	344	15,00	FG 116V/138A	399	1.280,00	FG 118V/80AN	384	1.380,00	FG 118/CO4R	371	8.560,00
FG 102/AS149	346	1.312,00	FG 116/138B	399	760,00	FG 118B/80AN	384	1.380,00	FG 118/CO5V	372	7.080,00
FG 102/AS158	347	1.504,00	FG 116/50AN	399	950,00	FG 118R/80AN	384	1.380,00	FG 118/CO5B	372	7.080,00
FG 102/AS190	345	1.435,50	FG 116/CO1V	394	4.770,00	FG 118V/80ANT	384	920,00	FG 118/CO5R	372	7.080,00
FG 102/AS193	348	1.462,00	FG 116/CO2V	395	4.305,00	FG 118B/80ANT	384	920,00	FG 118/CO6V	372	8.520,00
FG 102/AS356	345	2.519,00	FG 116/CO3V	394	5.025,00	FG 118R/80ANT	384	920,00	FG 118/CO6B	372	8.520,00
FG 104/AR	316	120,00	FG 116/CO4V	395	6.125,00	FG 118V/205A	381	2.750,00	FG 118/CO6R	372	8.520,00
FG 104B/6G	317	1.250,00	FG 116/CO6V	394	4.355,00	FG 118B/205A	381	2.750,00	FG 118/CO7V	373	4.400,00
FG 104D/6G	317	1.250,00	FG 116/CO10V	394	3.535,00	FG 118R/205A	381	2.750,00	FG 118/CO7B	373	4.400,00
FG 104R/6G	317	1.250,00	FG 116/CO14V	396	2.540,00	FG 118V/205B	381	3.700,00	FG 118/CO7R	373	4.400,00
FG 104V/6G	317	1.250,00	FG 116/CO15V	396	3.060,00	FG 118B/205B	381	3.700,00	FG 118/CO8V	373	3.770,00
FG 104B/7G	317	1.350,00	FG 116/CO16V	396	3.505,00	FG 118R/205B	381	3.700,00	FG 118/CO8B	373	3.770,00
FG 104D/7G	317	1.350,00	FG 116/CO17V	396	2.985,00	FG 118V/205C	381	2.200,00	FG 118/CO8R	373	3.770,00



CODE	PAGE	€/Pz	CODE	PAGE	€/Pz	CODE	PAGE	€/Pz	CODE	PAGE	€/Pz
FG 118/CO9V	374	5.530,00	FG 119V/CO22	410	3.470,00	FG 119V/C49-5B	420	1.020,00	FG 119/M30-23	427	116,00
FG 118/CO9B	374	5.530,00	FG 119B/CO23	410	3.150,00	FG 119B/C49-6B	420	1.100,00	FG 119/M30-40	427	167,00
FG 118/CO9R	374	5.530,00	FG 119R/CO23	410	3.150,00	FG 119R/C49-6B	420	1.100,00	FG 119/M40-23	427	132,00
FG 118/CO10V	374	5.240,00	FG 119V/CO23	410	3.150,00	FG 119V/C49-6B	420	1.100,00	FG 119/M40-40	427	194,00
FG 118/CO10B	374	5.240,00	FG 119B/CO24	411	2.890,00	FG 119B/C49-VB	420	1.450,00	FG 119/M40-56	427	268,00
FG 118/CO10R	374	5.240,00	FG 119R/CO24	411	2.890,00	FG 119R/C49-VB	420	1.450,00	FG 119/MRT20-9	427	66,00
FG 118/CO15V	375	3.850,00	FG 119V/CO24	411	2.890,00	FG 119V/C49-VB	420	1.450,00	FG 119/MRT30-9	427	74,00
FG 118/CO15B	375	3.850,00	FG 119B/CO25	411	2.930,00	FG 119B/C49-2	421	630,00	FG 119/MRT40-9	427	81,00
FG 118/CO15R	375	3.850,00	FG 119R/CO25	411	2.930,00	FG 119R/C49-2	421	630,00	FG 119/BL	428	850,00
FG 118/CO16V	375	3.440,00	FG 119V/CO25	411	2.930,00	FG 119V/C49-2	421	630,00	FG 119/PM	428	1.250,00
FG 118/CO16B	375	3.440,00	FG 119B/CO26	411	3.050,00	FG 119B/C49-3	421	710,00	FG 119/BIN178	429	16,00
FG 118/CO16R	375	3.440,00	FG 119R/CO26	411	3.050,00	FG 119R/C49-3	421	710,00	FG 119/BIN330	429	21,00
FG 118/CO20V	376	14.420,00	FG 119V/CO26	411	3.050,00	FG 119V/C49-3	421	710,00	FG 119/BIN483	429	25,00
FG 118/CO20B	376	14.420,00	FG 119B/CO27	415	3.040,00	FG 119B/C49-4	421	800,00	FG 119/BIN635	429	32,00
FG 118/CO20R	376	14.420,00	FG 119R/CO27	415	3.040,00	FG 119R/C49-4	421	800,00	FG 119/BIN787	429	36,00
FG 118/CO21V	377	17.840,00	FG 119V/CO27	415	3.040,00	FG 119V/C49-4	421	800,00	FG 119/BIN940	429	55,00
FG 118/CO21B	377	17.840,00	FG 119B/CO31	412	4.500,00	FG 119B/C49-V1	421	1.030,00	FG 119/BIN3000	429	92,00
FG 118/CO21R	377	17.840,00	FG 119R/CO31	412	4.500,00	FG 119R/C49-V1	421	1.030,00	FG 119/BIN-T	429	6,00
FG 118/LED	379	96,00	FG 119V/CO31	412	4.500,00	FG 119V/C49-V1	421	1.030,00	FG 119/BP1000	429	140,00
FG 118/TR	379	80,00	FG 119B/CO32	412	4.170,00	FG 119M/C49-V2	422	660,00	FG 119/BP1300	429	160,00
FG 118/NBR1	379	98,00	FG 119R/CO32	412	4.170,00	FG 119B/C73-2	422	700,00	FG 119/BP1750	429	170,00
FG 118/NBR2	379	120,00	FG 119V/CO32	412	4.170,00	FG 119R/C73-2	422	700,00	FG 119/C75-A	429	17,00
FG 118/NBR3	379	120,00	FG 119B/CO33	412	4.170,00	FG 119V/C73-2	422	700,00	FG 119/C150-A	429	21,00
FG 119B/CO1	406	2.015,00	FG 119R/CO33	412	4.170,00	FG 119B/C73-3	422	800,00	FG 119/C100-B	429	18,00
FG 119R/CO1	406	2.015,00	FG 119V/CO33	412	4.170,00	FG 119R/C73-3	422	800,00	FG 119/C200-B	429	18,00
FG 119V/CO1	406	2.015,00	FG 119B/CO34	413	3.530,00	FG 119V/C73-3	422	800,00	FG 119/C100-C	429	26,00
FG 119B/CO2	406	2.020,00	FG 119R/CO34	413	3.530,00	FG 119B/C73-4	422	900,00	FG 119/C200-C	429	33,00
FG 119R/CO2	406	2.020,00	FG 119V/CO34	413	3.530,00	FG 119R/C73-4	422	900,00	FG 119/C400D	429	32,00
FG 119V/CO2	406	2.020,00	FG 119B/CO35	413	3.950,00	FG 119V/C73-4	422	900,00	FG 119/IP1	429	6,50
FG 119B/CO3	406	1.750,00	FG 119R/CO35	413	3.950,00	FG 119B/C98-2	423	790,00	FG 119/IP2	429	10,00
FG 119R/CO3	406	1.750,00	FG 119V/CO35	413	3.950,00	FG 119R/C98-2	423	790,00	FG 119/PC1350	429	160,00
FG 119V/CO3	406	1.750,00	FG 119B/CO36	413	3.700,00	FG 119V/C98-2	423	790,00	FG 119/PC1600	429	170,00
FG 119B/CO4	407	1.530,00	FG 119R/CO36	413	3.700,00	FG 119B/C98-3	423	900,00	FG 119/PC1850	429	190,00
FG 119R/CO4	407	1.530,00	FG 119V/CO36	413	3.700,00	FG 119R/C98-3	423	900,00	FG 119/PC2100	429	200,00
FG 119V/CO4	407	1.530,00	FG 119/49TL	414	130,00	FG 119V/C98-3	423	900,00	FG 119/PF1760	429	190,00
FG 119B/CO5	407	1.570,00	FG 119/73TL	414	220,00	FG 119B/C98-4	423	1.020,00	FG 119/PF2300	429	210,00
FG 119R/CO5	407	1.570,00	FG 119/98TL	414	290,00	FG 119R/C98-4	423	1.020,00	FG 119/ROT3000	429	125,00
FG 119V/CO5	407	1.570,00	FG 119/RI49	417	50,00	FG 119V/C98-4	423	1.020,00	FG 119/ROL3000	429	150,00
FG 119B/CO6	407	1.650,00	FG 119/RI73	417	55,00	FG 119M/C98-V	423	1.190,00	FG 119/TE1	429	10,00
FG 119R/CO6	407	1.650,00	FG 119/RI98	417	65,00	FG 119/RP20-67	424	85,00	FG 119/TE2	429	8,00
FG 119V/CO6	407	1.650,00	FG 100/PL	351	50,00	FG 119/RP30-67	424	110,00	FG 119/P123	430	388,00
FG 119B/CO7	415	1.580,00	FG 119/PR	428	55,00	FG 119/RP40-67	424	130,00	FG 119/P124	430	660,00
FG 119R/CO7	415	1.580,00	FG 119B/BA49	417	380,00	FG 119/RP20-92	424	120,00	FG 119/P125	430	733,60
FG 119V/CO7	415	1.580,00	FG 119R/BA49	417	380,00	FG 119/RP30-92	424	140,00	FG 119/P126	430	733,60
FG 119B/CO11	408	2.900,00	FG 119V/BA49	417	380,00	FG 119/RP40-92	424	160,00	FG 119/P127	430	800,80
FG 119R/CO11	408	2.900,00	FG 119B/BA73	417	410,00	FG 119/RP20-116	424	120,00	FG 119/P128	430	800,80
FG 119V/CO11	408	2.900,00	FG 119R/BA73	417	410,00	FG 119/RP30-116	424	150,00	FG 119/P129	430	988,00
FG 119B/CO12	408	2.920,00	FG 119V/BA73	417	410,00	FG 119/RP40-116	424	170,00	FG 119/P130	430	1.072,80
FG 119R/CO12	408	2.920,00	FG 119B/BA98	418	460,00	FG 119/RP20-141	424	140,00	FG 119/P131	430	988,00
FG 119V/CO12	408	2.920,00	FG 119R/BA98	418	460,00	FG 119/RP30-141	424	175,00	FG 119/P132	430	1.072,80
FG 119M/CO13	408	1.540,00	FG 119V/BA98	418	460,00	FG 119/RP40-141	424	200,00	FG 119/P133	430	1.199,20
FG 119B/CO14	409	2.620,00	FG 119B/BC49	418	430,00	FG 119/RV20-67	425	90,00	FG 119/P134	430	1.199,20
FG 119R/CO14	409	2.620,00	FG 119R/BC49	418	430,00	FG 119/RV30-67	425	95,00	FG 119/P135	430	1.220,00
FG 119V/CO14	409	2.620,00	FG 119V/BC49	418	430,00	FG 119/RV40-67	425	130,00	FG 119/P136	430	1.220,00
FG 119B/CO15	409	2.360,00	FG 119B/BC73	418	470,00	FG 119/RV20-92	425	115,00	FG 119/P137	430	1.376,00
FG 119R/CO15	409	2.360,00	FG 119R/BC73	418	470,00	FG 119/RV30-92	425	135,00	FG 119/P138	430	1.376,00
FG 119V/CO15	409	2.360,00	FG 119V/BC73	418	470,00	FG 119/RV40-92	425	150,00	FG 119/P139	430	1.524,80
FG 119B/CO16	409	2.400,00	FG 119B/BC98	418	540,00	FG 119/RV20-116	425	125,00	FG 119/P140	430	1.524,80
FG 119R/CO16	409	2.400,00	FG 119R/BC98	418	540,00	FG 119/RV30-116	425	135,00	FG 119/P150	430	699,20
FG 119V/CO16	409	2.400,00	FG 119V/BC98	418	540,00	FG 119/RV40-116	425	180,00	FG 119/P151	430	741,60
FG 119B/CO17	409	2.500,00	FG 119/BV98	419	350,00	FG 119/RV20-141	425	140,00	FG 119/P152	430	908,80
FG 119R/CO17	409	2.500,00	FG 119/BV98-2	419	410,00	FG 119/RV30-141	425	160,00	FG 119/P153	430	982,40
FG 119V/CO17	409	2.500,00	FG 119/BV98-3	419	340,00	FG 119/RV40-141	425	210,00	FG 119/P154	430	1.056,80
FG 119B/CO18	415	2.460,00	FG 119B/C49-3B	420	850,00	FG 119/VA20	426	2,00	FG 119/P155	430	1.199,20
FG 119R/CO18	415	2.460,00	FG 119R/C49-3B	420	850,00	FG 119/VA30	426	5,00	FG 119/P156	430	1.199,20
FG 119V/CO18	415	2.460,00	FG 119V/C49-3B	420	850,00	FG 119/VA40	426	13,00	FG 119/P157	430	1.220,00
FG 119B/CO21	410	3.470,00	FG 119B/C49-4B	420	940,00	FG 119/D20	426	9,00	FG 119/P158	430	1.220,00
FG 119R/CO21	410	3.470,00	FG 119R/C49-4B	420	940,00	FG 119/D30	426	12,00	FG 119/P159	430	1.376,00
FG 119V/CO21	410	3.470,00	FG 119V/C49-4B	420	940,00	FG 119/D40	426	14,00	FG 119/P160	430	1.376,00
FG 119B/CO22	410	3.470,00	FG 119B/C49-5B	420	1.020,00	FG 119/M20-23	427	87,00	FG 119/P161	430	1.524,80
FG 119R/CO22	410	3.470,00	FG 119R/C49-5B	420	1.020,00	FG 119/M20-40	427	130,00	FG 119/P162	430	1.524,80

CODE	PAGE	€/Pz	CODE	PAGE	€/Pz	CODE	PAGE	€/Pz	CODE	PAGE	€/Pz
FG 119/P172	430	699,20	FG 119/P279	430	1.577,60	FG 119/R529	430	966,40	FG 119/R637	430	1.562,40
FG 119/P173	430	741,60	FG 119/P280	430	1.577,60	FG 119/R530	430	919,20	FG 119/R638	430	1.709,60
FG 119/P174	430	908,80	FG 119/P281	430	1.671,20	FG 119/R531	430	1.094,40	FG 119/R639	430	1.760,80
FG 119/P175	430	982,40	FG 119/P282	430	1.671,20	FG 119/R532	430	1.095,20	FG 119/R649	430	847,20
FG 119/P176	430	1.056,80	FG 119/P292	430	724,80	FG 119/R533	430	1.156,80	FG 119/R656	430	1.091,20
FG 119/P177	430	1.199,20	FG 119/P293	430	786,40	FG 119/R534	430	1.280,00	FG 119/R658	430	1.305,60
FG 119/P178	430	1.199,20	FG 119/P294	430	989,60	FG 119/R535	430	1.305,60	FG 119/R659	430	1.382,40
FG 119/P179	430	1.220,00	FG 119/P295	430	989,60	FG 119/R536	430	1.510,40	FG 119/R660	430	1.510,40
FG 119/P180	430	1.220,00	FG 119/P296	430	989,60	FG 119/R537	430	1.562,40	FG 119/R661	430	1.562,40
FG 119/P181	430	1.376,00	FG 119/P297	430	1.073,60	FG 119/R538	430	1.709,60	FG 119/R662	430	1.510,40
FG 119/P182	430	1.376,00	FG 119/P298	430	1.073,60	FG 119/R539	430	1.760,80	FG 119/R663	430	1.562,40
FG 119/P183	430	1.524,80	FG 119/P299	430	1.073,60	FG 119/R549	430	709,60	FG 119/R664	430	1.709,60
FG 119/P184	430	1.524,80	FG 119/P300	430	1.073,60	FG 119/R550	430	709,60	FG 119/R665	430	1.760,80
FG 119/P194	430	699,20	FG 119/P301	430	1.380,80	FG 119/R551	430	761,60	FG 119/R675	430	709,60
FG 119/P195	430	741,60	FG 119/P302	430	1.380,80	FG 119/R552	430	837,60	FG 119/R676	430	997,60
FG 119/P196	430	908,80	FG 119/P303	430	1.577,60	FG 119/R553	430	966,40	FG 119/R677	430	1.023,20
FG 119/P197	430	982,40	FG 119/P304	430	1.577,60	FG 119/R554	430	1.095,20	FG 119/R678	430	1.048,80
FG 119/P198	430	1.056,80	FG 119/P305	430	1.694,40	FG 119/R555	430	1.156,80	FG 119/R679	430	1.382,40
FG 119/P199	430	1.179,20	FG 119/P306	430	1.694,40	FG 119/R556	430	1.280,00	FG 119/R681	430	1.433,60
FG 119/P200	430	1.179,20	FG 119/P307	430	1.380,80	FG 119/R557	430	1.305,60	FG 119/R682	430	1.433,60
FG 119/P201	430	1.295,20	FG 119/P308	430	1.577,60	FG 119/R558	430	1.510,40	FG 119/R683	430	1.382,40
FG 119/P202	430	1.295,20	FG 119/P309	430	1.577,60	FG 119/R559	430	1.562,40	FG 119/R684	430	1.433,60
FG 119/P203	430	1.446,40	FG 119/P310	430	1.694,40	FG 119/R560	430	1.709,60	FG 119/R685	430	1.433,60
FG 119/P204	430	1.446,40	FG 119/P311	430	1.694,40	FG 119/R561	430	1.760,80	FG 119/R686	430	1.632,80
FG 119/P205	430	1.446,40	FG 119/P321	430	1.380,80	FG 119/R571	430	709,60	FG 119/R687	430	1.632,80
FG 119/P206	430	1.446,40	FG 119/P322	430	1.380,80	FG 119/R572	430	709,60	FG 119/R688	430	1.812,00
FG 119/P207	430	1.597,60	FG 119/P323	430	1.577,60	FG 119/R573	430	761,60	FG 119/R689	430	1.812,00
FG 119/P208	430	1.597,60	FG 119/P324	430	1.577,60	FG 119/R574	430	837,60	FG 119/R699	430	815,20
FG 119/P209	430	1.199,20	FG 119/P325	430	1.707,20	FG 119/R575	430	966,40	FG 119/R700	430	994,40
FG 119/P210	430	1.199,20	FG 119/P326	430	1.707,20	FG 119/R576	430	1.095,20	FG 119/R701	430	1.046,40
FG 119/P211	430	1.220,00	FG 119/P327	430	1.380,80	FG 119/R577	430	1.095,20	FG 119/R702	430	1.046,40
FG 119/P212	430	1.220,00	FG 119/P328	430	1.577,60	FG 119/R578	430	1.280,00	FG 119/R703	430	1.046,40
FG 119/P213	430	1.376,00	FG 119/P329	430	1.577,60	FG 119/R579	430	1.305,60	FG 119/R704	430	1.036,80
FG 119/P214	430	1.376,00	FG 119/P330	430	1.707,20	FG 119/R580	430	1.510,40	FG 119/R705	430	1.036,80
FG 119/P215	430	1.524,80	FG 119/P331	430	1.707,20	FG 119/R581	430	1.562,40	FG 119/R706	430	1.088,00
FG 119/P216	430	1.524,80	FG 119/P341	430	677,60	FG 119/R582	430	1.709,60	FG 119/R707	430	1.433,60
FG 119/P226	430	659,20	FG 119/P342	430	734,40	FG 119/R583	430	1.760,80	FG 119/R708	430	1.510,40
FG 119/P227	430	988,00	FG 119/P343	430	786,40	FG 119/R593	430	709,60	FG 119/R709	430	1.632,80
FG 119/P228	430	1.072,80	FG 119/P344	430	992,00	FG 119/R594	430	709,60	FG 119/R710	430	1.709,60
FG 119/P229	430	988,00	FG 119/P345	430	1.069,60	FG 119/R595	430	761,60	FG 119/R711	430	1.831,20
FG 119/P230	430	1.072,80	FG 119/P346	430	992,00	FG 119/R596	430	837,60	FG 119/R712	430	1.959,20
FG 119/P231	430	1.179,20	FG 119/P347	430	1.069,60	FG 119/R597	430	966,40	FG 119/R713	430	1.510,40
FG 119/P232	430	1.179,20	FG 119/P348	430	1.286,40	FG 119/R598	430	1.091,20	FG 119/R714	430	1.632,80
FG 119/P233	430	1.295,20	FG 119/P349	430	1.286,40	FG 119/R599	430	1.133,60	FG 119/R715	430	1.709,60
FG 119/P234	430	1.295,20	FG 119/P350	430	1.390,40	FG 119/R600	430	1.305,60	FG 119/R716	430	1.831,20
FG 119/P235	430	1.446,40	FG 119/P351	430	1.399,20	FG 119/R601	430	1.382,40	FG 119/R717	430	1.959,20
FG 119/P236	430	1.446,40	FG 119/P352	430	1.308,00	FG 119/R602	430	1.510,40	FG 119/R727	430	1.433,60
FG 119/P237	430	1.446,40	FG 119/P353	430	1.321,60	FG 119/R603	430	1.562,40	FG 119/R728	430	1.510,40
FG 119/P238	430	1.446,40	FG 119/P354	430	1.439,20	FG 119/R604	430	1.510,40	FG 119/R729	430	1.632,80
FG 119/P239	430	1.597,60	FG 119/P355	430	1.452,00	FG 119/R605	430	1.562,40	FG 119/R730	430	1.709,60
FG 119/P240	430	1.597,60	FG 119/P356	430	1.633,60	FG 119/R606	430	1.709,60	FG 119/R731	430	1.831,20
FG 119/P250	430	857,60	FG 119/P366	430	1.185,60	FG 119/R607	430	1.760,80	FG 119/R732	430	1.959,20
FG 119/P251	430	1.179,20	FG 119/P367	430	1.306,40	FG 119/R608	430	1.095,20	FG 119/R733	430	1.510,40
FG 119/P252	430	1.295,20	FG 119/P368	430	1.401,60	FG 119/R609	430	1.156,80	FG 119/R734	430	1.632,80
FG 119/P253	430	1.295,20	FG 119/P369	430	1.401,60	FG 119/R610	430	1.280,00	FG 119/R735	430	1.709,60
FG 119/P254	430	1.446,40	FG 119/P370	430	1.666,40	FG 119/R611	430	1.305,60	FG 119/R736	430	1.831,20
FG 119/P255	430	1.446,40	FG 119/P371	430	1.666,40	FG 119/R612	430	1.510,40	FG 119/R737	430	1.959,20
FG 119/P256	430	1.446,40	FG 119/P372	430	1.769,60	FG 119/R613	430	1.562,40	FG 119/R747	430	639,20
FG 119/P257	430	1.446,40	FG 119/P373	430	1.769,60	FG 119/R614	430	1.709,60	FG 119/R748	430	639,20
FG 119/P258	430	1.597,60	FG 119/P383	430	699,20	FG 119/R615	430	1.760,80	FG 119/R749	430	709,60
FG 119/P259	430	1.597,60	FG 119/P384	430	741,60	FG 119/R625	430	709,60	FG 119/R750	430	888,80
FG 119/P269	430	801,60	FG 119/P385	430	908,80	FG 119/R627	430	804,80	FG 119/R751	430	1.043,20
FG 119/P270	430	928,80	FG 119/P386	430	984,80	FG 119/R628	430	887,20	FG 119/R752	430	966,40
FG 119/P271	430	980,80	FG 119/P387	430	1.143,20	FG 119/R629	430	954,40	FG 119/R753	430	1.094,40
FG 119/P272	430	1.029,60	FG 119/P388	430	745,60	FG 119/R630	430	1.020,00	FG 119/R754	430	1.382,40
FG 119/P273	430	1.183,20	FG 119/R523	430	639,20	FG 119/R631	430	1.091,20	FG 119/R755	430	1.382,40
FG 119/P274	430	1.337,60	FG 119/R524	430	735,20	FG 119/R632	430	1.133,60	FG 119/R756	430	1.433,60
FG 119/P275	430	1.337,60	FG 119/R525	430	735,20	FG 119/R633	430	1.305,60	FG 119/R757	430	1.442,40
FG 119/P276	430	1.183,20	FG 119/R526	430	837,60	FG 119/R634	430	1.382,40	FG 119/R758	430	1.404,80
FG 119/P277	430	1.337,60	FG 119/R527	430	837,60	FG 119/R635	430	1.510,40	FG 119/R759	430	1.417,60
FG 119/P278	430	1.337,60	FG 119/R528	430	837,60	FG 119/R636	430	1.510,40	FG 119/R760	430	1.482,40

CODE	PAGE	€/Pz	CODE	PAGE	€/Pz	CODE	PAGE	€/Pz	CODE	PAGE	€/Pz
FG 119/R761	430	1.495,20	FG 128/CA8	127	14,60	FG 131/PL	263	56,00	FG 135/50	125	33,00
FG 119/R762	430	1.784,00	FG 128/S20	126	12,80	FG 131/PL9R	263	56,00	FG 135/60	125	45,00
FG 119/R772	430	1.305,60	FG 128/S20B	126	14,00	FG 131/PL12R	263	62,00	FG 136/30	125	48,00
FG 119/R773	430	1.433,60	FG 128/U5	126	7,50	FG 131/PL9	263	112,00	FG 136/40	125	58,00
FG 119/R774	430	1.690,40	FG 129/C2	127	7,00	FG 131/PL12	263	118,00	FG 136/50	125	68,00
FG 119/R775	430	1.690,40	FG 129/C3	127	7,00	FG 131/SC	263	58,00	FG 136/R30	125	8,50
FG 119/R776	430	2.145,60	FG 129/C4	127	7,50	FG 131/SCG	263	108,00	FG 136/R40	125	10,50
FG 119/R777	430	2.145,60	FG 129/C5	127	7,50	FG 131/SCP	263	88,00	FG 136/R50	125	16,00
FG 119/R778	430	2.472,00	FG 129/C6	127	8,60	FG 131/SCZ	263	50,00	FG 136/L22	124	18,50
FG 119/R779	430	2.472,00	FG 129/C8	127	9,20	FG 131/TB	263	42,00	FG 136/L28	124	23,00
FG 119/R789	430	709,60	FG 129/C10	127	10,80	FG 131/TC	263	46,00	FG 136/L35	124	31,00
FG 119/R790	430	633,60	FG 129C/S6	127	52,00	FG 131/TR	263	46,00	FG 136/L42	124	48,00
FG 119/R791	430	867,20	FG 129/P1	127	6,90	FG 131/TV	263	46,00	FG 136/L50	124	65,00
FG 119/R792	430	909,60	FG 129/P2	127	6,90	FG 132/E200	124	15,00	FG 136/L60	124	70,00
FG 119/R793	430	998,40	FG 129/P3	127	7,80	FG 132/H200	124	14,00	FG 136/L22-M	124	5,20
FG 119/R794	430	475,20	FG 129/P4	127	7,80	FG 132/H300	124	16,00	FG 136/L28-M	124	5,20
FG 121/B100	278	275,00	FG 129/P5	127	7,80	FG 132/H500	124	20,00	FG 136/L35-M	124	6,00
FG 121/B125	278	365,00	FG 129/P6	127	7,80	FG 132/H800	124	26,00	FG 136/L42-M	124	6,20
FG 121/B150	278	465,00	FG 129P/S6	127	46,50	FG 132/H1000	124	28,00	FG 136/L50-M	124	7,20
FG 121/B175	278	700,00	FG 129/S125	127	12,50	FG 132/H1500	124	35,50	FG 136/L60-M	124	8,00
FG 125/A1	278	14,00	FG 129/S150	127	15,00	FG 132/H200-M	124	5,50	FG 136L/R22	124	3,00
FG 125/A2	278	20,00	FG 129/S170	127	18,50	FG 132/H300-M	124	6,20	FG 136L/R28	124	4,00
FG 125/A3	278	24,50	FG 128/S11	127	116,00	FG 132/H500-M	124	7,30	FG 136L/R35	124	4,50
FG 125/S3	278	65,00	FG 129/S20	126	11,80	FG 132/H800-M	124	8,40	FG 136L/R42	124	6,50
FG 125/B400	193	25,00	FG 128/BR2	360	1.500,00	FG 132/H1000-M	124	8,80	FG 136L/R50	124	14,50
FG 125/L500	278	21,00	FG 128/GR2	360	1.500,00	FG 132/H1500-M	124	9,50	FG 136L/R60	124	15,30
FG 125/L700	278	27,00	FG 128/RR2	360	1.500,00	FG 132/200	124	17,70	FG 137/TRX7	84	4,50
FG 126/A300	195	18,00	FG 128/2	350	700,00	FG 132/300	124	19,50	FG 137/TRX8	84	4,50
FG 126/A500	195	33,00	FG 128/B2	350	950,00	FG 132/500	124	20,50	FG 137/TRX9	84	4,50
FG 126/A600	195	42,00	FG 128/D2	350	950,00	FG 132/800	124	26,00	FG 137/TRX10	84	4,50
FG 126/P500	195	45,00	FG 128/R2	350	950,00	FG 132/1000	124	28,50	FG 137/TRX15	84	4,60
FG 126/VP	195	21,50	FG 129/1	352	550,00	FG 132/1000	124	28,50	FG 137/TRX15	84	4,60
FG 126/SL1	126	7,00	FG 129/1.5	353	650,00	FG 132/B2	355	2.350,00	FG 137/TRX20	84	4,60
FG 126/SL2	126	7,80	FG 129/2	351	850,00	FG 132/D2	355	2.350,00	FG 137/TRX25	84	4,70
FG 126/SN1	125	11,70	FG 129/B1	352	690,00	FG 132/R2	355	2.350,00	FG 137/TRX27	84	4,80
FG 126/SN2	125	14,00	FG 129/D1	352	690,00	FG 132/FB2	359	2.400,00	FG 137/TRX30	84	5,20
FG 126/SN3	125	22,50	FG 129/R1	352	690,00	FG 132/FD2	359	2.400,00	FG 137/TRX40	84	5,90
FG 126/SN4	125	31,50	FG 129/B1.5	353	790,00	FG 132/FR2	359	2.400,00	FG 137/TRX45	84	5,90
FG 126/SN5	125	42,50	FG 129/D1.5	353	790,00	FG 133/B2	356	2.300,00	FG 137/TRX50	84	6,60
FG 126/SN4S	125	40,50	FG 129/R1.5	353	790,00	FG 133/D2	356	2.300,00	FG 137	84	55,00
FG 126/SN5S	125	52,00	FG 129/B2	351	1.100,00	FG 133/R2	356	2.300,00	FG 138/TX7	83	4,00
FG 126SH/SN4	125	9,00	FG 129/D2	351	1.100,00	FG 134/B2	357	3.000,00	FG 138/TX8	83	4,00
FG 126SH/SN5	125	9,00	FG 129/R2	351	1.100,00	FG 134/D2	357	3.000,00	FG 138/TX9	83	4,00
FG 127/BE1	125	8,30	FG 129/BR1	361	160,00	FG 134/R2	357	3.000,00	FG 138/TX10	83	4,10
FG 127/BE2	125	8,30	FG 129/GR1	361	160,00	FG 135/B2	357	3.600,00	FG 138/TX15	83	4,10
FG 127/BE3	125	8,80	FG 129/RR1	361	160,00	FG 135/D2	357	3.600,00	FG 138/TX20	83	4,10
FG 127/BE4	125	13,00	FG 129/BR1.5	361	225,00	FG 135/R2	357	3.600,00	FG 138/TX25	83	4,30
FG 127/BE6	125	19,50	FG 129/GR1.5	361	225,00	FG 136/B1.5	363	1.250,00	FG 138/TX27	83	4,40
FG 127/BE7	125	20,00	FG 129/RR1.5	361	225,00	FG 136/D1.5	363	1.250,00	FG 138/TX30	83	5,00
FG 127/BE6S	125	26,50	FG 129/LB2	358	980,00	FG 136/R1.5	363	1.250,00	FG 138/TX40	83	5,40
FG 127/BE7S	125	27,00	FG 129/LD2	358	980,00	FG 137/B1.5	363	1.400,00	FG 138/TX45	83	7,50
FG 127/BE8S	125	29,00	FG 129/LR2	358	980,00	FG 137/D1.5	363	1.400,00	FG 138/TX50	83	7,90
FG 127SH/BE5-8	125	8,00	FG GA/80	361	1,00	FG 137/R1.5	363	1.400,00	FG 138	83	55,00
FG 127/P1	125	17,00	FG GA/120	361	1,20	FG 133/H340	124	24,60	FG 138/B	83	34,00
FG 127/P1S	125	27,00	FG GA/T	361	1,30	FG 133/H540	124	30,20	FG 138/BP	83	68,00
FG 127SH/P1	125	10,00	FG 130/A1	364	1.220,00	FG 133/H910	124	36,00	FG 138BP/TX8	83	4,60
FG 127/PU1	126	11,00	FG 130/D1	364	850,00	FG 134/H800	124	21,00	FG 138BP/TX9	83	4,60
FG 127/PU2	126	13,00	FG 130AL/S5	264	35,00	FG 134/H1000	124	22,20	FG 138BP/TX10	83	4,70
FG 127/PU2S	126	20,00	FG 130/S10	264	580,00	FG 134/H1250	124	25,20	FG 138BP/TX15	83	4,70
FG 127SH/PU2	126	7,00	FG 130/TP	263	38,00	FG 134/H1500	124	28,50	FG 138BP/TX20	83	4,80
FG 127/S1	126	48,00	FG 130/TPP	263	40,00	FG 134/H2000	124	34,50	FG 138BP/TX25	83	4,90
FG 128/BU	126	25,00	FG 130/TQ	263	44,00	FG 134/H800-M	124	6,50	FG 138BP/TX27	83	5,00
FG 128/BU2	126	8,00	FG 130/TZQ	263	46,00	FG 134/H1000-M	124	6,50	FG 138BP/TX30	83	5,30
FG 128C/S6	126	45,00	FG 131/A1	364	1.350,00	FG 134/H1250-M	124	7,00	FG 138BP/TX40	83	6,00
FG 128P/S6	126	40,00	FG 131/D1	364	1.000,00	FG 134/H1500-M	124	7,00	FG 138BP/TX45	83	8,10
FG 128/CA2	127	8,20	FG 131/B2	354	1.700,00	FG 134/H2000-M	124	7,80	FG 138BP/TX50	83	8,60
FG 128/CA3	127	8,20	FG 131/D2	354	1.700,00	FG 134/R300	124	33,00	FG 138/C	83	37,00
FG 128/CA4	127	9,30	FG 131/R2	354	1.700,00	FG 134/R500	124	52,00	FG 138C/FS	83	30,00
FG 128/CA5	127	10,00	FG 131/FB2	359	1.800,00	FG 134/R800	124	78,00	FG 138/M	83	58,00
FG 128/CA6	127	13,40	FG 131/FD2	359	1.800,00	FG 134/R1000	124	95,00	FG 138/S9	83	25,00
FG 128/CA7	127	13,40	FG 131/FR2	359	1.800,00	FG 135/35	125	24,50	FG 139	82	36,00
						FG 135/45	125	32,00	FG 139/1.5	82	1,40

CODE	PAGE	€/Pz	CODE	PAGE	€/Pz	CODE	PAGE	€/Pz	CODE	PAGE	€/Pz
FG 139/2	82	1,50	FG 139/D11	84	4,40	FG 142/10	84	18,00	FG 149/TX10	42	10,50
FG 139/2.5	82	1,50	FG 139/D12	84	5,00	FG 142/S9	84	125,00	FG 149/TX15	42	10,50
FG 139/3	82	1,50	FG 139/D13	84	6,50	FG 143/TX7	84	10,20	FG 149/TX20	42	10,50
FG 139/4	82	1,70	FG 139/D14	84	7,20	FG 143/TX8	84	10,20	FG 149/TX25	42	10,50
FG 139/4.5	82	2,00	FG 139/D16	84	11,00	FG 143/TX9	84	10,20	FG 149/TX27	42	10,50
FG 139/5	82	2,00	FG 139/D17	84	11,50	FG 143/TX10	84	10,50	FG 149/TX30	42	10,50
FG 139/5.5	82	2,80	FG 139/D19	84	15,50	FG 143/TX15	84	11,00	FG 149/TX40	42	10,50
FG 139/6	82	2,80	FG 139/D22	84	23,50	FG 143/TX20	84	11,80	FG 149TX/S8	42	90,00
FG 139/7	82	3,80	FG 139/D24	84	30,00	FG 143/TX25	84	12,60	FG 149TX/S8B	42	95,00
FG 139/8	82	4,90	FG 139/D27	84	41,50	FG 143/TX27	84	13,20	FG 149E/H4	102	18,00
FG 139/10	82	5,80	FG 139/D30	84	52,50	FG 143/TX30	84	13,90	FG 149E/H5	102	18,20
FG 139C/FS	82	24,00	FG 139/D32	84	74,00	FG 143/TX40	84	15,80	FG 149E/H6	102	18,50
FG 139/B1.5	81	0,40	FG 139/D36	84	105,00	FG 143/TX45	84	18,50	FG 149E/H8	102	21,50
FG 139/B2	81	0,40	FG 139/E	84	32,00	FG 143/TX50	84	21,50	FG 149E/S4	103	88,00
FG 139/B2.5	81	0,50	FG 139/E1.5	84	1,40	FG 143TX/S6	84	80,00	FG 150/H2	56	12,00
FG 139/B3	81	0,50	FG 139/E2	84	1,40	FG 143TX/S12	84	165,00	FG 150/H2,5	56	12,00
FG 139/B4	81	0,60	FG 139/E2.5	84	1,60	FG 147/H2.5	34	6,00	FG 150/H3	56	12,00
FG 139/B4.5	81	0,60	FG 139/E3	84	1,60	FG 147/H3	34	6,00	FG 150/H4	56	12,00
FG 139/B5	81	0,70	FG 139/E4	84	1,80	FG 147/H4	34	6,00	FG 150/H5	56	12,00
FG 139/B5.5	81	0,70	FG 139/E5	84	2,20	FG 147/H5	34	6,00	FG 150/H6	56	12,00
FG 139/B6	81	1,30	FG 139/E5.5	84	2,40	FG 147/H6	34	6,00	FG 150/H8	56	12,00
FG 139/B7	81	1,60	FG 139/E6	84	2,40	FG 147/H7	34	6,00	FG 150/H10	56	12,00
FG 139/B8	81	1,70	FG 139/E7	84	2,60	FG 147/H8	34	6,00	FG 150/H12	56	14,50
FG 139/B9	81	2,10	FG 139/E8	84	3,20	FG 147/H10	34	6,00	FG 150/H14	56	14,50
FG 139/B10	81	2,60	FG 139/E10	84	4,90	FG 147H/S8	34	58,00	FG 150/H17	56	16,00
FG 139/B11	81	3,80	FG 139/E12	84	6,50	FG 147/PH1	34	6,00	FG 150/H19	56	17,50
FG 139/B12	81	5,50	FG 139/E14	84	9,20	FG 147/PH2	34	6,00	FG 150H/S9	56	115,00
FG 139/B13	81	5,60	FG 139/E17	84	15,50	FG 147/PH3	34	6,00	FG 150H/S12	56	135,00
FG 139/B14	81	8,00	FG 139/E19	84	21,50	FG 147/PH4	34	6,00	FG 150H/S30	56	200,00
FG 139/B16	81	9,00	FG 139/LM	81	50,00	FG 147/PT10	34	9,20	FG 150/M5	53	13,00
FG 139/B17	81	12,50	FG 139FS/IN	83	24,00	FG 147/PT15	34	9,20	FG 150/M6	53	13,00
FG 139/B19	81	17,50	FG 139IN/0.05	83	0,90	FG 147/PT20	34	9,20	FG 150/M8	53	13,00
FG 139/B22	81	27,00	FG 139IN5/64	83	1,10	FG 147/PT25	34	9,20	FG 150/M9	53	13,00
FG 139/B24	81	32,00	FG 139IN3/32	83	1,20	FG 147/PT27	34	9,20	FG 150/M10	53	13,00
FG 139/B27	81	42,00	FG 139IN7/64	83	1,30	FG 147/PT30	34	9,20	FG 150/M12	53	13,00
FG 139/B30	81	65,00	FG 139IN1/8	83	1,30	FG 147PT/S6	34	63,00	FG 150/M14	53	13,00
FG 139/B32	81	90,00	FG 139IN9/64	83	1,50	FG 147/SL4	34	6,00	FG 150/M16	53	13,80
FG 139/B36	81	120,00	FG 139IN5/32	83	1,50	FG 147/SL5.5	34	6,00	FG 150M/S7	53	95,00
FG 139/B	81	16,00	FG 139IN1/6	83	1,60	FG 147/SL6.5	34	6,00	FG 150M/S26	53	180,00
FG 139B/S6	81	9,00	FG 139IN3/16	83	1,60	FG 147/SL8	34	6,00	FG 150/PL	349	65,00
FG 139/C1.5	81	0,80	FG 139IN7/32	83	1,80	FG 147/SL10	34	6,00	FG 150/PR	349	40,00
FG 139/C2	81	0,90	FG 139IN1/4	83	2,00	FG 147/TX9	34	8,00	FG 150/R4	54	13,00
FG 139/C2.5	81	1,00	FG 139IN5/16	83	2,50	FG 147/TX10	34	8,00	FG 150/R5	54	13,00
FG 139/C3	81	1,10	FG 139IN3/8	83	3,00	FG 147/TX15	34	8,00	FG 150/R6	54	13,00
FG 139/C4	81	1,40	FG 139/IN	83	38,00	FG 147/TX20	34	8,00	FG 150/R7	54	13,00
FG 139/C4.5	81	1,60	FG 139/L1.5	82	2,10	FG 147/TX25	34	8,00	FG 150/R8	54	13,00
FG 139/C5	81	1,60	FG 139/L2	82	2,20	FG 147/TX27	34	8,00	FG 150/R9	54	13,00
FG 139/C5.5	81	1,70	FG 139/L2.5	82	2,20	FG 147/TX30	34	8,00	FG 150/R10	54	13,00
FG 139/C6	81	2,10	FG 139/L3	82	2,30	FG 147/TX40	34	8,00	FG 150/R11	54	13,00
FG 139/C7	81	2,60	FG 139/L4	82	2,60	FG 147TX/S8	34	70,00	FG 150/R12	54	13,00
FG 139/C8	81	3,20	FG 139/L4.5	82	3,20	FG 149/H3	42	6,60	FG 150/R13	54	13,50
FG 139/C10	81	5,20	FG 139/L5	82	3,20	FG 149/H4	42	6,60	FG 150/R14	54	13,50
FG 139/C12	81	6,80	FG 139/L5.5	82	3,20	FG 149/H5	42	6,60	FG 150R/S11	54	140,00
FG 139/C14	81	9,50	FG 139/L6	82	4,00	FG 149/H6	42	6,60	FG 150/RF4	55	14,50
FG 139/C17	81	17,50	FG 139/L7	82	4,20	FG 149/H7	42	6,60	FG 150/RF5	55	14,50
FG 139/C19	81	17,80	FG 139/L8	82	4,40	FG 149/H8	42	6,60	FG 150/RF6	55	14,50
FG 139/C	81	23,00	FG 139/L10	82	6,40	FG 149/H10	42	6,60	FG 150/RF7	55	14,50
FG 139/D	84	21,00	FG 139/L12	82	8,50	FG 149H/S7	42	52,00	FG 150/RF8	55	15,00
FG 139/D1.5	84	0,70	FG 139/L14	82	13,50	FG 149/PH1	42	6,50	FG 150/RF9	55	15,00
FG 139/D2	84	0,70	FG 139/L17	82	21,50	FG 149/PH2	42	6,50	FG 150/RF10	55	15,00
FG 139/D2.5	84	0,70	FG 139/L19	82	28,00	FG 149/PH3	42	6,50	FG 150/RF11	55	15,00
FG 139/D3	84	0,90	FG 139/L	82	40,00	FG 149/PH4	42	6,50	FG 150/RF12	55	15,00
FG 139/D4	84	1,00	FG 139/S9	84	39,00	FG 149/PT40	42	9,50	FG 150/RF13	55	15,50
FG 139/D4.5	84	1,00	FG 142/2	84	9,60	FG 149/PT45	42	9,50	FG 150/RF14	55	15,50
FG 139/D5	84	1,30	FG 142/2.5	84	10,20	FG 149/PT50	42	9,50	FG 150RF/S11	55	168,00
FG 139/D5.5	84	1,50	FG 142/3	84	11,00	FG 149/SL5.5	42	6,60	FG 150/TX6	51	13,00
FG 139/D6	84	1,50	FG 142/4	84	12,20	FG 149/SL6.5	42	6,60	FG 150/TX7	51	13,00
FG 139/D7	84	2,00	FG 142/5	84	13,20	FG 149/SL8	42	6,60	FG 150/TX8	51	13,00
FG 139/D8	84	2,30	FG 142/6	84	15,00	FG 149/SL10	42	6,60	FG 150/TX9	51	13,00
FG 139/D9	84	2,80	FG 142/7	84	15,30	FG 149PF/S8	42	56,00	FG 150/TX10	51	13,00
FG 139/D10	84	3,50	FG 142/8	84	16,50	FG 149/TX9	42	10,50	FG 150/TX15	51	13,00

CODE	PAGE	€/Pz	CODE	PAGE	€/Pz	CODE	PAGE	€/Pz	CODE	PAGE	€/Pz
FG 150/TX20	51	13,00	FG 150L/M14	53	15,50	FG 152/RM9	57	12,00	FG 161/OS5	148	625,00
FG 150/TX25	51	13,00	FG 150LM/S7	53	112,00	FG 152/RM10	57	12,00	FG 162/1	144	90,00
FG 150/TX27	51	13,00	FG 150XL/M5	53	18,50	FG 152/RM12	57	13,50	FG 162/2	144	95,00
FG 150/TX30	51	13,50	FG 150XL/M6	53	18,50	FG 152/RM12	194	13,50	FG 162/3	144	168,00
FG 150/TX40	51	13,50	FG 150XL/M8	53	18,50	FG 152/RM14	57	13,50	FG 162/4	144	195,00
FG 150/TX45	51	14,00	FG 150XL/M9	53	18,50	FG 152/RM14	194	13,50	FG 162/5	144	295,00
FG 150/TX50	51	14,00	FG 150XL/M10	53	18,50	FG 152/RM16	57	13,50	FG 162/S3	144	355,00
FG 150/TX55	51	15,50	FG 150XL/M12	53	25,50	FG 152/RM16	194	13,50	FG 162/1-G1	144	28,00
FG 150/TX60	51	16,50	FG 150XL/M14	53	28,00	FG 152/RM18	57	13,50	FG 162/2-G2	144	29,00
FG 150/TX70	51	16,50	FG 150XXL/M8	53	25,50	FG 152/RM18	194	13,50	FG 162/3-G3	144	50,00
FG 150TX/S11	51	160,00	FG 150XXL/M10	53	25,50	FG 152RM/S4	194	65,00	FG 162/4-G4	144	52,00
FG 150TX/S32	51	190,00	FG 150XXL/M12	53	33,00	FG 152RM/S9	57	125,00	FG 162/5-G5	144	70,00
FG 150E/H4	100	26,00	FG 150XXL/M14	53	37,00	FG 152L/RM9	189	22,00	FG 162/1-V1	144	26,00
FG 150E/H5	100	26,00	FG 150L/R4	54	14,50	FG 152/RTX20	57	14,50	FG 162/2-V2	144	26,00
FG 150E/H6	100	26,00	FG 150L/R5	54	14,50	FG 152/RTX25	57	14,50	FG 162/3-V3	144	32,00
FG 150E/H8	100	26,00	FG 150L/R6	54	14,50	FG 152/RTX27	57	14,50	FG 162/4-V4	144	32,00
FG 150E/H10	100	27,00	FG 150L/R7	54	14,50	FG 152/RTX30	57	14,50	FG 162/5-V5	144	42,00
FG 150E/S4	101	115,00	FG 150L/R8	54	14,50	FG 152/RTX40	57	14,50	FG 168/EF1	144	310,00
FG 150E/LH4	100	31,50	FG 150L/R9	54	14,50	FG 152/RTX45	57	15,50	FG 168/EF2	144	320,00
FG 150E/LH5	100	31,50	FG 150L/R10	54	14,50	FG 152/RTX50	57	16,50	FG 168/EF1-G1	144	110,00
FG 150E/LH6	100	31,50	FG 150L/R11	54	14,50	FG 152/RTX55	57	16,50	FG 168/EF2-G2	144	115,00
FG 150E/LH8	100	31,50	FG 150L/R12	54	14,50	FG 152/RTX60	57	16,50	FG 168/EF1-V1	144	52,00
FG 150E/LH10	100	34,00	FG 150L/R13	54	14,50	FG 152/RTX70	57	16,50	FG 168/EF2-V2	144	62,00
FG 150/AR	322	100,00	FG 150L/R14	54	14,50	FG 152/RTXS10	57	165,00	FG 162/MA1	148	320,00
FG 150D/5G	322	1.000,00	FG 150L/RF4	55	15,00	FG 159/PM	197	220,00	FG 162/MA3	148	510,00
FG 150R/5G	322	1.000,00	FG 150L/RF5	55	15,00	FG 159/S5	197	55,00	FG 162/FR1	145	145,00
FG 150D/6G	322	1.050,00	FG 150L/RF6	55	15,00	FG 160B/14L	323	3.550,00	FG 162/FR2	145	190,00
FG 150R/6G	322	1.050,00	FG 150L/RF7	55	15,00	FG 160D/14L	323	3.550,00	FG 162/FR3	145	230,00
FG 150D/7G	322	1.100,00	FG 150L/RF8	55	15,50	FG 160R/14L	323	3.550,00	FG 162/ME	144	32,50
FG 150R/7G	322	1.100,00	FG 150L/RF9	55	15,50	FG 160V/14L	323	3.550,00	FG 163/1	145	195,00
FG 150L/H2	56	12,50	FG 150L/RF10	55	15,50	FG 160/1	144	105,00	FG 163/3	145	270,00
FG 150L/H2,5	56	12,50	FG 150L/RF11	55	16,00	FG 160/2	144	235,00	FG 163/1-GR1	145	24,00
FG 150L/H3	56	12,50	FG 150L/RF12	55	16,00	FG 160/3	144	420,00	FG 163/3-GR3	145	33,00
FG 150L/H4	56	12,50	FG 150L/RF13	55	16,00	FG 160/GL1	147	85,00	FG 163/1-V1	145	29,50
FG 150L/H5	56	12,50	FG 150L/RF14	55	16,50	FG 160/GL2	147	105,00	FG 163/3-V3	145	38,50
FG 150L/H6	56	12,50	FG 150L/TX20	51	15,50	FG 160/GL3	147	160,00	FG 163/S2B	145	255,00
FG 150L/H8	56	12,50	FG 150L/TX25	51	15,50	FG 160/GL4	147	185,00	FG 164/A	195	130,00
FG 150L/H10	56	12,50	FG 150L/TX27	51	15,50	FG 160/GL1-G1	147	17,00	FG 164/C	195	240,00
FG 150L/H11	56	15,00	FG 150L/TX30	51	15,50	FG 160/GL2-G2	147	17,00	FG 164/D	195	246,00
FG 150L/H12	56	16,50	FG 150L/TX40	51	15,50	FG 160/GL3-G3	147	30,00	FG 164/E	195	260,00
FG 150L/H13	56	16,50	FG 150L/TX45	51	15,80	FG 160/GL4-G4	147	39,00	FG 164/S3	195	250,00
FG 150L/H5B	57	14,00	FG 150L/TX50	51	15,80	FG 160/GL1-V1	147	22,00	FG 164/S3B	195	165,00
FG 150L/H6B	57	14,00	FG 150L/TX55	51	16,80	FG 160/GL2-V2	147	35,00	FG 164/S10	195	175,00
FG 150L/H7B	57	14,00	FG 150L/TX60	51	16,80	FG 160/GL3-V3	147	49,00	FG 164/1	145	190,00
FG 150L/H8B	57	14,00	FG 150L/TX70	51	18,50	FG 160/GL4-V4	147	50,00	FG 164/2	145	235,00
FG 150L/H10B	57	14,00	FG 150LTX/S6	51	102,00	FG 160/OS1	148	92,00	FG 164/1-GR1	145	20,00
FG 150XL/H5	56	16,50	FG 150XL/TX40	51	18,50	FG 160/OS2	148	135,00	FG 164/2-GR2	145	25,00
FG 150XL/H6	56	16,50	FG 150XL/TX45	51	18,50	FG 160/OS3	148	205,00	FG 165/BC1	271	45,00
FG 150XL/H7	56	16,50	FG 150XL/TX50	51	18,50	FG 160/OS4	148	225,00	FG 165/BC2	271	42,00
FG 150XL/H8	56	16,50	FG 150XL/TX55	51	18,50	FG 160/OS5	148	390,00	FG 165/FC	193	48,00
FG 150XL/H10	56	16,50	FG 150XL/TX60	51	25,00	FG 160/OS1-G1	148	17,00	FG 165/1	146	290,00
FG 150XL/H12	56	17,00	FG 150XL/TX70	51	28,00	FG 160/OS2-G2	148	30,00	FG 165/2	146	360,00
FG 150XL/H14	56	17,00	FG 150XXL/TX40	51	25,50	FG 160/OS3-G3	148	44,00	FG 165/3	146	540,00
FG 150XXL/H5	56	25,00	FG 150XXL/TX45	51	25,50	FG 160/OS4-G4	148	46,00	FG 165/1-G1	146	33,00
FG 150XXL/H6	56	25,00	FG 150XXL/TX50	51	25,50	FG 160/OS5-G5	148	92,00	FG 165/2-G2	146	44,00
FG 150XXL/H7	56	25,00	FG 150XXL/TX55	51	25,50	FG 160/OS1-V1	148	24,00	FG 165/3-G3	146	64,00
FG 150XXL/H8	56	25,00	FG 150XXL/TX60	51	32,80	FG 160/OS2-V2	148	38,00	FG 165/Hi-G1	146	64,00
FG 150XXL/H10	56	26,00	FG 150XXL/TX70	51	36,50	FG 160/OS3-V3	148	56,00	FG 165/1-V1	146	25,00
FG 150XXL/H12	56	30,00	FG 152/RH5	57	12,00	FG 160/OS4-V4	148	70,00	FG 165/2-V2	146	38,00
FG 150XXL/H5B	57	19,50	FG 152/RH6	57	12,00	FG 160/OS5-V5	148	85,00	FG 165/3-V3	146	52,00
FG 150XXL/H6B	57	19,50	FG 152/RH7	57	12,00	FG 161/1	144	120,00	FG 165/Hi	146	950,00
FG 150XXL/H7B	57	19,50	FG 152/RH8	57	12,00	FG 161/2	144	250,00	FG 165/Hi-V1	146	360,00
FG 150XXL/H8B	57	19,50	FG 152/RH10	57	12,00	FG 161/3	144	460,00	FG 165/IE1	147	310,00
FG 150XXL/H10B	57	19,50	FG 152/RH12	57	12,00	FG 161/GL1	147	105,00	FG 165/IE2	147	740,00
FG 150H/S10B	57	165,00	FG 152/RH14	57	14,00	FG 161/GL2	147	130,00	FG 165/MB1	147	165,00
FG 150L/M5	53	15,50	FG 152/RH17	57	14,00	FG 161/GL3	147	200,00	FG 165/MB2	147	320,00
FG 150L/M6	53	15,50	FG 152/RH19	57	14,00	FG 161/GL4	147	240,00	FG 165/GO1	197	180,00
FG 150L/M8	53	15,50	FG 152RH/S9	57	125,00	FG 161/OS1	148	140,00	FG 165/GO2	197	150,00
FG 150L/M9	53	15,50	FG 152/RM5	57	12,00	FG 161/OS2	148	210,00	FG 166/LT	196	750,00
FG 150L/M10	53	15,50	FG 152/RM6	57	12,00	FG 161/OS3	148	285,00	FG 166/LT2	196	920,00
FG 150L/M12	53	15,50	FG 152/RM8	57	12,00	FG 161/OS4	148	315,00	FG 166/BA	196	250,00

CODE	PAGE	€/Pz	CODE	PAGE	€/Pz	CODE	PAGE	€/Pz	CODE	PAGE	€/Pz
FG 166/CB	196	70,00	FG 172/TC	200	54,00	FG 175/S15	180	130,00	FG 180/B36X41	20	68,00
FG 165/S7	198	175,00	FG 172/TG	201	49,50	FG 175/S30	178	215,00	FG 180/SP6	20	122,00
FG 165/S26	198	700,00	FG 172/MJ	201	25,00	FG 175/XZN16	180	8,00	FG 180/SP9	20	212,00
FG 166/S7	198	600,00	FG 172/S4	201	48,00	FG 175/S4	181	70,00	FG 180/S17	192	590,00
FG 166/S28	198	460,00	FG 172/OT	200	54,00	FG 175/S114	180	255,00	FG 180/S6	272	200,00
FG 166/1	146	70,00	FG 172/PA	201	65,00	FG 175/M13x1.25	180	16,00	FG 180/S12	191	82,50
FG 166/2	146	130,00	FG 172/RL1	202	22,00	FG 175/M13x1.5	180	15,00	FG 180/S38	192	700,00
FG 166/3	146	220,00	FG 172/RL2	202	24,00	FG 175/M15x1.5	180	16,00	FG 180/IN1	20	11,30
FG 167/1	146	62,00	FG 174/F2	186	70,00	FG 175/M17x1.5	180	18,50	FG 180/IN2	20	12,00
FG 167/2	146	102,00	FG 174	201	38,00	FG 175/M20x1.5	180	19,50	FG 180/IN3	20	13,00
FG 167/3	146	220,00	FG 174/SC	186	115,00	FG 175/M22x1.5	180	21,50	FG 180/IN4	20	16,00
FG 167/4	146	375,00	FG 175/A8X10	180	22,00	FG 175/OP1	179	45,00	FG 180/IN5	20	17,00
FG 168/1	197	52,00	FG 175/A32	179	28,00	FG 175/OD13x1.25	180	3,50	FG 180/IN6	20	25,00
FG 168/2	197	65,00	FG 175/B1	178	8,50	FG 175/OD13x1.5	180	3,50	FG 180/IN7	20	28,50
FG 168/3	197	98,00	FG 175/B2	178	8,50	FG 175/OD15x1.5	180	3,50	FG 180/SP7IN	20	133,00
FG 168/4	197	130,00	FG 175/B3	178	8,50	FG 175/OD17x1.5	180	3,40	FG 181/A14	188	18,00
FG 168EP/S5	150	32,00	FG 175/B4	178	8,50	FG 175/OD20x1.5	180	3,40	FG 181/A16	188	19,00
FG 168/S25	150	140,00	FG 175/B5	178	8,50	FG 175/OD22x1.5	180	4,20	FG 181/A18	188	22,00
FG 168/E	197	95,00	FG 175/B6	178	8,50	FG 175/W13x1.5	180	0,50	FG 181/A21	188	24,00
FG 168/F1	147	2,90	FG 175/B7	178	8,50	FG 175/W15x1.5	180	0,50	FG 181/B14	188	16,00
FG 168/F2	147	2,90	FG 175/B8	178	8,50	FG 175/W17x1.5	180	0,60	FG 181/B16	188	17,00
FG 168/F3	147	4,00	FG 175/B9	178	8,50	FG 175/W20x1.5	180	0,80	FG 181/B18	188	19,00
FG 168/F4	147	4,60	FG 175/B10	178	9,00	FG 175/W22x1.5	180	0,90	FG 181/B21	188	22,00
FG 168/F5	147	5,10	FG 175/B11	178	9,00	FG 176/CJ	180	32,00	FG 181/C14	188	27,50
FG 168/F6	147	7,00	FG 175/B12	178	9,50	FG 176/FO1	179	85,00	FG 181/PM	203	148,00
FG 168/F7	147	13,00	FG 175/B13	178	9,50	FG 176/FO2	179	90,00	FG 181/PM2	203	90,00
FG 168/F8	147	18,00	FG 175/B14	178	9,50	FG 176/FO1-C	179	32,00	FG 181/RE1	188	38,50
FG 168/FS5	147	18,50	FG 175/B15	178	9,50	FG 176/FO2-C	179	45,00	FG 181/RE2	188	38,50
FG 168/FS8	147	60,00	FG 175/B16	178	9,50	FG 176/NA1	179	35,00	FG 181RE/S2	188	77,00
FG 168/R6	147	13,00	FG 175/B17	178	9,50	FG 176/NA2	179	40,00	FG 181/S17	188	115,00
FG 168/R7	147	13,00	FG 175/B18	178	11,50	FG 176/NA1-R	179	15,50	FG 181/S115	188	360,00
FG 168/R8	147	14,00	FG 175/B19	178	11,50	FG 176/NA2-R	179	17,50	FG 181/S130	188	275,00
FG 168/R9	147	15,00	FG 175/B20	178	11,50	FG 176/RP	179	45,00	FG 181T/A14	188	52,00
FG 168/R10	147	15,00	FG 175/B21	178	19,00	FG 176/RP2	179	48,00	FG 181T/A16	188	53,00
FG 168/R10.5	147	15,00	FG 175/C1	178	9,00	FG 176/RE	179	35,00	FG 181T/A21	188	65,00
FG 168/R12	147	15,00	FG 175/C2	178	9,00	FG 176/RE-SP	179	8,50	FG 181/S3	188	170,00
FG 168/R14	147	21,00	FG 175/C3	178	9,00	FG 176/S13	182	445,00	FG 182/EG1	146	77,00
FG 168/R16	147	22,00	FG 175/C4	178	9,50	FG 177/FO1	179	82,50	FG 182/EG2	146	118,00
FG 168/S9	147	175,00	FG 175/C5	178	9,50	FG 177/FO1-C	179	40,00	FG 182/ES1	146	47,00
FG 168/SD1	147	18,00	FG 175/C6	178	9,50	FG 178/3L	180	30,00	FG 182/ES2	146	58,00
FG 168/SD2	147	24,00	FG 175/S6	178	60,00	FG 178/SD	180	135,00	FG 182/ES3	146	60,00
FG 168/SD3	147	33,00	FG 175/FG2	187	90,00	FG 178/UF	181	60,00	FG 182/ES4	146	62,00
FG 168/SD4	147	45,00	FG 175/FG3	187	19,00	FG 178/20L	181	95,00	FG 182/ES5	146	95,00
FG 168SD/S4	147	150,00	FG 175/FO8	179	38,00	FG 178/BF	192	255,00	FG 182/ES6	146	98,00
FG 169/1	197	60,00	FG 175/FO10	179	49,00	FG 178/SF	192	1.760,00	FG 182/ES7	146	118,00
FG 169/2	197	78,00	FG 175/FO14	179	51,00	FG 178SF/AD13	192	55,00	FG 182/MI	146	78,00
FG 169/3	197	140,00	FG 175/FO14M	179	34,00	FG 178SF/AD14	192	55,00	FG 182/S5	146	460,00
FG 169/A44	197	55,00	FG 175/FO14T	179	29,00	FG 178/S6	192	330,00	FG 182/S10	146	850,00
FG 169/BS	197	125,00	FG 175/FO74	178	44,00	FG 179/H10	191	24,00	FG 182/S14	150	230,00
FG 169/BS1	197	115,00	FG 175/FO74.5	178	44,00	FG 179/T50	191	29,00	FG 182/S16	188	500,00
FG 169/BS3	197	115,00	FG 175/FO84	179	55,00	FG 179/GP	191	29,00	FG 72/GMC3	134	28,00
FG 169/FO1	197	43,00	FG 175/FT1	187	65,00	FG 179/H28	191	13,00	FG 182/S16-ES	188	66,00
FG 169/FO2	197	43,00	FG 175/FT2	187	80,00	FG 179/H32	191	15,00	FG 182/S16-PR	188	32,00
FG 169/FO3	197	43,00	FG 175/FT3	187	80,00	FG 179/PA20	191	15,50	FG 182/S16-PU10	188	44,00
FG 170/1	201	13,50	FG 175/FT4	187	70,00	FG 179/S16	191	155,00	FG 182/S16-PR2	188	32,00
FG 170/2	201	15,50	FG 175/FT5	187	70,00	FG 178/P1	182	85,00	FG 182/S16-GU	188	3,20
FG 170/3	201	17,50	FG 175/HI	179	65,00	FG 178/P2	182	110,00	FG 182/S4-5	188	4,50
FG 170/S3	201	48,00	FG 175/PF66	178	9,50	FG 180/A6x8	20	12,60	FG 182S16/S4-4	188	25,00
FG 171/B	201	40,00	FG 175/PF76-12	178	9,50	FG 180/A8x10	20	13,60	FG 182S16/S4-3	188	28,00
FG 171/FL	201	50,00	FG 175/PF76-30	178	9,50	FG 180/A9X11	20	14,90	FG 182/S16-PU7	188	44,00
FG 171/N	201	28,50	FG 175/PF86-18	178	10,50	FG 180/A10X11	20	14,90	FG 182/S16-PU9	188	44,00
FG 172/AS2	200	108,00	FG 175/PF93-36	178	10,50	FG 180/A11X13	20	16,30	FG 182/S4-1	188	55,00
FG 172/AS2-A	200	26,00	FG 175/PF93-45	178	10,50	FG 180/A12X14	20	18,40	FG 182/S16-IF14	188	8,00
FG 172/AS2-B	200	50,00	FG 175/PF96-18	178	11,00	FG 180/A13X14	20	20,50	FG 182/S16-MA14	188	9,00
FG 172/AS2-C	200	30,00	FG 175/PF108-18	178	12,00	FG 180/B14X15	20	20,50	FG 182/RG10	268	18,00
FG 172/AS2-D	200	33,00	FG 175/PF135-18	178	21,00	FG 180/B14X17	20	22,00	FG 182/RG24	268	25,00
FG 172/BL	189	27,00	FG 175PF/S4	178	72,00	FG 180/B17X19	20	23,60	FG 182/TS1	147	31,00
FG 172/CA	201	56,00	FG 175/PO	181	13,50	FG 180/B19X22	20	25,70	FG 182/TS2	147	43,00
FG 172/CL	200	48,50	FG 175/PO1	181	11,50	FG 180/B22X24	20	31,00	FG 182/TS3	147	75,00
FG 172/FA	200	70,00	FG 175/PO2	181	13,50	FG 180/B24x27	20	32,50	FG 183/B85	189	38,00
FG 172/GO2	200	105,00	FG 175/PO3	181	11,50	FG 180/B30x32	20	41,50	FG 183/B110	189	46,00

CODE	PAGE	€/Pz	CODE	PAGE	€/Pz	CODE	PAGE	€/Pz	CODE	PAGE	€/Pz
FG 183/B8	188	30,00	FG 187/W50	270	34,00	FG 192/BW8	211	420,00	FG 192/FO16B	222	210,00
FG 183/B9	188	30,00	FG 187/WT22.5	270	25,00	FG 192/BW8-1	211	119,30	FG 192/FO16C	252	290,00
FG 183/B10	188	30,00	FG 187/K10	270	23,00	FG 192/BW8-2	211	97,60	FG 192/FO24	224	280,00
FG 183/B12	188	30,00	FG 187/K25	270	42,00	FG 192/BW8-3	211	135,60	FG 192/FO24-1	224	41,90
FG 183/B14	188	30,00	FG 187/K30	270	70,00	FG 192/BW8-4	211	10,80	FG 192/FO24-2	224	9,70
FG 183/S5	188	105,00	FG 187/K40	270	190,00	FG 192/BW8-6	211	13,60	FG 192/FO24-3	224	12,90
FG 183/CM	269	50,00	FG 187K/S6	271	55,00	FG 192/BW8-7	211	21,70	FG 192/FO24-4	224	12,00
FG 183CM/S3	269	24,00	FG 187/K130	271	280,00	FG 192/BW8-8	211	16,30	FG 192/FO24-5	224	13,00
FG 183/CM19	269	8,00	FG 187/GR	269	28,00	FG 192/BW8B	213	285,00	FG 192/FO24-6	224	17,50
FG 183/CM25	269	8,00	FG 188/1	189	14,50	FG 192/BW8B-1	213	170,00	FG 192/FO24-7	224	8,30
FG 183/CM38	269	8,00	FG 188/2	189	19,50	FG 192/BW8B-2	213	15,00	FG 192/FO24-8	224	12,90
FG 183/CK250	269	21,00	FG 188/P1	265	18,00	FG 192/BW8C	213	400,00	FG 192/FO24-9	224	12,50
FG 183/CK450	269	32,00	FG 188P/S2	265	40,00	FG 192/BW8C-1	213	195,00	FG 192/FO24-10	224	6,20
FG 183/CK600	269	40,00	FG 189/PO1	268	20,00	FG 192/BW8C-2	213	106,00	FG 192/FO24-11	224	6,20
FG 183/CK-R	269	10,00	FG 189/S13	190	230,00	FG 192/BW8C-4	213	16,00	FG 192/FO24-12	224	8,10
FG 183/RA1	268	25,00	FG 190/AD1	184	52,00	FG 192/BW9	212	580,00	FG 192/FO24-13	224	8,10
FG 183RA/S10	268	12,00	FG 190/AD2	184	34,00	FG 192/BW9-1	212	297,50	FG 192/FO24-14	224	14,20
FG 183/RV1	268	20,00	FG 190/A25	185	42,00	FG 192/BW9-2	212	158,60	FG 192/FO24-15	224	3,20
FG 184/BP	203	210,00	FG 190/A27	185	42,00	FG 192/BW9-3	212	35,30	FG 192/FO24-16	224	6,40
FG 184/CP	203	75,00	FG 190/A29	185	42,00	FG 192/BW9B	209	480,00	FG 192/FO24-17	224	29,00
FG 184P/S3	264	25,00	FG 190/A30	185	42,00	FG 192/BW9B-2	209	140,00	FG 192/FO24-18	224	22,50
FG 184/R1	264	20,00	FG 190/EL	185	11,00	FG 192/BW9B-3	209	30,00	FG 192/FO24-19	224	19,30
FG 184/R2	264	22,00	FG 190/IP	184	48,00	FG 192/BW9B-4	209	120,00	FG 192/FO24-20	224	12,50
FG 184R/S3	264	45,00	FG 190/MI	185	85,00	FG 192/BW9B-6	209	5,00	FG 192/FO24-21	224	12,00
FG 184/S24	203	450,00	FG 190/MI2	185	96,00	FG 192/BW10	250	420,00	FG 192/FO24-22	224	15,00
FG 184/B13	203	28,00	FG 190/OP	184	45,00	FG 192/BW11	250	650,00	FG 192/FO24-23	224	15,00
FG 184/B15	203	28,00	FG 190/RE	185	235,00	FG 192/BW15	210	850,00	FG 192/FT1	215	36,00
FG 184/B16	203	28,00	FG 190/RI	184	56,00	FG 192/BW15A	210	35,00	FG 192/FT2	218	55,00
FG 184/B17	203	28,00	FG 190/S6B	186	165,00	FG 192/BW16	208	250,00	FG 192/FT3	215	78,00
FG 184/B19	203	28,00	FG 190/S8	185	140,00	FG 192/BW18	211	510,00	FG 192/FT4	215	85,00
FG 184/FT1	203	70,00	FG 190/SV	189	130,00	FG 192/BW19	250	835,00	FG 192/FT5	216	285,00
FG 184/S5	203	150,00	FG 190/SV2	189	400,00	FG 192/CH3	230	145,00	FG 192/FT5-1	216	140,00
FG 184/S6	203	95,00	FG 190/VW	185	92,00	FG 192/CH8	230	220,00	FG 192/FT5-2	216	44,00
FG 184TX/S5	203	170,00	FG 190/S21	186	340,00	FG 192/CH8-1	230	34,40	FG 192/FT5-3	216	41,20
FG 185/A1	265	20,00	FG 191/S22	184	600,00	FG 192/CH8-2	230	24,60	FG 192/FT5-4	216	9,20
FG 185/A2	265	20,00	FG 192/AF2	214	60,00	FG 192/CH8-3	230	29,50	FG 192/FT5A	216	20,00
FG 185/A3	265	17,00	FG 192/AF4	214	170,00	FG 192/CH8-4	230	27,00	FG 192/FT5B	216	252,00
FG 185/A4	265	18,00	FG 192/AF4-1	214	19,00	FG 192/CH8-5	230	27,00	FG 192/FT5B-1	216	70,50
FG 185/A5	266	20,00	FG 192/AF4-2	214	20,20	FG 192/CH8-7	230	14,70	FG 192/FT5B-2	216	94,90
FG 185/A6	266	16,00	FG 192/AF4-3	214	59,30	FG 192/CH8-8	230	29,50	FG 192/FT5B-5	216	33,90
FG 185/A7	266	20,00	FG 192/AF4-4	214	59,30	FG 192/CE	256	78,00	FG 192/FT5C	219	130,00
FG 185/A8	266	18,00	FG 192/AF4B	214	260,00	FG 192/CO	256	102,00	FG 192/FT5C-1	219	36,00
FG 185/S5	266	95,00	FG 192/AF4C	215	95,00	FG 192/DW2	248	102,00	FG 192/FT5C-2	219	12,00
FG 185/S190	198	150,00	FG 192/AF5	251	110,00	FG 192/FO2	252	200,00	FG 192/FT5C-3	219	45,00
FG 185/S12	190	75,00	FG 192/BW1	208	42,00	FG 192/FO3	225	52,00	FG 192/FT6	218	245,00
FG 185/S27	190	112,00	FG 192/BW2	208	55,00	FG 192/FO4	223	185,00	FG 192/FT6-1	218	35,00
FG 185B/S2	266	40,00	FG 192/BW4	208	180,00	FG 192/FO4-2	223	16,50	FG 192/FT6-2	218	81,40
FG 185/RM	268	30,00	FG 192/BW4-1	208	69,80	FG 192/FO4-3	223	78,00	FG 192/FT6-3	218	65,00
FG 185/CR	268	10,00	FG 192/BW4-2	208	58,20	FG 192/FO4-4	223	12,00	FG 192/FT6-4	218	42,00
FG 185P/S4	265	25,00	FG 192/BW4-3	208	17,50	FG 192/FO4-5	223	8,50	FG 192/FT6-5	218	11,50
FG 186/A1	267	21,00	FG 192/BW4-4	208	32,00	FG 192/FO4-7	223	22,00	FG 192/FT6A	218	125,00
FG 186/A2	267	21,00	FG 192/BW4B	209	340,00	FG 192/FO4A	223	80,00	FG 192/FT6B	219	158,00
FG 186/A3	267	17,50	FG 192/BW4C	209	140,00	FG 192/FO6	222	102,00	FG 192/FT6B-1	219	42,50
FG 186/A4	267	16,50	FG 192/BW4E	210	96,00	FG 192/FO7	224	95,00	FG 192/FT6B-2	219	55,00
FG 186/A5	267	24,00	FG 192/BW3	209	54,00	FG 192/FO7-3	224	52,50	FG 192/FT6B-4	219	6,50
FG 186/AS	271	40,00	FG 192/BW5	210	190,00	FG 192/FO7B	224	105,00	FG 192/FT6C	220	125,00
FG 186/LP	267	35,00	FG 192/BW5-1	210	56,70	FG 192/FO7C	222	110,00	FG 192/FT6C-1	220	75,00
FG 186/S5	267	95,00	FG 192/BW5-2	210	47,30	FG 192/FO7E	224	35,00	FG 192/FT6C-2	220	19,50
FG 186P/S4	195	23,00	FG 192/BW5-3	210	9,00	FG 192/FO8	225	95,00	FG 192/FT6C-3	220	13,00
FG 186P/S5	267	36,00	FG 192/BW5-4	210	11,00	FG 192/FO11	225	248,00	FG 192/FT6D	220	78,00
FG 186/S3	267	9,60	FG 192/BW5-5	210	11,00	FG 192/FO11-1	225	77,10	FG 192/FT7	217	178,00
FG 186/S3B	267	11,20	FG 192/BW5-6	210	15,80	FG 192/FO11-2	225	3,00	FG 192/FT7-1	217	17,80
FG 186/S11	265	115,00	FG 192/BW6	211	400,00	FG 192/FO11-3	225	83,10	FG 192/FT7-2	217	17,80
FG 187/GU	269	28,00	FG 192/BW6-1	211	159,40	FG 192/FO11-4	225	23,70	FG 192/FT7-3	217	5,10
FG 187/GU2	269	25,00	FG 192/BW6-4	211	153,80	FG 192/FO11-5	225	17,80	FG 192/FT7-4	217	91,50
FG 187/IM	270	40,00	FG 192/BW6-5	211	195,80	FG 192/FO11-6	225	17,80	FG 192/FT7-5	217	10,20
FG 187/IW50	270	30,00	FG 192/BW6-6	211	11,20	FG 192/FO11-7	225	23,70	FG 192/FT7-6	217	7,60
FG 187/NY	270	60,00	FG 192/BW7	212	350,00	FG 192/FO15	223	550,00	FG 192/FT8	251	165,00
FG 187/S7	271	210,00	FG 192/BW7-2	212	141,00	FG 192/FO15A	223	250,00	FG 192/FT8C	251	430,00
FG 187/PN	271	255,00	FG 192/BW7-3	212	141,00	FG 192/FO16	222	660,00	FG 192/FT10	220	145,00
FG 187/TB	271	235,00	FG 192/BW7-4	212	55,10	FG 192/FO16A	222	1.250,00	FG 192/FT10-1	220	82,00

CODE	PAGE	€/Pz	CODE	PAGE	€/Pz	CODE	PAGE	€/Pz	CODE	PAGE	€/Pz
FG 192/FT10-3	220	27,00	FG 192/MI9	228	78,00	FG 192/PS15-9	234	1,27	FG 192/VW1E	238	48,00
FG 192/FT10C	221	370,00	FG 192/MI10B	227	320,00	FG 192/PS15-10	234	9,10	FG 192/VW1F	238	95,00
FG 192/FT12	217	320,00	FG 192/MI10B-1	227	185,00	FG 192/PS15-11	234	5,19	FG 192/VW2	239	72,00
FG 192/FT12-1	217	9,50	FG 192/MI10B-2	227	110,00	FG 192/PS15-12	234	9,10	FG 192/VW3B	240	270,00
FG 192/FT12-2	217	26,00	FG 192/MI10B-3	227	8,50	FG 192/PS15-14	234	7,83	FG 192/VW4	240	142,00
FG 192/FT12-3	217	29,00	FG 192/MI10B-4	227	30,00	FG 192/PS15-15	234	98,83	FG 192/VW4-1	240	41,20
FG 192/FT12-4	217	125,00	FG 192/MI10	227	365,00	FG 192/PS15-16	234	6,46	FG 192/VW4-2	240	45,80
FG 192/FT12-5	217	15,00	FG 192/MI10-1	227	98,00	FG 192/PS15-17	234	5,19	FG 192/VW4-3	240	36,60
FG 192/FT12-6	217	99,00	FG 192/MI10-2	227	110,00	FG 192/PS15-18	234	7,80	FG 192/VW4B	239	260,00
FG 192/FT16	221	270,00	FG 192/MI10-3	227	12,00	FG 192/PS15-19	234	15,00	FG 192/VW4B-1	239	92,00
FG 192/FT17	221	650,00	FG 192/MI10-4	227	32,50	FG 192/RE3	236	115,00	FG 192/VW4B-2	239	15,00
FG 192/FT17-1	221	95,00	FG 192/MI10-5	227	3,10	FG 192/RE3-1	236	71,00	FG 192/VW4B-3	239	118,00
FG 192/FT17-2	221	56,00	FG 192/MI10-6	227	95,00	FG 192/RE3-2	236	9,70	FG 192/VW4B-4	239	18,00
FG 192/FT17-3	221	32,00	FG 192/OP1	232	16,00	FG 192/RE3-3	236	15,00	FG 192/VW4C	240	305,00
FG 192/FT17-4	221	42,00	FG 192/OP2	231	55,00	FG 192/RE4	236	245,00	FG 192/VW4C-1	240	76,00
FG 192/FT17-5	221	29,50	FG 192/OP3	232	55,00	FG 192/RE4-1	236	90,00	FG 192/VW4C-2	240	86,00
FG 192/FT17-6	221	36,50	FG 192/OP3A	232	110,00	FG 192/RE4-2	236	18,00	FG 192/VW4C-3	240	11,90
FG 192/FT17-7	221	67,00	FG 192/OP3B	232	245,00	FG 192/RE5	236	188,00	FG 192/VW4C-4	240	14,50
FG 192/FT17-8	221	67,00	FG 192/OP4	232	105,00	FG 192/RE5-2	236	56,90	FG 192/VW5	241	40,00
FG 192/FT17-9	221	12,50	FG 192/OP4B	232	355,00	FG 192/RE5-5	236	10,70	FG 192/VW5B	239	275,00
FG 192/FT17-10	221	18,00	FG 192/OP4D	232	550,00	FG 192/RE6	237	240,00	FG 192/VW5B-1	239	11,20
FG 192/FT17-11	221	12,50	FG 192/OP5	231	115,00	FG 192/RE6-2	237	13,10	FG 192/VW5B-2	239	14,00
FG 192/FT17-12	221	22,50	FG 192/OP5-1	231	67,00	FG 192/RE6-3	237	52,50	FG 192/VW5B-3	239	9,80
FG 192/FT17-13	221	29,50	FG 192/OP5-2	231	6,50	FG 192/RE6-4	237	18,40	FG 192/VW5B-4	239	291,00
FG 192/FT17-14	221	77,00	FG 192/OP5-3	231	6,50	FG 192/RE6-5	237	47,30	FG 192/VW5C	247	275,00
FG 192/FT17-15	221	10,00	FG 192/OP5-4	231	21,00	FG 192/RE6-6	237	57,80	FG 192/VW6	246	530,00
FG 192/FT17-16	221	40,00	FG 192/OP5-5	231	15,00	FG 192/RE6-7	237	2,60	FG 192/VW6-1	246	22,40
FG 192/HI1	248	95,00	FG 192/OP6	232	110,00	FG 192/RE7	237	98,00	FG 192/VW6-2	246	100,70
FG 192/HI2	248	128,00	FG 192/OP6-1	232	87,50	FG 192/RE13	237	315,00	FG 192/VW6-3	246	22,40
FG 192/HI5	248	60,00	FG 192/OP6-2	232	10,90	FG 192/RE13-1	237	65,00	FG 192/VW6-4	246	209,70
FG 192/HI7	248	195,00	FG 192/OP7	231	325,00	FG 192/RE13-2	237	42,50	FG 192/VW6-5	246	41,90
FG 192/HI7B	248	90,00	FG 192/OP7B	231	230,00	FG 192/RE13-3	237	115,00	FG 192/VW6-6	246	106,30
FG 192/HO5	248	95,00	FG 192/OP8	233	180,00	FG 192/RE13-5	237	30,00	FG 192/VW6B	246	195,00
FG 192/JE9	230	285,00	FG 192/OP9	233	360,00	FG 192/RE13-6	237	12,00	FG 192/VW6B-1	246	65,00
FG 192/JE9-1	230	120,00	FG 192/OP10	233	210,00	FG 192/RE13-7	237	9,00	FG 192/VW6B-2	246	107,00
FG 192/JE9-2	230	140,00	FG 192/OP15	233	520,00	FG 192/RE13-8	237	15,00	FG 192/VW6B-3	246	48,00
FG 192/JE9-3	230	6,00	FG 192/PM	256	82,00	FG 192/RE13A	237	135,00	FG 192/VW7	242	145,00
FG 192/JE9-4	230	65,00	FG 192/PR4	255	220,00	FG 192/TY15	249	175,00	FG 192/VW7-2	242	35,60
FG 192/JTD	219	86,00	FG 192/PR5	254	360,00	FG 192/TY45	249	610,00	FG 192/VW7-3	242	14,20
FG 192/LR2	226	55,00	FG 192/PR6	255	120,00	FG 192/TY45-1	249	2,00	FG 192/VW7-4	242	10,00
FG 192/LR6	226	275,00	FG 192/PR8	254	850,00	FG 192/TY45-2	249	64,00	FG 192/VW7-5	242	7,10
FG 192/LR8	226	315,00	FG 192/PSA	235	35,00	FG 192/TY45-3	249	42,50	FG 192/VW7B	245	185,00
FG 192/LR9	226	370,00	FG 192/PS2	235	215,00	FG 192/TY45-4	249	12,50	FG 192/VW7B-4	245	94,90
FG 192/LR11	226	820,00	FG 192/PS4	235	55,00	FG 192/TY45-5	249	15,00	FG 192/VW7B-5	245	57,60
FG 192/LR13	253	450,00	FG 192/PS5	253	270,00	FG 192/TY45-6	249	20,00	FG 192/VW7B-6	245	16,90
FG 192/LRF	252	220,00	FG 192/PS7	235	215,00	FG 192/TY45-7	249	12,50	FG 192/VW7C	241	205,00
FG 192/MB3	228	235,00	FG 192/PS7-1	235	45,00	FG 192/TY45-8	249	17,50	FG 192/VW7D	242	360,00
FG 192/MB3A	228	205,00	FG 192/PS7-2	235	53,00	FG 192/TY45-9	249	22,50	FG 192/VW7D-1	242	50,00
FG 192/MB3C	228	256,00	FG 192/PS7-3	235	5,10	FG 192/TY45-10	249	10,00	FG 192/VW7D-2	242	13,90
FG 192/MB5	229	360,00	FG 192/PS7-4	235	12,70	FG 192/TY45-11	249	20,00	FG 192/VW7D-3	242	85,00
FG 192/MB5-1	229	19,00	FG 192/PS7-5	235	6,40	FG 192/TY45-12	249	15,00	FG 192/VW7D-5	242	195,00
FG 192/MB5-2	229	129,00	FG 192/PS7-6	235	12,70	FG 192/TY45-13	249	25,00	FG 192/VW7D-6	242	11,50
FG 192/MB5-3	229	118,00	FG 192/PS7-8	235	50,00	FG 192/TY45-14	249	9,00	FG 192/VW8	241	340,00
FG 192/MB5-4	229	38,00	FG 192/PS7B	235	62,00	FG 192/TY45-15	249	9,00	FG 192/VW8-1	241	37,80
FG 192/MB5-5	229	29,00	FG 192/PS13	234	205,00	FG 192/TY45-16	249	9,00	FG 192/VW8-2	241	65,00
FG 192/MB6	230	175,00	FG 192/PS13-1	234	16,10	FG 192/TY45-17	249	9,00	FG 192/VW8-3	241	65,00
FG 192/MB6-1	230	56,00	FG 192/PS13-2	234	16,10	FG 192/TY45-18	249	4,00	FG 192/VW8-4	241	16,00
FG 192/MB6-2	230	73,00	FG 192/PS13-5	234	51,50	FG 192/TY45-19	249	106,00	FG 192/VW8-5	241	4,30
FG 192/MB6-3	230	35,00	FG 192/PS13-6	234	25,80	FG 192/TY45-20	249	2,00	FG 192/VW8-6	241	5,40
FG 192/MB10	229	160,00	FG 192/PS13-10	234	32,20	FG 192/TY45-21	249	106,00	FG 192/VW8B	241	120,00
FG 192/MB24	229	820,00	FG 192/PS13-11	234	4,80	FG 192/TY45-22	249	6,50	FG 192/VW8C	241	330,00
FG 192/MB24-1	229	220,00	FG 192/PS13-12	234	3,20	FG 192/TY45-23	249	4,50	FG 192/VW8D	241	480,00
FG 192/MB24-2	229	150,00	FG 192/PS15	234	270,00	FG 192/TY45-24	249	2,00	FG 192/VW8E	253	105,00
FG 192/MB24-3	229	250,00	FG 192/PS15-1	234	9,10	FG 192/TY45-25	249	6,50	FG 192/VW9	245	165,00
FG 192/MB24-4	229	60,00	FG 192/PS15-2	234	10,37	FG 192/TY45-26	249	55,00	FG 192/VW9-1	245	55,00
FG 192/MB24-5	229	8,00	FG 192/PS15-3	234	10,37	FG 192/VO1	247	102,00	FG 192/VW9-2	245	2,00
FG 192/MB24-6	229	15,00	FG 192/PS15-4	234	26,03	FG 192/VO3	255	230,00	FG 192/VW9-3	245	36,00
FG 192/MI6	227	210,00	FG 192/PS15-5	234	14,29	FG 192/VW1	238	55,00	FG 192/VW9-4	245	20,00
FG 192/MI6-1	227	70,20	FG 192/PS15-6	234	14,29	FG 192/VW1B	238	28,00	FG 192/VW9-5	245	13,00
FG 192/MI6-2	227	39,00	FG 192/PS15-7	234	15,00	FG 192/VW1C	238	30,00	FG 192/VW10	244	320,00
FG 192/MI6-3	227	101,40	FG 192/PS15-8	234	15,00	FG 192/VW1D	238	32,00	FG 192/VW10-2	244	38,00



CODE	PAGE	€/Pz	CODE	PAGE	€/Pz	CODE	PAGE	€/Pz	CODE	PAGE	€/Pz
FG 192/VW10-3	244	27,00	FG 193/R22	258	58,00	FG 193/UN-9	261	66,00	FG 199/A	193	52,00
FG 192/VW10-5	244	15,00	FG 193/R23	258	46,00	FG 193/UN-10	261	71,50	FG 199/FM	193	30,00
FG 192/VW10-6	244	15,00	FG 193/R24	258	28,00	FG 193/UN-11	261	66,00	FG 199/PF	193	220,00
FG 192/VW10-7	244	70,00	FG 193/R25	258	105,00	FG 193/UN-12	261	130,00	FG 199/PFP	193	22,00
FG 192/VW10-8	244	82,00	FG 193/R26	258	170,00	FG 193/DCT	262	160,00	FG 199/PM1	193	35,00
FG 192/VW10-9	244	19,00	FG 193/R27	258	135,00	FG 193/DS1	262	35,00	FG 199/PM2	193	42,00
FG 192/VW10-10	244	15,00	FG 193/R28	258	70,00	FG 193/DS2	262	35,00	FG 199/PM3	193	112,00
FG 192/VW10B	243	380,00	FG 193/R29	258	46,00	FG 193DSG/S6	262	695,00	FG 199/SF	193	60,00
FG 192/VW10B-1	243	145,00	FG 193/R30	258	128,00	FG 193DSG/S9	262	1.050,00	FG 201/CR	185	240,00
FG 192/VW10B-6	243	72,50	FG 193/R31	258	82,00	FG 194/TS	262	30,00	FG 201/S7	183	340,00
FG 192/VW11	244	1.600,00	FG 193/R32	258	128,00	FG 194/A80	273	175,00	FG 202/PV	183	220,00
FG 192/VW11-1	244	270,00	FG 193/R33	258	46,00	FG 194/A85	273	175,00	FG 203/A	183	23,00
FG 192/VW11-2	244	91,00	FG 193/R34	259	93,00	FG 194/A95	273	175,00	FG 203/BW1	183	35,00
FG 192/VW11-3	244	100,00	FG 193/R35	259	58,00	FG 194/A100	273	175,00	FG 203/FO1	183	35,00
FG 192/VW11-4	244	930,00	FG 193/R36	259	105,00	FG 194/A105	273	180,00	FG 203/FO2	183	35,00
FG 192/VW11-5	244	36,00	FG 193/R37	259	65,00	FG 194/A109	273	185,00	FG 203/OP1	183	35,00
FG 192/VW11-6	244	35,00	FG 193/R38	259	65,00	FG 194/A115	273	198,00	FG 203/TO1	183	35,00
FG 192/VW11-7	244	65,00	FG 193/R39	259	65,00	FG 194/A120	273	210,00	FG 203/S7	183	160,00
FG 192/VW11-8	244	75,00	FG 193/R40	259	65,00	FG 194/B65	273	95,00	FG 203/S20	183	370,00
FG 192/VW11-9	244	75,00	FG 193/R41	259	70,00	FG 194/B80	273	120,00	<b>FG 203</b>	<b>284</b>	<b>25,00</b>
FG 192/VW12	247	330,00	<b>FG 193/R42</b>	<b>259</b>	<b>105,00</b>	FG 194/B86	273	120,00	FG 204	284	30,00
FG 192/VW12-1	247	17,80	<b>FG 193/R44</b>	<b>259</b>	<b>105,00</b>	FG 194/B96	273	175,00	<b>FG 205</b>	<b>286</b>	<b>85,00</b>
FG 192/VW12-2	247	21,40	<b>FG 193/R45</b>	<b>259</b>	<b>105,00</b>	FG 194/B111	273	210,00	FG 213/L480	285	65,00
FG 192/VW12-3	247	14,20	<b>FG 193/R46</b>	<b>259</b>	<b>105,00</b>	FG 195/A95	273	310,00	FG 214/L600	285	85,00
FG 192/VW12-4	247	60,50	<b>FG 193/R47</b>	<b>259</b>	<b>105,00</b>	FG 195/A98	273	295,00	FG 206	282	55,00
FG 192/VW12-5	247	71,20	<b>FG 193/R48</b>	<b>259</b>	<b>105,00</b>	FG 195/A110	273	305,00	FG 207	282	65,00
FG 192/VW12-6	247	71,20	FG 193/S10	259	1.050,00	FG 195/R56	273	90,00	FG 208	282	230,00
FG 192/VW12-7	247	21,40	FG 193/S19	259	1.280,00	FG 195/R60	273	90,00	<b>FG 209</b>	<b>283</b>	<b>260,00</b>
FG 192/VW12-8	247	26,70	FG 193/AT1	260	1.350,00	FG 196/A37	273	50,00	FG 210/A	284	90,00
<b>FG 192/VW12A</b>	<b>254</b>	<b>70,00</b>	FG 193/AT1-1	260	230,00	FG 196/A46	273	55,00	<b>FG 210/B</b>	<b>286</b>	<b>85,00</b>
FG 192/VW14	243	320,00	FG 193/AT1-2	260	95,00	FG 196/A56	273	66,00	FG 211	283	110,00
FG 192/VW14-1	243	31,20	FG 193/AT1-3	260	95,00	FG 196/AV	273	30,00	<b>FG 217</b>	<b>287</b>	<b>250,00</b>
FG 192/VW14-2	243	39,00	FG 193/AT1-4	260	380,00	FG 197/A36	194	40,00	FG 212	283	78,00
FG 192/VW14-3	243	46,80	FG 193/AT1-5	260	225,00	FG 197/B36	194	40,00	FG 213/LT	439	310,00
FG 192/VW14-6	243	11,70	FG 193/AT1-6	260	140,00	FG 197/BP	273	330,00	FG 213/SM	439	750,00
FG 192/VW14-7	243	19,50	FG 193/AT1-7	260	90,00	FG 197/F1	272	49,00	FG 213/SM1	439	590,00
FG 192/VW14-8	243	15,60	FG 193/AT1-8	260	600,00	FG 197/F2	272	27,00	FG 213/SU	439	630,00
FG 192/VW14-9	243	7,80	FG 193/AT2	260	750,00	FG 197/DA1	272	88,00	FG 215	204	950,00
FG 192/VW14-10	243	23,40	FG 193/AT2-1	260	180,00	FG 197/DA2	272	68,00	FG 215/S39	205	600,00
FG 192/VW14-12	243	31,20	FG 193/AT2-2	260	75,00	FG 197/IV1	272	240,00	FG 215/S40	206	1.550,00
FG 193/M5	189	0,60	FG 193/AT2-3	260	70,00	FG 197/IV2	272	242,00	FG 215/AD90	205	33,00
FG 193/M6	189	0,70	FG 193/AT2-4	260	55,00	FG 197/MA1	272	88,00	FG 215BE/M10	205	11,00
FG 193/M8	189	0,80	FG 193/AT2-5	260	55,00	FG 197/MB1	272	90,00	FG 215BE/M12	205	11,00
FG 193/M10	189	0,90	FG 193/AT2-6	260	60,00	FG 197/MB2	272	120,00	FG 215BE/M14	205	11,00
FG 193/M12	189	1,20	FG 193/AT2-7	260	30,00	FG 197/SC1	272	66,00	FG 215BE/M14F	205	22,00
FG 193/M14	189	1,50	FG 193/AT2-8	260	30,00	FG 197/VO1	272	88,00	FG 215BE/M16	205	11,00
FG 193/ATJ	262	45,00	FG 193/AT2-9	260	250,00	FG 197/VO2	272	77,00	FG 215BE/PR	205	70,00
FG 193/MB	262	65,00	FG 193/AT3	261	980,00	FG 195/S4B	191	90,00	FG 215/CA1	205	26,00
FG 193/S4	262	590,00	FG 193/AT3-1	261	120,00	FG 195/VW	191	22,50	FG 215/CA2	205	27,00
FG 193/R1	256	175,00	FG 193/AT3-2	261	230,00	FG 195/U	202	11,00	FG 215/CA3	205	27,00
FG 193/R2	256	175,00	FG 193/AT3-3	261	195,00	FG 196/A12	202	27,00	FG 215/CA4	205	30,00
FG 193/R3	256	42,00	FG 193/AT3-4	261	190,00	FG 197/A3	189	34,00	FG 215/CA5	205	30,00
FG 193/R4	256	46,00	FG 193/AT3-5	261	80,00	FG 197/A4	189	40,00	FG 215/CA6	205	30,00
FG 193/R5	256	18,00	FG 193/AT4	261	1.250,00	FG 197/A6	189	58,00	FG 215/CA7	205	30,00
FG 193/R6	256	35,00	FG 193/AT4-1	261	250,00	FG 197/B1	189	30,00	FG 215/CA8	205	30,00
FG 193/R7	257	24,00	FG 193/AT4-2	261	230,00	FG 197/B2	189	32,00	FG 215/CA9	205	30,00
FG 193/R8	257	35,00	FG 193/AT4-3	261	200,00	FG 197/B3	189	37,00	FG 215/CA10	205	32,00
FG 193/R9	257	30,00	FG 193/AT4-4	261	110,00	FG 198/A1	195	36,00	FG 215/CA11	205	32,00
FG 193/R10	257	35,00	FG 193/AT4-5	261	225,00	FG 198/A2	195	36,00	FG 215/CA12	205	33,00
FG 193/R11	257	24,00	FG 193/AT4-6	261	65,00	FG 198/B1	195	125,00	FG 215/CA13	205	34,00
FG 193/R12	257	95,00	FG 193/AT4-7	261	80,00	FG 198/A30	194	32,00	FG 215/CA14	205	35,00
FG 193/R13	257	46,00	FG 193/AT4-8	261	85,00	FG 198/A32	194	32,00	FG 215/CA15	205	35,00
FG 193/R13B	257	46,00	FG 193/UN	261	1.050,00	FG 198/A34	194	32,00	FG 215/CA16	205	40,00
FG 193/R14	257	52,00	FG 193/UN-1	261	66,00	FG 198/A35	194	34,00	FG 215/CA17	205	55,00
FG 193/R15	257	30,00	FG 193/UN-2	261	55,00	FG 198/A36	194	38,00	FG 215/CA19	205	56,00
FG 193/R16	257	88,00	FG 193/UN-3	261	77,00	FG 198/DF	198	350,00	FG 215/CA20	205	40,00
FG 193/R17	257	30,00	FG 193/UN-4	261	60,50	FG 198/DG	193	33,00	FG 215/CA21	205	55,00
FG 193/R18	257	86,00	FG 193/UN-5	261	60,50	<b>FG 198/PE</b>	<b>195</b>	<b>60,00</b>	FG 215/CA22	205	52,00
FG 193/R19	257	95,00	FG 193/UN-6	261	66,00	FG 198/S11	193	135,00	FG 215/FI23	205	42,00
FG 193/R20	257	125,00	FG 193/UN-7	261	66,00	FG 198/B4	194	98,00	FG 215/FI24	205	48,00
FG 193/R21	257	116,00	FG 193/UN-8	261	71,50	<b>FG 198/B7</b>	<b>193</b>	<b>16,50</b>	FG 215/FI25	205	54,00
						FG 198/B9	193	16,50			

CODE	PAGE	€/Pz	CODE	PAGE	€/Pz	CODE	PAGE	€/Pz	CODE	PAGE	€/Pz
FG 215/FI26	205	55,00	FG 544/3	119	225,00	FG 559/3	119	225,00	FG 600/IN9	17	14,80
FG 215MP/S9	205	195,00	FG 544/4	119	270,00	FG 560	116	70,00	FG 600/IN10	17	17,00
FG 215TU/BE	205	46,00	FG 542/4	119	282,00	FG 560/A	116	70,00	FG 600/IN11	17	18,50
FG 215/TU	205	105,00	FG 545/1	119	40,00	FG 561	116	150,00	FG 600/IN12	17	20,80
FG 219/S	207	3.200,00	FG 545/2	119	46,00	FG 562	116	58,00	FG 600/IN13	17	22,00
FG 220/BT	207	420,00	FG 545/3	119	49,00	FG 579	120	1.800,00	FG 600/IN14	17	25,50
FG 225/SK1.5	287	300,00	FG 545/4	119	52,00	FG 580/A	120	270,00	FG 600/IN15	17	29,00
FG 225/SK2.5	287	370,00	FG 546/A7	119	25,00	FG 580/B	120	370,00	FG 600/IN16	17	33,00
FG 234	288	105,00	FG 546/A8	119	25,00	FG 581/A	120	800,00	FG 600/IN17	17	41,00
FG 235	288	135,00	FG 546/A10	119	25,00	FG 581/B	120	1.320,00	FG 600/IN18	17	52,00
FG 236	289	335,00	FG 546/A12	119	25,00	FG 600/B5.5	16	6,50	FG 600/IN19	17	53,00
FG 236/SU	289	100,00	FG 546/A13	119	25,00	FG 600/B6	16	6,50	FG 600/IN20	17	64,00
FG 260	278	75,00	FG 546/A14	119	26,00	FG 600/B7	16	6,70	FG 600IN/SC13	17	182,00
FG 260/GP	278	185,00	FG 546/A15	119	28,00	FG 600/B8	16	7,00	FG 600IN/SP6	17	62,00
FG 260/RP	279	60,00	FG 546/A16	119	28,00	FG 600/B9	16	7,10	FG 600IN/SP9	17	110,00
FG 260PR/S1	279	23,00	FG 546/A17	119	28,00	FG 600/B10	16	7,30	FG 600IN/SP11	17	150,00
FG 260PR/S2	279	7,50	FG 546/A18	119	28,00	FG 600/B11	16	8,10	FG 600/L10	16	10,80
FG 260PR/S3	279	7,50	FG 546/A19	119	28,00	FG 600/B12	16	8,60	FG 600/L11	16	11,30
FG 260PR/S4	279	9,00	FG 547/A13	119	31,50	FG 600/B13	16	8,70	FG 600/L12	16	12,10
FG 261	279	130,00	FG 547/A14	119	31,50	FG 600/B14	16	10,20	FG 600/L13	16	12,50
FG 490/C500	276	45,00	FG 547/A15	119	31,50	FG 600/B15	16	11,50	FG 600/L14	16	13,50
FG 490/C800	276	55,00	FG 547/A16	119	31,50	FG 600/B16	16	12,10	FG 600/L15	16	14,50
FG 490/C1000	276	56,00	FG 547/A17	119	31,50	FG 600/B17	16	12,80	FG 600/L16	16	15,50
FG 490/PT	276	15,00	FG 547/A18	119	31,50	FG 600/B18	16	13,50	FG 600/L17	16	16,60
FG 490/TE	276	3,00	FG 547/A19	119	31,50	FG 600/B19	16	14,00	FG 600/L18	16	17,80
FG 491	276	20,00	FG 547/A21	119	35,00	FG 600/B20	16	15,30	FG 600/L19	16	19,00
FG 491/200	182	37,00	FG 547/A22	119	35,00	FG 600/B21	16	16,50	FG 600L/SC10	16	150,00
FG 491/1500	182	82,00	FG 547/A24	119	36,00	FG 600/B22	16	17,20	FG 601/B10	17	7,00
FG 491/AD1	182	35,00	FG 547/A27	119	42,00	FG 600/B23	16	18,50	FG 601/B11	17	7,00
FG 491/AD2	182	36,00	FG 547/A30	119	46,00	FG 600/B24	16	19,40	FG 601/B12	17	7,00
FG 491/AD550	182	125,00	FG 547/A32	119	50,00	FG 600/B25	16	20,50	FG 601/B13	17	7,50
FG 491/DF1500	182	135,00	FG 547/A34	119	60,00	FG 600/B26	16	22,00	FG 601/B14	17	8,10
FG 492/AL	192	245,00	FG 547/A36	119	68,00	FG 600/B27	16	23,50	FG 601/B15	17	9,20
FG 493/AL	277	45,00	FG 547/A41	119	88,00	FG 600/B28	16	24,50	FG 601/B16	17	9,20
FG 493/AL2	277	46,00	FG 548/A7	119	27,00	FG 600/B29	16	26,00	FG 601/B17	17	9,20
FG 493/AL3	277	55,00	FG 548/A8	119	27,00	FG 600/B30	16	28,50	FG 601/B18	17	9,20
FG 493/N	277	38,50	FG 548/A10	119	27,00	FG 600/B32	16	31,50	FG 601/B19	17	10,80
FG 494/A180	277	165,00	FG 548/A12	119	27,00	FG 600/B34	16	49,00	FG 601/B20	17	10,80
FG 494/S12	277	55,00	FG 548/A13	119	27,00	FG 600/B36	16	60,00	FG 601/B21	17	10,80
FG 495/FA1	276	9,50	FG 548/A14	119	27,00	FG 600/B38	16	70,00	FG 601/B22	17	14,00
FG 495/FA2	276	9,80	FG 548/A15	119	28,00	FG 600/B41	16	82,00	FG 601/B23	17	14,00
FG 495/FA3	276	10,20	FG 548/A16	119	28,00	FG 600/B46	16	110,00	FG 601/B24	17	14,00
FG 496/FP1	276	9,50	FG 548/A17	119	28,00	FG 600/B50	16	165,00	FG 601/B25	17	17,80
FG 496/FP2	276	9,70	FG 548/A18	119	28,00	FG 600/B55	16	260,00	FG 601/B27	17	17,80
FG 496/FP3	276	10,00	FG 548/A19	119	28,00	FG 600/B60	16	340,00	FG 601/B28	17	20,00
FG 497/OP1	276	6,30	FG 548/A21	119	33,00	FG 600/B65	16	440,00	FG 601/B30	17	20,00
FG 497/OP2	276	7,40	FG 548/A22	119	35,00	FG 600/B70	16	490,00	FG 601/B32	17	26,00
FG 497/OP3	276	7,60	FG 549/A13	119	33,00	FG 600/B75	16	570,00	FG 601/B34	17	26,00
FG 497/SP1	276	8,20	FG 549/A14	119	33,00	FG 600/B80	16	660,00	FG 601/B35	17	27,00
FG 497/SP2	276	9,00	FG 549/A15	119	33,00	FG 600/SC17	16	175,00	FG 601/B36	17	27,50
FG 497	276	11,60	FG 549/A16	119	33,00	FG 600/SC16	16	225,00	FG 601/B38	17	28,50
FG 528	116	415,00	FG 549/A17	119	34,00	FG 600/SC25	16	375,00	FG 601/B41	17	33,00
FG 531	116	205,00	FG 549/A18	119	34,00	FG 600/SP6	16	70,00	FG 601/B46	17	43,00
FG 533/2	116	230,00	FG 549/A19	119	34,00	FG 600/SP9	16	99,00	FG 601/B50	17	66,00
FG 536/1	116	230,00	FG 549/A21	119	38,00	FG 600/SP11	16	120,00	FG 601/B55	17	84,00
FG 536/2	116	250,00	FG 549/A22	119	38,00	FG 600/ST7	16	75,00	FG 601/B60	17	86,00
FG 536/3	116	255,00	FG 549/A24	119	40,00	FG 600/ST9	16	95,00	FG 601/B65	17	98,00
FG 537/AL1	118	1.450,00	FG 549/A27	119	43,00	FG 600/ST11	16	116,00	FG 601/B70	17	130,00
FG 537/AL2	118	1.600,00	FG 549/A30	119	46,00	FG 600/E6x8	19	10,00	FG 601/B75	17	145,00
FG 537/AL3	118	1.900,00	FG 549/A32	119	49,00	FG 600/E10x12	19	10,70	FG 601/B80	17	185,00
FG 539/AL1	118	2.750,00	FG 549/A34	119	60,00	FG 600/E14x18	19	11,60	FG 602/B6x7	18	4,30
FG 537/1	118	1.400,00	FG 549/A36	119	68,00	FG 600/E20x24	19	16,50	FG 602/B8x9	18	4,50
FG 538/1	118	800,00	FG 549/A41	119	88,00	FG 600E/S4	19	52,00	FG 602/B8X10	18	5,20
FG 538/2	118	880,00	FG 551/1	121	240,00	FG 600/IN1	17	7,50	FG 602/B10X11	18	5,20
FG 539/1	118	1.150,00	FG 552/1	121	275,00	FG 600/IN2	17	8,00	FG 602/B12X13	18	5,60
FG 543/DG1	117	630,00	FG 552/2	121	275,00	FG 600/IN3	17	9,50	FG 602/B14X15	18	6,80
FG 543/DG2	117	740,00	FG 552/3	121	310,00	FG 600/IN4	17	9,30	FG 602/B16X17	18	7,90
FG 546/DG	117	310,00	FG 553/1	121	295,00	FG 600/IN5	17	10,70	FG 602/B18X19	18	9,10
FG 547/DG	117	195,00	FG 558/2	121	220,00	FG 600/IN6	17	11,50	FG 602/B20X22	18	11,50
FG 544/1	119	245,00	FG 559/1	119	210,00	FG 600/IN7	17	13,50	FG 602/B21X23	18	13,00
FG 544/2	119	210,00	FG 559/2	119	220,00	FG 600/IN8	17	13,70	FG 602/B22X24	18	13,00

CODE	PAGE	€/Pz	CODE	PAGE	€/Pz	CODE	PAGE	€/Pz	CODE	PAGE	€/Pz
FG 602/B24X26	18	14,50	FG 604/A65	25	138,00	FG 605/A17	26	22,60	FG 613/A9	20	13,00
FG 602/B25X28	18	16,50	FG 604/A70	25	165,00	FG 605/A18	26	24,70	FG 613/A10	20	14,00
FG 602/B27X29	18	18,00	FG 604/A75	25	178,00	FG 605/A19	26	24,70	FG 613/A11	20	14,00
FG 602/B30X32	18	19,00	FG 604/A80	25	290,00	FG 605/ST9-B	26	180,00	FG 613/A12	20	15,80
FG 602/B34X36	18	43,00	FG 604/A85	25	328,00	FG 605/ST11-B	26	220,00	FG 613/A13	20	18,90
FG 602/B35X38	18	56,00	FG 604/A90	25	368,00	FG 605/B6	26	12,20	FG 613/A14	20	18,90
FG 602/B36X41	18	57,00	FG 604/A95	25	430,00	FG 605/B7	26	12,20	FG 613/A15	20	20,50
FG 602/B41X46	18	72,00	FG 604/A100	25	530,00	FG 605/B8	26	12,60	FG 613/A16	20	22,00
FG 602/B46X50	18	86,00	FG 604/A105	25	598,00	FG 605/B9	26	12,60	FG 613/A17	20	23,00
FG 602/SC8	18	56,00	FG 604/A110	25	619,00	FG 605/B10	26	12,60	FG 613/A18	20	24,00
FG 602/SC13	18	140,00	FG 604/A115	25	695,00	FG 605/B11	26	13,10	FG 613/A19	20	26,00
FG 602/SP6	18	42,00	FG 604/A120	25	988,00	FG 605/B12	26	13,90	FG 613/A20	20	27,00
FG 602/SP9	18	76,00	FG 604/A125	25	1.260,00	FG 605/B13	26	14,60	FG 613/A21	20	32,00
FG 602/SP13	18	152,00	FG 604/A130	25	1.490,00	FG 605/B14	26	15,20	FG 613/A22	20	34,00
FG 602/ST7	18	49,00	FG 604/A135	25	1.630,00	FG 605/B15	26	16,30	FG 613/A23	20	37,00
FG 602/ST9	18	73,00	FG 604/B24	25	25,00	FG 605/B16	26	17,30	FG 613/A24	20	39,90
FG 602/C6x7	19	5,00	FG 604/B27	25	26,00	FG 605/B17	26	19,10	FG 613/A25	20	44,00
FG 602/C8x9	19	5,00	FG 604/B30	25	32,00	FG 605/B18	26	20,00	FG 613/A26	20	47,00
FG 602/C10x11	19	5,50	FG 604/B32	25	34,00	FG 605/B19	26	21,00	FG 613/A27	20	52,50
FG 602/C12x13	19	6,50	FG 604/B36	25	45,00	FG 605/B21	26	30,00	FG 613/A28	20	54,60
FG 602/C14X15	19	7,20	FG 604/B41	25	55,00	FG 605/B22	26	30,00	FG 613/A30	20	63,00
FG 602/C16X17	19	10,20	FG 604/B46	25	72,00	FG 605/B24	26	36,00	FG 613/A32	20	67,00
FG 602/C18X19	19	10,50	FG 604/B50	25	85,00	FG 605/B27	26	48,00	FG 613/S9	20	175,00
FG 602/C20X22	19	14,00	FG 604/B55	25	99,00	FG 605/B30	26	68,00	FG 613/S11	20	205,00
FG 602/C21X23	19	14,00	FG 604/B60	25	110,00	FG 605/B32	26	70,00	FG 613/S17	20	345,00
FG 602C/SP6	19	49,00	FG 604/B65	25	139,00	FG 605/SC12	26	188,30	FG 614/A6x7	21	11,80
FG 602C/SP9	19	90,00	FG 604/B70	25	178,00	FG 605/SC15	26	245,00	FG 614/A8x9	21	14,00
FG 602/IN1	18	5,50	FG 604/B75	25	195,00	FG 605/SC19	26	465,00	FG 614/A10x11	21	15,00
FG 602/IN2	18	6,50	FG 604/B80	25	290,00	FG 605/SP6	26	105,00	FG 614/A12x13	21	17,50
FG 602/IN3	18	7,20	FG 604/B85	25	320,00	FG 605/SP9	26	150,00	FG 614/A14x15	21	19,00
FG 602/IN4	18	7,70	FG 604/B90	25	365,00	FG 605/SP11	26	182,00	FG 614/A16x17	21	21,00
FG 602/IN5	18	8,30	FG 604/B95	25	376,00	FG 606/B8	26	10,50	FG 614/A18x19	21	23,00
FG 602/IN6	18	10,30	FG 604/B100	25	522,00	FG 606/B9	26	11,00	FG 614/A20x22	21	26,00
FG 602/IN7	18	11,80	FG 604/B105	25	590,00	FG 606/B10	26	11,10	FG 614/A21x23	21	29,50
FG 602/IN8	18	13,50	FG 604/B110	25	645,00	FG 606/B11	26	11,10	FG 614/A24x26	21	35,00
FG 602/IN9	18	18,50	FG 604/B115	25	740,00	FG 606/B12	26	11,80	FG 614/A25x28	21	40,00
FG 602/IN10	18	21,50	FG 604/B120	25	770,00	FG 606/B13	26	12,30	FG 614/A27x29	21	46,00
FG 602/IN11	18	23,50	FG 604/B125	25	875,00	FG 606/B14	26	12,90	FG 614/A30x32	21	53,50
FG 602IN/SP9	18	115,00	FG 604/D24	25	46,00	FG 606/B15	26	14,20	FG 614/AS1	21	5,30
FG 603/E7	100	22,00	FG 604/D27	25	48,00	FG 606/B16	26	14,50	FG 614/AS2	21	7,00
FG 603/E8	100	22,00	FG 604/D30	25	52,00	FG 606/B17	26	15,80	FG 614/AS3	21	11,50
FG 603/E9	100	23,00	FG 604/D32	25	59,00	FG 606/B18	26	17,30	FG 614A/S8	21	150,00
FG 603/E10	100	24,00	FG 604/D36	25	65,00	FG 606/B19	26	17,60	FG 614A/S13	21	355,00
FG 603/E11	100	25,00	FG 604/D41	25	82,00	FG 606/SP6	26	90,00	FG 614/B6x7	21	5,30
FG 603/E12	100	25,00	FG 604/D46	25	90,00	FG 606/SP9	26	128,00	FG 614/B8x9	21	5,30
FG 603/E13	100	27,00	FG 604/D50	25	107,00	FG 609/A8x10	19	11,30	FG 614/B10x11	21	6,50
FG 603/E14	100	27,00	FG 604/D55	25	118,00	FG 609/A10x12	19	12,20	FG 614/B12x13	21	7,70
FG 603/E16	100	30,00	FG 604/D60	25	152,00	FG 609/A11x13	19	14,80	FG 614/B14x15	21	8,20
FG 603/E17	100	32,00	FG 604/D65	25	175,00	FG 609/A14x17	19	18,20	FG 614/B16x17	21	8,70
FG 603/E18	100	33,00	FG 604/D70	25	200,00	FG 609/A15x17	19	21,00	FG 614/B18x19	21	11,60
FG 603/E19	100	34,00	FG 604/D75	25	222,00	FG 609/A16x18	19	21,50	FG 614/B20x22	21	14,70
FG 603/EL	107	40,00	FG 604/D80	25	252,00	FG 609/A19x22	19	25,20	FG 614/B21x23	21	15,80
FG 603/EL1	107	150,00	FG 604/D85	25	258,00	FG 609A/S5	19	95,00	FG 614/B24x26	21	17,90
FG 603/GU9	107	115,00	FG 604/D90	25	462,00	FG 610/FL8	27	18,50	FG 614/B25x28	21	20,50
FG 603/GU10	107	115,00	FG 604/D95	25	494,00	FG 610/FL9	27	18,50	FG 614/B27x29	21	23,00
FG 603/SP6	100	170,00	FG 604/D100	25	525,00	FG 610/FL10	27	19,50	FG 614/B30x32	21	26,00
FG 603/SP9	100	250,00	FG 604D/PR1	25	33,00	FG 610/FL11	27	20,00	FG 614B/S8	21	70,00
FG 603/SP11	100	300,00	FG 604D/PR2	25	50,00	FG 610/FL12	27	21,00	FG 614B/S13	21	175,00
FG 603/SC12	100	326,00	FG 604D/PR3	25	71,00	FG 610/FL13	27	21,50	FG 615A/S6	27	130,00
FG 603/S26	107	850,00	FG 604D/PR4	25	95,00	FG 610/FL14	27	23,50	FG 615/B6x7	19	8,20
FG 603/TA1	107	270,00	FG 605/A6	26	15,30	FG 610/FL15	27	24,00	FG 615/B8x9	19	8,90
FG 604/A24	25	23,50	FG 605/A7	26	15,30	FG 610/FL16	27	25,50	FG 615/B10x11	19	10,50
FG 604/A27	25	27,00	FG 605/A8	26	15,30	FG 610/FL17	27	27,50	FG 615/B12x13	19	11,20
FG 604/A30	25	33,50	FG 605/A9	26	16,30	FG 610/FL18	27	28,50	FG 615/B14x15	19	12,60
FG 604/A32	25	34,50	FG 605/A10	26	16,80	FG 610/FL19	27	28,35	FG 615/B16x17	19	14,20
FG 604/A36	25	50,00	FG 605/A11	26	17,30	FG 610FL/SP6	27	148,00	FG 615/B18x19	19	16,80
FG 604/A41	25	57,00	FG 605/A12	26	17,90	FG 610FL/SP9	27	225,00	FG 615/B20x22	19	18,90
FG 604/A46	25	69,00	FG 605/A13	26	18,40	FG 610FL/SP11	27	270,00	FG 615/B21x23	19	21,50
FG 604/A50	25	82,00	FG 605/A14	26	19,40	FG 613/A6	20	13,00	FG 615/B24x26	19	24,10
FG 604/A55	25	93,00	FG 605/A15	26	20,50	FG 613/A7	20	13,00	FG 615/B24x27	19	25,70
FG 604/A60	25	112,00	FG 605/A16	26	22,60	FG 613/A8	20	13,00	FG 615/B25x28	19	27,80

CODE	PAGE	€/Pz	CODE	PAGE	€/Pz	CODE	PAGE	€/Pz	CODE	PAGE	€/Pz
FG 615/B27x29	19	29,50	FG 621/H5	23	18,50	FG 624/C6	38	4,50	FG 624/PA100	35	8,50
FG 615/B30x32	19	31,50	FG 621/H6	23	21,50	FG 624/C7	38	4,50	FG 624/PR50	35	6,80
FG 615/B34x36	19	61,00	FG 621/H7	23	21,50	FG 624/C8	38	4,70	FG 624/PR100	35	7,50
FG 615/B36x41	19	68,00	FG 621/H8	23	22,00	FG 624/C9	38	4,70	FG 624/PR150	35	8,20
FG 615/B46x50	19	128,00	FG 621/H9	23	25,00	FG 624/C10	38	4,70	FG 624/PRF150	35	12,00
FG 615/SC8	19	105,00	FG 621/H10	23	27,80	FG 624/C11	38	4,70	FG 624/Q14	35	38,00
FG 615/SC13	19	239,00	FG 621/H12	23	29,50	FG 624/C12	38	4,70	FG 624/Q38	43	42,00
FG 616/A8	21	17,00	FG 621/H14	23	38,00	FG 624/C13	38	4,70	FG 624/RT14	35	63,00
FG 616/A10	21	19,00	FG 621H/S8	23	139,00	FG 624/C14	38	4,80	FG 624/S11	30	42,00
FG 616/A12	21	21,50	FG 621H/S8B	23	132,00	FG 624/C15	38	4,90	FG 624/S12	30	80,00
FG 616/A13	21	22,00	FG 621H/S8C	23	152,00	FG 624/C16	38	4,90	FG 624/S18	31	135,00
FG 616/A14	21	23,00	FG 621H/S14	23	298,00	FG 624/C17	38	5,00	FG 624/S25	30	90,00
FG 616/A17	21	27,50	FG 621/TX6	24	15,80	FG 624/C18	38	5,20	FG 624/S25A	30	85,00
FG 616A/S6	21	132,00	FG 621/TX7	24	15,80	FG 624/C19	38	5,20	FG 624/S29	32	210,00
FG 617A/S7	27	165,00	FG 621/TX8	24	15,80	FG 624/C20	38	5,20	FG 624/S45	31	205,00
FG 618/A6	22	29,00	FG 621/TX9	24	15,80	FG 624/C21	38	5,60	FG 624/SN14	35	15,00
FG 618/A7	22	29,00	FG 621/TX10	24	15,80	FG 624/C22	38	5,60	FG 624/SN38	43	14,00
FG 618/A8	22	29,50	FG 621/TX15	24	15,80	FG 624/C24	38	6,20	FG 624/TX4	33	5,50
FG 618/A9	22	29,50	FG 621/TX20	24	15,80	FG 624C/INS23	40	230,00	FG 624/TX5	33	5,50
FG 618/A10	22	32,00	FG 621/TX25	24	16,80	FG 624C/S18	38	105,00	FG 624/TX6	33	5,50
FG 618/A11	22	32,50	FG 621/TX27	24	16,80	FG 624C/S22	38	210,00	FG 624/TX7	33	5,50
FG 618/A12	22	33,00	FG 621/TX30	24	16,80	FG 624/CS14	35	26,00	FG 624/TX8	33	5,50
FG 618/A13	22	36,00	FG 621/TX40	24	20,00	FG 624/CR14	35	40,00	FG 624/TX10	33	5,50
FG 618/A14	22	36,00	FG 621/TX45	24	23,00	FG 624/FR14	35	42,00	FG 624TX/S6	33	45,00
FG 618/A15	22	43,00	FG 621/TX50	24	25,00	FG 624E/CR38	102	145,00	FG 624TX/S17	33	76,00
FG 618/A16	22	43,00	FG 621TX/S8B	24	145,00	FG 624E/PR150	102	58,00	FG 624/U4	33	3,60
FG 618/A17	22	43,00	FG 621TX/S13	24	235,00	FG 624E/PR250	102	70,00	FG 624/U4.5	33	3,60
FG 618/A18	22	43,00	FG 622A/S2	27	80,00	FG 624E/T38	102	85,00	FG 624/U5	33	3,60
FG 618/A19	22	53,00	FG 622A/S6	27	130,00	FG 624E/S6	103	125,00	FG 624/U5.5	33	3,60
FG 618/A20	22	53,00	FG 622/H2	24	20,00	FG 624E/S10	103	450,00	FG 624/U6	33	3,60
FG 618/A21	22	53,00	FG 622/H2.5	24	20,00	FG 624E/S16	103	650,00	FG 624/U7	33	3,60
FG 618/A22	22	53,00	FG 622/H3	24	20,50	FG 624/CS38	43	33,00	FG 624/U8	33	4,00
FG 618/A23	22	53,00	FG 622/H3.5	24	20,50	FG 624/CR38	43	42,00	FG 624/U9	33	4,00
FG 618/A24	22	53,00	FG 622/H4	24	22,50	FG 624/E4	30	3,30	FG 624/U10	33	4,00
FG 618/S7B	22	245,00	FG 622/H4.5	24	22,50	FG 624/E5	30	3,30	FG 624/U11	33	4,00
FG 618/S7	22	265,00	FG 622/H5	24	24,00	FG 624/E6	30	3,30	FG 624/U12	33	4,00
FG 618/S10	22	385,00	FG 622/H6	24	26,00	FG 624/E7	30	3,30	FG 624/U13	33	4,00
FG 618/S18	22	726,00	FG 622/H7	24	26,00	FG 624/E8	30	3,30	FG 624/U14	33	4,10
FG 618/E6	23	34,00	FG 622/H8	24	32,00	FG 624/E9	30	3,30	FG 624U/S13	33	62,00
FG 618/E7	23	34,00	FG 622/H9	24	32,00	FG 624/E10	30	3,30	FG 624A/IN1	32	3,60
FG 618/E8	23	38,00	FG 622/H10	24	42,00	FG 624/E11	30	3,30	FG 624A/IN2	32	3,60
FG 618/E10	23	38,00	FG 622/H12	24	52,00	FG 624/E12	30	3,30	FG 624A/IN3	32	3,60
FG 618/E12	23	45,00	FG 622/H14	24	60,00	FG 624/E13	30	3,30	FG 624A/IN4	32	3,60
FG 618/E14	23	56,00	FG 622H/S6	24	155,00	FG 624/E14	30	3,50	FG 624A/IN5	32	3,60
FG 618/E16	23	56,00	FG 622H/S7	24	195,00	FG 624/ES14	35	7,00	FG 624A/IN6	32	3,60
FG 618/E18	23	57,00	FG 624/AD1	72	5,50	FG 624/ES38	43	13,00	FG 624A/IN7	32	3,60
FG 618/E20	23	57,00	FG 624/AD2	72	6,80	FG 624/GR14B	35	16,00	FG 624A/IN8	32	3,60
FG 618E/S9	23	418,00	FG 624/AD3	72	8,00	FG 624/GR14C	35	10,50	FG 624A/IN9	32	3,60
FG 619/H3	22	32,50	FG 624/AD4	73	12,00	FG 624/L6	39	8,00	FG 624A/IN10	32	3,60
FG 619/H4	22	32,50	FG 624/AD5	73	15,00	FG 624/L7	39	8,00	FG 624A/IN11	32	3,60
FG 619/H5	22	32,50	FG 624/AM1	72	9,00	FG 624/L8	39	8,00	FG 624A/IN12	32	3,60
FG 619/H6	22	39,50	FG 624/AM2	72	12,00	FG 624/L9	39	8,00	FG 624A/INS12	32	55,00
FG 619/H8	22	41,00	FG 624/B8	36	5,60	FG 624/L10	39	8,00	FG 624E/8	102	16,00
FG 619/H10	22	46,00	FG 624/B9	36	5,60	FG 624/L11	39	8,00	FG 624E/10	102	16,00
FG 619H/S5	22	182,00	FG 624/B10	36	5,60	FG 624/L12	39	8,00	FG 624E/12	102	16,50
FG 619H/S6	22	227,00	FG 624/B11	36	5,60	FG 624/L13	39	8,20	FG 624E/13	102	17,00
FG 619/TX20	23	38,00	FG 624/B12	36	5,60	FG 624/L14	39	8,80	FG 624E/14	102	18,00
FG 619/TX25	23	38,00	FG 624/B13	36	5,60	FG 624/L15	39	10,30	FG 624E/17	102	20,00
FG 619/TX27	23	38,00	FG 624/B14	36	5,80	FG 624/L16	39	10,30	FG 624E/19	102	22,00
FG 619/TX30	23	38,00	FG 624/B15	36	5,80	FG 624/L17	39	11,00	FG 624E/22	102	24,00
FG 619/TX40	23	42,00	FG 624/B16	36	6,00	FG 624/L18	39	11,50	FG 624B/L8	37	10,20
FG 619/TX45	23	44,00	FG 624/B17	36	6,00	FG 624/L19	39	11,50	FG 624B/L9	37	10,20
FG 619/TX50	23	47,00	FG 624/B18	36	6,00	FG 624/L20	39	12,00	FG 624B/L10	37	10,20
FG 619/TX55	23	51,00	FG 624/B19	36	7,00	FG 624/L21	39	12,00	FG 624B/L11	37	10,20
FG 619TX/S8	23	340,00	FG 624/B21	36	7,00	FG 624/L22	39	12,50	FG 624B/L12	37	10,20
FG 621/H2	23	14,30	FG 624/B22	36	7,00	FG 624/L24	39	13,00	FG 624B/L13	37	10,20
FG 621/H2,5	23	14,30	FG 624/B23	36	7,00	FG 624L/S18	39	198,00	FG 624B/L14	37	10,20
FG 621/H3	23	14,30	FG 624B/S15	36	115,00	FG 624L/S20	39	270,00	FG 624B/L15	37	11,50
FG 621/H3,5	23	14,30	FG 624B/S16	36	152,00	FG 624/MCH	35	36,00	FG 624B/L16	37	11,50
FG 621/H4	23	15,60	FG 624B/S22	36	230,00	FG 624/MCR	35	36,00	FG 624B/L17	37	11,50
FG 621/H4,5	23	16,80	FG 624B/TXS10	41	135,00	FG 624/PA50	35	8,00	FG 624B/L18	37	11,50

CODE	PAGE	€/Pz	CODE	PAGE	€/Pz	CODE	PAGE	€/Pz	CODE	PAGE	€/Pz
FG 624B/L19	37	11,50	FG 625/A14	44	5,00	FG 625/CR12	58	54,00	FG 625C/IN18	48	11,50
FG 624B/L21	37	13,50	FG 625/A15	44	5,00	FG 625/FR12	58	55,00	FG 625C/IN19	48	11,50
FG 624B/L22	37	13,50	FG 625/A16	44	5,00	FG 625E/CR12	100	155,00	FG 625IN/S11	48	75,00
FG 624B/L23	37	13,50	FG 625/A17	44	5,00	FG 625/CS12	58	42,00	FG 625IN/S24	48	270,00
FG 624L/S15	37	180,00	FG 625/A18	44	6,00	FG 625/ES12	58	16,00	FG 625L/A10	45	12,80
FG 624L/S16	37	220,00	FG 625/A19	44	6,00	FG 625/L8	47	10,00	FG 625L/A11	45	12,80
FG 624B/LS20	37	310,00	FG 625/A20	44	6,50	FG 625/L9	47	10,00	FG 625L/A12	45	12,80
FG 624B/PA75	43	10,00	FG 625/A21	44	6,50	FG 625/L10	47	10,00	FG 625L/A13	45	12,80
FG 624B/PA125	43	11,00	FG 625/A22	44	8,00	FG 625/L11	47	10,00	FG 625L/A14	45	12,80
FG 624B/PA150	43	14,50	FG 625/A23	44	8,70	FG 625/L12	47	10,00	FG 625L/A15	45	12,80
FG 624B/PA250	43	19,50	FG 625/A24	44	8,70	FG 625/L13	47	10,00	FG 625L/A16	45	13,20
FG 624B/S80	43	250,00	FG 625/A25	44	8,80	FG 625/L14	47	10,00	FG 625L/A17	45	13,20
FG 624B/TX5	41	6,50	FG 625/A26	44	8,90	FG 625/L15	47	10,00	FG 625L/A18	45	13,20
FG 624B/TX6	41	6,50	FG 625/A27	44	8,90	FG 625/L16	47	10,00	FG 625L/A19	45	13,20
FG 624B/TX7	41	6,50	FG 625/A30	44	9,10	FG 625/L17	47	10,00	FG 625L/A20	45	14,50
FG 624B/TX8	41	6,50	FG 625/A32	44	9,50	FG 625/L18	47	10,20	FG 625L/A21	45	14,50
FG 624B/TX10	41	6,50	FG 625A/S10	44	98,00	FG 625/L19	47	10,20	FG 625L/A22	45	16,20
FG 624B/TX12	41	6,50	FG 625A/S11	44	78,00	FG 625/L20	47	11,80	FG 625L/A23	45	18,20
FG 624B/TX14	41	6,50	FG 625A/S12	44	130,00	FG 625/L21	47	13,00	FG 625L/A24	45	19,00
FG 624B/TX16	41	6,50	FG 625A/S25	44	270,00	FG 625/L22	47	14,50	FG 625L/A25	45	19,00
FG 624TX/S8	41	60,00	FG 625A/S37	44	475,00	FG 625/L23	47	14,50	FG 625L/A26	45	19,00
FG 624C/IN1	40	5,50	FG 625E/10	101	21,00	FG 625/L24	47	14,50	FG 625L/A27	45	22,00
FG 624C/IN2	40	5,50	FG 625E/11	101	21,00	FG 625/L25	47	16,50	FG 625L/A28	45	25,00
FG 624C/IN3	40	5,50	FG 625E/12	101	21,00	FG 625/L27	47	19,00	FG 625L/A29	45	25,00
FG 624C/IN4	40	5,50	FG 625E/13	101	21,00	FG 625/L30	47	24,50	FG 625L/A30	45	26,00
FG 624C/IN5	40	5,50	FG 625E/14	101	21,00	FG 625/L32	47	25,50	FG 625L/A32	45	26,00
FG 624C/IN6	40	6,00	FG 625E/17	101	22,00	FG 625/L36	47	44,00	FG 625L/A36	45	44,00
FG 624C/IN7	40	6,00	FG 625E/19	101	23,50	FG 625L/S12	47	132,00	FG 625AL/S9	45	210,00
FG 624C/IN8	40	6,00	FG 625E/22	101	27,50	FG 625L/S6	47	120,00	FG 625AL/S11	45	160,00
FG 624C/IN9	40	6,50	FG 625E/24	101	28,50	FG 625/PA50	58	11,00	FG 625L/TX8	50	12,72
FG 624C/IN10	40	6,50	FG 625E/27	101	35,00	FG 625/PA75	58	13,00	FG 625L/TX10	50	13,50
FG 624C/IN11	40	6,50	FG 625E/32	101	43,00	FG 625/PA125	58	15,50	FG 625L/TX12	50	13,50
FG 624C/IN12	40	7,00	FG 625E/PR125	100	60,00	FG 625/PA250	58	20,00	FG 625L/TX14	50	13,50
FG 624C/IN13	40	7,00	FG 625E/PR250	100	75,00	FG 625/PR50	58	10,00	FG 625L/TX16	50	13,50
FG 624C/IN14	40	7,50	FG 625E/S5	101	125,00	FG 625/PR75	58	11,50	FG 625L/TX18	50	13,50
FG 624C/IN15	40	8,20	FG 625E/S12	101	550,00	FG 625/PR125	58	13,00	FG 625L/TX20	50	13,50
FG 624C/IN16	40	8,60	FG 625E/S20	101	820,00	FG 625/PR250	58	15,50	FG 625L/TX22	50	13,50
FG 624C/INS13	40	90,00	FG 625E/T12	100	90,00	FG 625/Q12	58	50,00	FG 625L/TX24	50	13,50
FG 624E/L4	32	7,00	FG 625/C8	46	5,00	FG 625/RT12	58	82,00	FG 625LTX/S9	50	130,00
FG 624E/L5	32	7,00	FG 625/C9	46	5,00	FG 625/SN12	58	22,00	FG 626/A8	49	7,00
FG 624E/L6	32	7,00	FG 625/C10	46	5,00	FG 625/SN12R	73	36,00	FG 626/A10	49	7,00
FG 624E/L7	32	7,00	FG 625/C11	46	5,00	FG 625/TX8	50	7,50	FG 626/A11	49	7,00
FG 624E/L8	32	7,50	FG 625/C12	46	5,00	FG 625/TX10	50	7,50	FG 626/A12	49	7,00
FG 624E/L9	32	7,50	FG 625/C13	46	5,00	FG 625/TX12	50	7,50	FG 626/A13	49	7,00
FG 624E/L10	32	7,50	FG 625/C14	46	5,00	FG 625/TX14	50	7,50	FG 626/A14	49	7,00
FG 624E/L11	32	7,50	FG 625/C15	46	5,00	FG 625/TX16	50	7,50	FG 626/A15	49	7,00
FG 624E/L12	32	7,50	FG 625/C16	46	5,00	FG 625/TX18	50	7,50	FG 626/A16	49	7,20
FG 624E/L13	32	7,50	FG 625/C17	46	5,00	FG 625/TX20	50	7,50	FG 626/A17	49	7,20
FG 624E/L14	32	7,50	FG 625/C18	46	6,00	FG 625/TX22	50	7,50	FG 626/A18	49	7,20
FG 624L/S11	32	95,00	FG 625/C19	46	6,00	FG 625/TX24	50	7,50	FG 626/A19	49	7,70
FG 624L/TX6	41	10,50	FG 625/C20	46	6,50	FG 625TX/S9	50	78,00	FG 626/A20	49	7,70
FG 624L/TX7	41	10,50	FG 625/C21	46	6,50	FG 625TX/S9B	52	75,00	FG 626/A21	49	7,70
FG 624L/TX8	41	10,50	FG 625/C22	46	8,00	FG 625TX/S23	52	225,00	FG 626/A22	49	8,00
FG 624L/TX10	41	10,50	FG 625/C23	46	8,70	FG 625TX/S13	52	160,00	FG 626/A23	49	8,50
FG 624L/TX12	41	10,50	FG 625/C24	46	8,70	FG 625C/IN1	48	5,50	FG 626/A24	49	8,50
FG 624L/TX14	41	10,50	FG 625/C25	46	8,80	FG 625C/IN2	48	5,50	FG 626/A27	49	10,50
FG 624L/TX16	41	10,50	FG 625/C26	46	8,90	FG 625C/IN3	48	5,50	FG 626/A30	49	12,00
FG 624L/TX18	41	10,50	FG 625/C27	46	8,90	FG 625C/IN4	48	5,50	FG 626/A32	49	13,00
FG 624L/TXS8	41	92,00	FG 625/C28	46	8,90	FG 625C/IN5	48	5,50	FG 626/S6	49	65,00
FG 625/AD1	72	10,00	FG 625/C29	46	8,90	FG 625C/IN6	48	5,50	FG 626/S13	49	105,00
FG 625/AD2	72	10,50	FG 625/C30	46	9,10	FG 625C/IN7	48	5,50	FG 626/S23	49	280,00
FG 625/AD3	72	12,00	FG 625/C32	46	9,50	FG 625C/IN8	48	5,50	FG 627/C8	66	6,00
FG 625AD/S10	72	75,00	FG 625/S11	46	75,00	FG 625C/IN9	48	5,50	FG 627/C9	66	6,00
FG 625/AM1	72	18,00	FG 625/S12	46	120,00	FG 625C/IN10	48	6,50	FG 627/C10	66	6,00
FG 625AM/S3	72	48,00	FG 625/S12B	46	92,00	FG 625C/IN11	48	7,00	FG 627/C11	66	6,00
FG 625/A8	44	5,00	FG 625C/S25	44	256,00	FG 625C/IN12	48	7,20	FG 627/C12	66	6,00
FG 625/A9	44	5,00	FG 625/S27	60	190,00	FG 625C/IN13	48	8,70	FG 627/C13	66	6,50
FG 625/A10	44	5,00	FG 625/S37	47	465,00	FG 625C/IN14	48	9,50	FG 627/C14	66	6,50
FG 625/A11	44	5,00	FG 625/S74	61	250,00	FG 625C/IN15	48	9,80	FG 627/C15	66	6,50
FG 625/A12	44	5,00	FG 625/S94	61	300,00	FG 625C/IN16	48	11,20	FG 627/C16	66	6,50
FG 625/A13	44	5,00	FG 625/S110	60	450,00	FG 625C/IN17	48	11,20	FG 627/C17	66	6,50

CODE	PAGE	€/Pz	CODE	PAGE	€/Pz	CODE	PAGE	€/Pz	CODE	PAGE	€/Pz
FG 627/C18	66	6,70	FG 628/LS19	66	430,00	FG 629/B26	62	16,00	FG 630/A33	71	35,00
FG 627/C19	66	6,70	FG 628/PR125	68	14,50	FG 629/B27	62	16,00	FG 630/A34	71	35,00
FG 627/C20	66	7,60	FG 628/PR250	68	15,50	FG 629/B28	62	16,50	FG 630/A36	71	35,00
FG 627/C21	66	7,60	FG 628/PR380	68	20,00	FG 629/B29	62	16,50	FG 630/A38	71	43,00
FG 627/C22	66	8,20	FG 628PR/S3	68	50,00	FG 629/B30	62	18,00	FG 630/A41	71	45,00
FG 627/S15B	66	120,00	FG 627/R17	195	28,00	FG 629/B32	62	18,00	FG 630/A46	71	49,00
FG 628/AD1	73	11,00	FG 627/R19	195	28,00	FG 629/B33	62	19,00	FG 630/A50	71	62,00
FG 628/AD2	73	12,00	FG 627/R21	195	28,00	FG 629/B34	62	19,00	FG 630/A55	71	67,00
FG 628/AD3	73	21,00	FG 627/S3	195	85,00	FG 629/B35	62	20,50	FG 630/A60	71	82,00
FG 628/C10	67	7,80	FG 628/R15	194	15,50	FG 629/B36	62	21,50	FG 630/A65	71	92,00
FG 628/C11	67	7,80	FG 628/R17	194	15,50	FG 629/B38	62	22,00	FG 630/A70	71	105,00
FG 628/C12	67	7,80	FG 628/R19	194	15,50	FG 629/B41	62	24,80	FG 630/A75	71	138,00
FG 628/C13	67	7,80	FG 628/R21	194	16,00	FG 629/B46	62	33,50	FG 630/A80	71	145,00
FG 628/C14	67	7,80	FG 628/R22	194	17,00	FG 629/B50	62	38,00	FG 630A/S14	71	830,00
FG 628/C15	67	9,00	FG 628/S3	194	50,00	FG 629/B55	62	47,00	FG 630/B36	65	35,00
FG 628/C16	67	9,00	FG 628/S5	194	78,00	FG 629/B60	62	55,00	FG 630/B41	65	35,00
FG 628/C17	67	9,00	FG 628/S7	194	115,00	FG 629B/S10	63	480,00	FG 630/B46	65	40,00
FG 628/C18	67	9,00	FG 628/TX8	67	11,00	FG 629B/S15	63	600,00	FG 630/B50	65	46,00
FG 628/C19	67	9,00	FG 628/TX10	67	11,00	FG 629/C17	70	22,00	FG 630/B55	65	50,00
FG 628/C20	67	9,00	FG 628/TX12	67	12,00	FG 629/C18	70	22,00	FG 630/B60	65	58,00
FG 628/C21	67	10,00	FG 628/TX14	67	12,00	FG 629/C19	70	22,00	FG 630/B65	65	77,00
FG 628/C22	67	10,00	FG 628/TX16	67	12,00	FG 629/C21	70	22,00	FG 630/B65	194	77,00
FG 628/C23	67	10,50	FG 628/TX18	67	12,00	FG 629/C22	70	22,00	FG 630/B70	65	82,00
FG 628/C24	67	10,50	FG 628/TX20	67	12,00	FG 629/C23	70	22,50	FG 630/B75	65	95,00
FG 628/C25	67	11,60	FG 628/TX22	67	13,00	FG 629/C24	70	22,50	FG 630/B80	65	102,00
FG 628/C26	67	12,80	FG 628/TX24	67	13,00	FG 629/C27	70	22,50	FG 630B/S8	65	1.125,00
FG 628/C27	67	13,00	FG 628TX/S9	67	110,00	FG 629/C28	70	22,50	FG 630/CR1	65	190,00
FG 628/C30	67	14,00	FG 628R/L17	194	26,00	FG 629/C30	70	22,50	FG 630/ES1	65	90,00
FG 628/C32	67	16,20	FG 628R/L19	194	26,00	FG 629/C32	70	23,50	FG 630/PR200	65	50,00
FG 628/S10	67	105,00	FG 628R/L21	194	26,00	FG 629/C33	70	25,50	FG 630/PR400	65	70,00
FG 628/S20	67	270,00	FG 628L/S3	194	98,00	FG 629/C34	70	25,50	FG 630/L24	71	58,00
FG 628/D10	68	8,50	FG 628L/TX10	68	13,00	FG 629/C36	70	27,00	FG 630/L27	71	60,00
FG 628/D11	68	8,50	FG 628L/TX12	68	13,00	FG 629/C40	70	32,00	FG 630/L30	71	60,00
FG 628/D12	68	8,50	FG 628L/TX14	68	13,00	FG 629/C41	70	32,00	FG 630/L32	71	61,00
FG 628/D13	68	8,50	FG 628L/TX16	68	14,00	FG 629/C46	70	38,00	FG 630/L33	71	63,00
FG 628/D14	68	8,50	FG 628L/TX18	68	14,00	FG 629/C50	70	48,00	FG 630/L34	71	68,00
FG 628/D15	68	9,50	FG 628L/TX20	68	15,00	FG 629/C54	70	50,00	FG 630/L36	71	68,00
FG 628/D16	68	9,50	FG 628L/TX22	68	15,00	FG 629/C55	70	52,00	FG 630/L41	71	74,00
FG 628/D17	68	9,50	FG 628L/TX24	68	15,00	FG 629/C58	70	60,00	FG 630/L46	71	79,00
FG 628/D18	68	9,50	FG 628L/TXS8	68	120,00	FG 629/C60	70	65,00	FG 630/L50	71	89,00
FG 628/D19	68	9,50	FG 629/AD1	73	29,00	FG 629C/S10	70	290,00	FG 630/L55	71	124,00
FG 628/D20	68	9,50	FG 629/AD2	73	33,00	FG 629/CR34	64	130,00	FG 630/L60	71	143,00
FG 628/D21	68	10,50	FG 629/AD3	72	15,00	FG 629/CR34R	64	50,00	FG 630/L65	71	163,00
FG 628/D22	68	10,50	FG 629/AS1	73	5,00	FG 629/ES34	64	42,00	FG 630/L70	71	185,00
FG 628/D23	68	11,20	FG 629/SN34R	73	70,00	FG 629/L17	70	33,00	FG 631/KM4	69	46,00
FG 628/D24	68	11,20	FG 629/A19	62	13,50	FG 629/L19	70	33,00	FG 631/KM5	69	50,00
FG 628/D27	68	13,50	FG 629/A22	62	14,00	FG 629/L21	70	33,00	FG 631/KM6	69	60,00
FG 628/D30	68	14,50	FG 629/A23	62	14,00	FG 629/L22	70	33,00	FG 631/KM7	69	70,00
FG 628/D32	68	17,00	FG 629/A24	62	15,50	FG 629/L24	70	33,00	FG 631/KM8	69	70,00
FG 628/R18.5	195	20,00	FG 629/A26	62	16,00	FG 629/L26	70	33,00	FG 631/KM9	69	80,00
FG 628/S12	68	130,00	FG 629/A27	62	16,00	FG 629/L27	70	33,00	FG 631/KM10	69	95,00
FG 628/S6	68	95,00	FG 629/A28	62	16,50	FG 629/L30	70	35,00	FG 631/KM11	69	95,00
FG 628/L10	66	14,50	FG 629/A29	62	16,50	FG 629/L32	70	35,00	FG 631/KM12	69	103,00
FG 628/L11	66	14,50	FG 629/A30	62	18,00	FG 629/L33	70	39,00	FG 631/S9	69	730,00
FG 628/L12	66	14,50	FG 629/A32	62	18,00	FG 629/L34	70	42,00	FG 632/KM4	69	45,00
FG 628/L13	66	14,50	FG 629/A33	62	19,00	FG 629/L36	70	45,00	FG 632/KM5	69	48,00
FG 628/L14	66	14,50	FG 629/A34	62	19,00	FG 629/L38	70	45,00	FG 632/KM6	69	57,00
FG 628/L15	66	14,50	FG 629/A35	62	20,50	FG 629/L41	70	52,00	FG 632/KM7	69	65,00
FG 628/L16	66	14,50	FG 629/A36	62	21,50	FG 629/L46	70	62,00	FG 632/KM8	69	70,00
FG 628/L17	66	14,50	FG 629/A38	62	22,00	FG 629/L50	70	72,00	FG 632/KM9	69	80,00
FG 628/L18	66	18,00	FG 629/A41	62	24,80	FG 629/PR200	64	28,00	FG 632/KM10	69	90,00
FG 628/L19	66	18,00	FG 629/A46	62	33,50	FG 629/PR400	64	42,00	FG 632/KM11	69	90,00
FG 628/L21	66	19,00	FG 629/A50	62	38,00	FG 629/PRL	64	42,00	FG 632/KM12	69	95,00
FG 628/L22	66	19,00	FG 629/A55	62	47,00	FG 629/QS34	64	65,00	FG 632/S9	69	770,00
FG 628/L23	66	20,00	FG 629/A60	62	55,00	FG 629/SN34	64	65,00	FG 710/A	440	95,00
FG 628/L24	66	20,00	FG 629A/S10	63	480,00	FG 630/AD1	73	45,00	FG 710/B	440	120,00
FG 628/L25	66	24,00	FG 629A/S15	63	600,00	FG 630/AS1	73	7,00	FG 710/C	440	150,00
FG 628/L27	66	24,00	FG 629/B19	62	13,50	FG 630/A24	71	34,00	FG 710/D	440	245,00
FG 628/L29	66	32,00	FG 629/B22	62	14,00	FG 630/A27	71	34,00	FG 712/A	281	50,00
FG 628/L30	66	32,00	FG 629/B23	62	14,00	FG 630/A30	71	34,00	FG 712/L4	281	120,00
FG 628/L32	66	32,00	FG 629/B24	62	15,50	FG 630/A32	71	35,00	FG 718/2.5T	437	470,00

CODE	PAGE	€/Pz	CODE	PAGE	€/Pz	CODE	PAGE	€/Pz	CODE	PAGE	€/Pz
FG 718/3.5T	437	560,00	FGA 307/AN	165	340,00	FGA 340	168	295,00	FGA 381/4	170	11,50
FG 719/2T	436	740,00	FGA 307AN/KIT	172	30,00	FGA 340/B	168	295,00	FGA 381/5	170	11,50
FG 722/5T	438	1.420,00	FGA 309	160	300,00	FGA 340/KIT	174	30,00	FGA 381/6	170	12,50
FG 725/3T	438	95,00	FGA 309/KIT	172	45,00	FGA 341	168	650,00	FGA 381/7	170	12,50
FG 725/6T	438	160,00	FGA 309/S4	162	360,00	FGA 341/R1	168	33,00	FGA 381/1N	170	10,00
FG 725/12T	438	280,00	FGA 309/S10	162	395,00	FGA 341/R2	168	22,00	FGA 381/2N	170	10,00
FG 735/4T	438	85,00	FGA 312	161	380,00	FGA 341/R3	168	22,00	FGA 381/3N	170	10,50
FG 735/6T	438	98,00	FGA 312/KIT	172	45,00	FGA 341/R4	168	22,00	FGA 381/4N	170	10,80
FG 735/10T	438	140,00	FGA 316	163	760,00	FGA 341/R5	168	22,00	FGA 381/5N	170	10,80
FG 735/16T	438	160,00	FGA 316/L	163	830,00	FGA 341/R6	168	22,00	FGA 383/AR15	169	270,00
FG 735/20T	438	200,00	FGA 316/KIT	172	100,00	FGA 341/KIT	174	20,00	FGA 382/B10	169	65,00
FG 738/1T	435	1.100,00	FGA 319	163	1.150,00	FGA 342	168	220,00	FGA 382/B15	169	80,00
FG 740/0.5T	439	600,00	FGA 319/L	163	1.250,00	FGA 342/B	168	285,00	FGA 382/B20	169	90,00
FG 745/CMF	435	460,00	FGA 319/KIT	172	100,00	FGA 342/KIT	174	20,00	FGA 384/B15	169	100,00
FG 745/CMR	435	950,00	FGA 321	163	1.050,00	FGA 342/R120	168	22,00	FGA 383	169	75,00
FG 748/0.5T	438	250,00	FGA 321/B	163	1.100,00	FGA 342/R180	168	22,00	FGA 383/2	169	80,00
FG 750/A	438	420,00	FGA 321/C	163	1.220,00	FGA 342/R320	168	22,00	FGA 383/3	169	90,00
FG 750/1P	434	2.600,00	FGA 322	165	140,00	FGA 342/R1000	168	27,00	FGA 385/AR15	169	360,00
FG 750/2P	434	3.300,00	FGA 322/KIT	173	28,00	FGA 342/R1500	168	27,00	FGA 384/R1	169	10,00
FG 752/1P	434	3.400,00	FGA 322/R2	165	33,00	FGA 342/R1500	168	27,00	FGA 384/R2	169	11,00
FG 752/2P	434	4.100,00	FGA 330	166	295,00	FGA 342/RT120	168	55,00	FGA 385	170	135,00
FG 800/2	190	120,00	FGA 330/24T	166	47,00	FGA 342/RT180	168	55,00	FGA 386	170	135,00
FG 800/3	190	120,00	FGA 330/32T	166	47,00	FGA 342/RT320	168	55,00	FGA 387	170	135,00
FG 800/5	190	120,00	FGA 330/KIT	173	30,00	FGA 342/RT1000	168	55,00	FGA 388/OL	171	16,00
FG 800/6	190	120,00	FGA 332	166	145,00	FGA 342/RT1500	168	55,00	FGA 390	165	140,00
FG 800/7	190	120,00	FGA 332/KIT	173	28,00	FGA 342/T120	168	60,00	FGA 416	170	19,00
FG 800/8	190	120,00	FGA 332/AN	166	180,00	FGA 342/T180	168	60,00	FGA 419	170	20,00
FG 800/9	190	145,00	FGA 332AN/KIT	173	28,00	FGA 342/T320	168	60,00			
FG 1425	299	102,00	FGA 333	166	185,00	FGA 342/T1000	168	72,00			
FG 1426	299	120,00	FGA 333/KIT	173	28,00	FGA 342/T1500	168	72,00			
FG 1427	299	170,00	FGA 333/AC	173	210,00	FGA 343/N10	169	220,00			
FG 1432	301	130,00	FGA 334	167	145,00	FGA 343/N20	169	285,00			
FG 1433	301	190,00	FGA 334/KIT	173	35,00	FGA 343N10/KIT	169	20,00			
FG 1434	300	145,00	FGA 334/AN	167	185,00	FGA 343N20/KIT	169	20,00			
FG 1434/EF	300	15,00	FGA 334AN/KIT	173	35,00	FGA 345	169	320,00			
FG 1434/V1	300	1,50	FGA 334/AN115	167	185,00	FGA 345/M	169	10,50			
FG 1434/V2	300	2,00	FGA334AN115/KIT	173	35,00	FGA 345/S1	169	12,00			
FG 1434/V3	300	4,00	FGA 334/L	167	185,00	FGA 345/S2	169	12,00			
FG 1434/V4	300	3,50	FGA 334L/KIT	173	35,00	FGA 345/S3	169	18,00			
FG 1434/V5	300	4,00	FGA 335	166	210,00	FGA 345/S4	169	13,50			
FG 1434/V6	300	6,50	FGA 335/KIT	173	22,00	FGA 345/S5	169	9,50			
FG 1434/V7	300	9,00	FGA 336	166	585,00	FGA 345/SC	169	110,00			
FG 1438/S4B	301	680,00	FGA 336/KIT	173	35,00	FGA 345/KIT	174	20,00			
FG 1438/S4C	301	730,00	FGA 337	168	125,00	FGA 346/A	168	145,00			
FG 1440	302	60,00	FGA 337/R1	168	16,00	FGA 346/B	168	220,00			
FG 1440/V1	302	3,00	FGA 337/KIT	174	28,00	FGA 376/1	171	6,50			
FG 1440/V2	302	4,00	FGA 338	167	125,00	FGA 376/2	171	6,50			
FG 1445	302	45,00	FGA 338/KIT	174	28,00	FGA 377/1	171	25,50			
FG 1445/V1	302	3,00	FGA 338/B	167	160,00	FGA 377/2	171	21,00			
FG 1445/D	302	5,50	FGA 338B/KIT	174	28,00	FGA 377/3	171	25,50			
FG 141010	202	300,00	FGA 338/AN	167	170,00	FGA 378/1	171	10,00			
FG 141015	202	80,00	FGA 338AN/KIT	174	28,00	FGA 378/2	171	10,00			
FG 141065	202	30,00	FGA 338/L	167	165,00	FGA 379/1	171	33,00			
FG 141060-BO	202	10,00	FGA 338L/KIT	174	28,00	FGA 379/2	171	31,00			
FG 141060-MA	202	12,00	FGA 338/MO1	139	6,00	FGA 379/3	171	33,00			
FGA 290	164	185,00	FGA 338/MO2	139	6,00	FGA 380	169	65,00			
FGA 290/KIT	172	20,00	FGA 338/MO3	139	6,00	FGA 380/SN	171	20,00			
FGA 291	164	170,00	FGA 338/MO4	139	6,00	FGA 380/1	170	4,20			
FGA 291/KIT	172	30,00	FGA 338/MO5	139	6,00	FGA 380/2	170	3,30			
FGA 291/B	164	122,00	FGA 338/MO6	139	6,00	FGA 380/3	170	3,30			
FGA 291/C	164	135,00	FGA 338/MO7	139	6,00	FGA 380/4	170	4,20			
FGA 292/B	164	215,00	FGA 338/MO8	139	6,00	FGA 380/5	170	3,30			
FGA 292B/KIT	173	30,00	FGA 338/MO9	139	6,00	FGA 380/6	170	3,30			
FGA 302	161	240,00	FGA 338/MO10	139	6,00	FGA 380/1N	170	4,00			
FGA 302/KIT	172	30,00	FGA 339	166	355,00	FGA 380/2N	170	3,10			
FGA 302/S4	162	285,00	FGA 339/KIT	174	40,00	FGA 380/3N	170	3,10			
FGA 302/S10	162	340,00	FGA 339/B	166	190,00	FGA 380/4N	170	4,00			
FGA 304	164	245,00	FGA 339/B-G60	166	9,00	FGA 380/5N	170	3,10			
FGA 304/KIT	172	32,00	FGA 339/B-G80	166	10,00	FGA 380/6N	170	3,10			
FGA 307	160	250,00	FGA 339/B-G120	166	12,00	FGA 381/1	170	10,50			
FGA 307/KIT	172	30,00	FGA 339B/KIT	174	28,00	FGA 381/2	170	10,50			
						FGA 381/3	170	11,00			

DESCRIPTION	SECTION	PAGE
<b>A</b>		
ABS tool cases and polypropylene cases	14	299
Accessories for tool trolleys	15	321
Adjustable pliers	3	94
Adjustable self-locking pliers, Heavy duty series	3	96
Adjustable self-locking pliers, Light series	3	96
Adjustable wrenches	13	292
Air die grinders	10	167
Air impact wrenches	10	160
Air ratchet wrenches	10	164
Air riveting tools	10	166
Air sanders	10	168
Allen keys	3	83
Angle screwdrivers	3	78
Angle torque meter	5	116
Assortment of tools for cases	14	306
Assortments of tools in EVA forms	15	333
Assortments of tools in in plastic tray	15	345
<b>B</b>		
Beams	8	146
Bending tools	13	293
Bits	3	85
Bolt cutters	7	438
Booster	11	202
Bottle jacks	17	432
<b>C</b>		
Cabinets	15	304
Cable cutters	4	106
Cable strippers	4	105
Calipers	9	156
Chisels	6	125
Circlip pliers	3	95
Circuit tester	4	105
Club hammers	6	124
Clutch centering tools	11	191
Combination wrenches	1	16
Crimping pliers and accessories	4	108
Cutter and scissors	7	130
Dead-blow hammers	6	124
<b>D</b>		
Dial gauges	9	157
Digital Automotive testers	11	204
Digital thermometer	9	157
Digital torque wrench	5	117
Double end box wrenches	1	19
Double open end wrenches	1	17
Drilling tools	7	138
<b>E</b>		
Engine crankshaft rotators for Trucks	11	272
Engine brackets	17	438
Engine crane	17	435
Engine stand	17	435
Engineer's hammers	6	124
Expanders	8	149
Extractors for broken screws	8	150
<b>F</b>		
Flaring tools	13	283
Fuel tank ring nuts wrenches	11	186
Furniture for vans	16	390
<b>G</b>		
Gear wrenches	1	26
Generic tools for automatic gear boxes	11	256
Generic tools for Trucks	11	272
Glow plugs and spark plugs tools	11	188

Glue gun	12	277
Grease guns and caulking gun	12	276
<b>H</b>		
Hacksaws	7	132
Hex screwdrivers	3	80
Hook wrenches	1	24
Hooks	15	361
Hoses for pneumatic tools	10	170
Hub nut tools	11	194
Hub nuts socket for Trucks	11	273
Hub nuts sockets	11	194
<b>I</b>		
Impact screwdrivers and bits	3	89
Impact sockets and accessories - 1"dr.	2	71
Impact sockets and accessories - 1/2"dr.	2	66
Impact sockets and accessories - 1/4"dr.	2	73
Impact sockets and accessories - 3/4"dr.	2	70
Impact sockets and accessories - 3/8"dr.	2	72
Individual EVA forms of tools	15	324
Individual plastic tray of tools	15	339
Insulated cutting tools	4	106
Insulated pliers	4	106
Insulated screwdrivers - 1000V	4	104
Insulated sockets and accessories - 1/2"dr.	4	101
Insulated sockets and accessories - 3/8"dr.	4	102
Insulated wrenches	4	100
Internal extractors and accessories	8	145
<b>J</b>		
Jack stand	17	438
<b>K</b>		
Key wrenches with handle	3	86
<b>L</b>		
Leather tool bag	14	303
Led lamps	12	276
Levers	12	272
Long and extra long nose pliers	3	94
<b>M</b>		
Magnetic pick-up tools and telescopic mirrors	12	273
Masonry chisels and points	6	126
Measuring tapes	9	154
Micro-pliers	4	110
Micro-screwdrivers	4	109
Micrometers	9	157
<b>N</b>		
Nut spinner	3	82
Nut splitter	8	150
Nylon bags	14	303
<b>O</b>		
Offset wrenches	1	25
<b>P</b>		
Pipe wrenches	1	20
Pitch gauge	9	156
Pliers with PVC handles	3	93
Power tools	11	196
Pre-set torque wrenches	5	121
Protactors	9	157
Puller with 2 jaws	8	144
Puller with 3 jaws	8	145
Punches, pin-punches and centre-punches	6	126



<b>R</b>	<b>SECTION</b>	<b>PAGE</b>
Riveting tools	12	279
<b>S</b>	<b>SECTION</b>	<b>PAGE</b>
Separators	8	149
Shears	7	131
Slogging wrenches	1	25
Slotted and Phillips screwdrivers	3	76
Socket wrenches and accessories - 1/2"	2	44
Socket wrenches and accessories - 3/8"	2	36
Sockets and accessories - 1"dr.	2	65
Sockets and accessories - 1/4"dr.	2	30
Sockets and accessories - 3/4"dr.	2	62
Soft-run pliers	3	92
Soldering tools	12	280
Special Automotive pliers	11	200
Special Automotive pullers	11	184
Special fittings for automatic transmission oil	11	256
Special kit for bearings and Silent -blocks	11	198
Special pullers for automatic gear boxes	11	260
Special tools for alternators	11	191
Special tools for car body repair shops	11	264
Special tools for Diesel injectors	11	185
Special tools for liquids' changing	11	192
Special tools for oil filters and oil drain plugs	11	178
Special tools for tyre shops	11	193
Special workbenches	15	350
Spirit levels	9	155
Squares	9	155
<b>T</b>	<b>SECTION</b>	<b>PAGE</b>
T-Handle wrenches	1	21
T-Handle wrenches with hex sockets	1	22
Tamper Resistant Torx screwdrivers	3	84
Threading and drilling air tools	10	166
Threading tools	7	134
Tool carrying trolley	15	365
Tool cases	14	304
Tool chests	14	302
Tool trolley - model FG 100	15	314
Tool trolley - model FG 101	15	318
Tool trolley - model FG 102	15	316
Tool trolley - model FG 104	15	316
Tool trolley - model FG 105	15	320
Tool trolley - model FG 109	15	321
Tool trolley - model FG 150	15	322
Tool trolley - model FG 160	15	323
Tools for brakes	11	193
Tools for material processing	7	132
Tools' panels	15	360
Torque bars with female drive and accessories	5	119
Torque multipliers	5	120
Torque screwdrivers	5	119
Torque tester cells	5	120
Torque wrenches	5	116
Torx screwdrivers	3	79
Tube cutters and pipe cutters	7	131
Tube wrenches	1	21
Trolley jacks	17	436
<b>U</b>	<b>SECTION</b>	<b>PAGE</b>
Under car beds and seat	17	440
<b>V</b>	<b>SECTION</b>	<b>PAGE</b>
Vice benches	12	278

<b>W</b>	<b>SECTION</b>	<b>PAGE</b>
Wire stripping pliers	4	105
Workbenches - simple version with steel worktop	15	350
Workbenches equipped with cabinets	15	354
Workbenches with wooden worktop	15	358









Fasangas S.r.l.  
Viale Grecia, 3  
73100 Zona Ind.le Lecce (Le) - ITALY  
Tel.: (+39).0832.362097/364265  
Cod. Fisc. e P.IVA: 03496900758  
Capitale Sociale: 465.000,00 euro  
REA C.C.I.A.A. Lecce N.225553  
Azienda certificata ISO 9001:2015

info@fasanotools.com  
www.fasanotools.com

## SALES CONDITION

### 1) ORDERS

Orders are taken under the following conditions which are accepted by the buyer with the order. Any exceptions must be agreed by the parties in writing, and only for sales they refer to. The orders are irrevocable by the buyer without the possibility of further additions. Fasangas Ltd may accept the order sent by the buyer by shipment of the goods, even several times, in accordance with art. 1327 Civil Code

### 2) PRODUCTS FEATURES

The weights, dimensions, pricing, packaging, colors, and other data in the catalogs, brochures, circulars and other documents illustrative of the nature of the seller's rough indication.

Fasangas reserves to change at any time and without notice, the specifications and construction of its products.

### 3) PRICES

Prices are quoted net of VAT, any taxes or fees, as well as taxes, fees and charges or tax of any kind may be levied on the contract. They refer to a commodity warehouse to Fasangas Srl.

The agreed prices are calculated based on the price list in force at the time of order.

Fasangas Srl reserves the right to change prices without notice.

### 4) PAYMENTS

Unless otherwise agreed in writing, payment must be made in cash, the immediate benefit of Fasangas Ltd, at the headquarters of the seller and the terms specified in the invoice.

In case of delayed payment, the buyer is obliged to pay to Fasangas Srl default interest pursuant to Legislative Decree no. 231/02 and result in the loss to the buyer the benefit of the term under art. 1186 cc, making it immediately due any amounts not yet expired.

### 5) SHIPMENTS

The shipment is the buyer's responsibility. The goods always travel and risk of the buyer, at the latest, by the time of delivery to the carrier. Therefore, Fasangas Srl is not responsible for deterioration, damage, delays, fines or other interference with or damage of any kind which may be involved during transport. Purchaser must perform due diligence in the goods and forward complaints to the carrier. Shipments will be supported to the carrier specified by the customer or, failing that, to the carrier cheaper than knowledge Fasangas Srl

### 6) DELIVERY

The delivery of the goods, however and wherever provided, are only indicative and not binding on the seller. The buyer, however, has the right to withdraw, in writing, if the delivery is not given within six months from the agreed date, in addition to this right of withdrawal, no pretense, not damages, may be made by the purchaser.

It is not considered due to Fasangas Srl any delay due to force majeure or acts or omissions of the buyer.

### 7) WARRANTY

The warranty covers manufacturing defects and is limited to replacement or repair of defective products from Fasangas Srl, with the exclusion of any right to compensation. And of course, therefore, that this warranty covers and replaces any warranty or liability of Fasangas Srl (contract or tort) may arise from the products supplied. The guarantee does not apply to products that have normal wear, signs of tampering or misuse.

The assessment of the quality or defective goods or parts will be made by Fasangas Ltd at its service center or authorized service technician.

Any return of goods must be authorized

in advance.

The cost of transporting the products to be replaced or repaired and replaced or repaired product shall be borne by the buyer.

### 8) COMPLAINTS

The buyer must notify, in writing by registered letter with return receipt, any defects of products supplied or the possible lack or uneven delivery of all or part of the purchase order, under penalty of forfeiture, within eight days to be calculated respectively the date of delivery of products (apparent defects) and / or the discovery of defects (hidden defects).

It is understood that any complaints or claims do not entitle the buyer to suspend or delay payment of the goods in dispute, nor, still less of other supplies.

The warranty does not work if the buyer has performed or carry out third party products.9) RESI

Eventuali resi di merce vengono accettati solo se preventivamente concordati e autorizzati per iscritto, contrariamente saranno respinti al mittente con trasporto a carico dell'acquirente.

### 10) TERMINATION

The insolvency of the buyer, even if not judicially determined, el'inadempimento even one of the obligations to him under the contract of sale, determine the ipso jure termination of the agreement, resulting Fasangas Srl right to full compensation for the damage and Fasangas Srl, with the power to demand the return of the products supplied.

### 11) JURISDICTION

Any controversy arising from or in connection with the contract shall have exclusive jurisdiction to the Court of Lecce.

## OFFICIAL DISTRIBUTOR

---



---

### FASANGAS S.r.l.

Viale Grecia 3, Lotto 18  
73100 Zona Industriale LECCE (LE) ITALY  
(+39) 0832.362097/364265  
[info@fasanotools.com](mailto:info@fasanotools.com)

**FASANOTOOLS.COM**

